

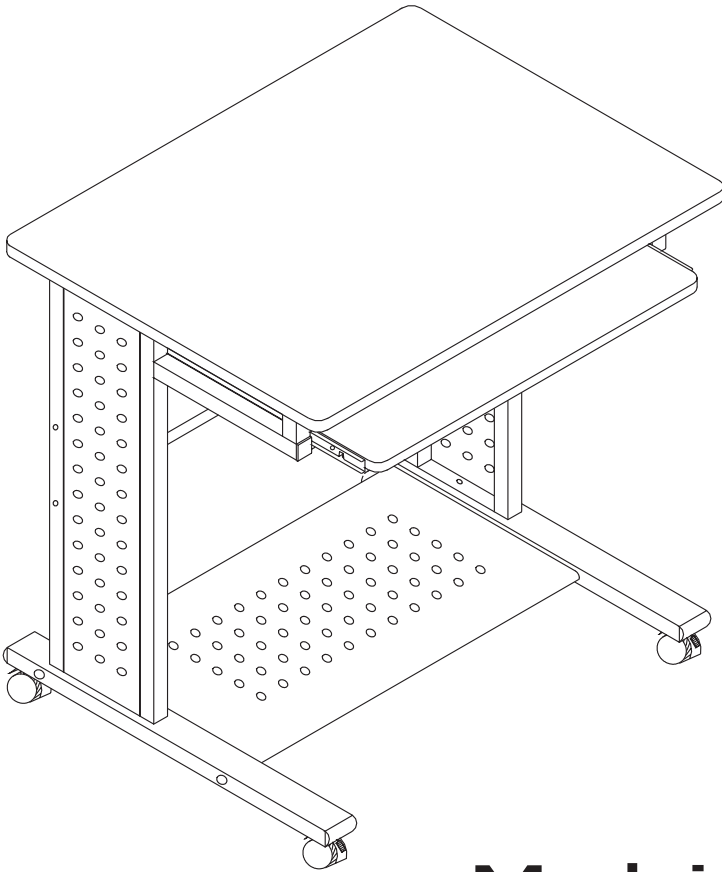

Tiffany Industries™
A MAYLINE GROUP COMPANY

Model No. 945











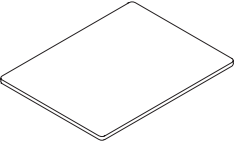
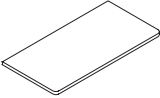
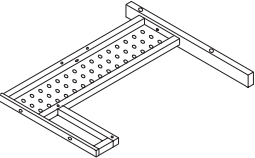
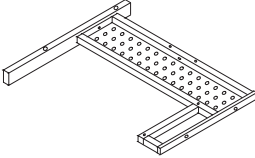
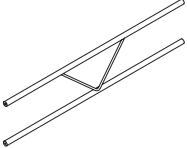
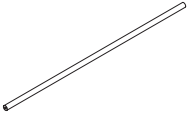
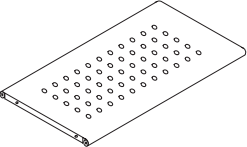
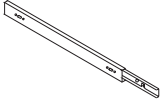
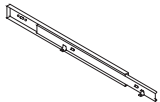

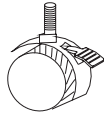
Mobile PC Station



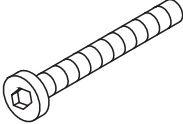
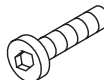

ASSEMBLY INSTRUCTIONS

CALL 1-800-822-8037 FOR ASSISTANCE

PARTS LIST

Name	Part	Qty.
A		1
B		1
C		1
D		1
E		1
F		2
G		1
L		1
R		1

Name	Part	Qty.
H		2
I		2
J		2
K		4
M		5
N		5
O		5
P		5
Q		5
S		1
T		1

M		
N		
O		
P	3/16"*12	
Q	M4*10	

1

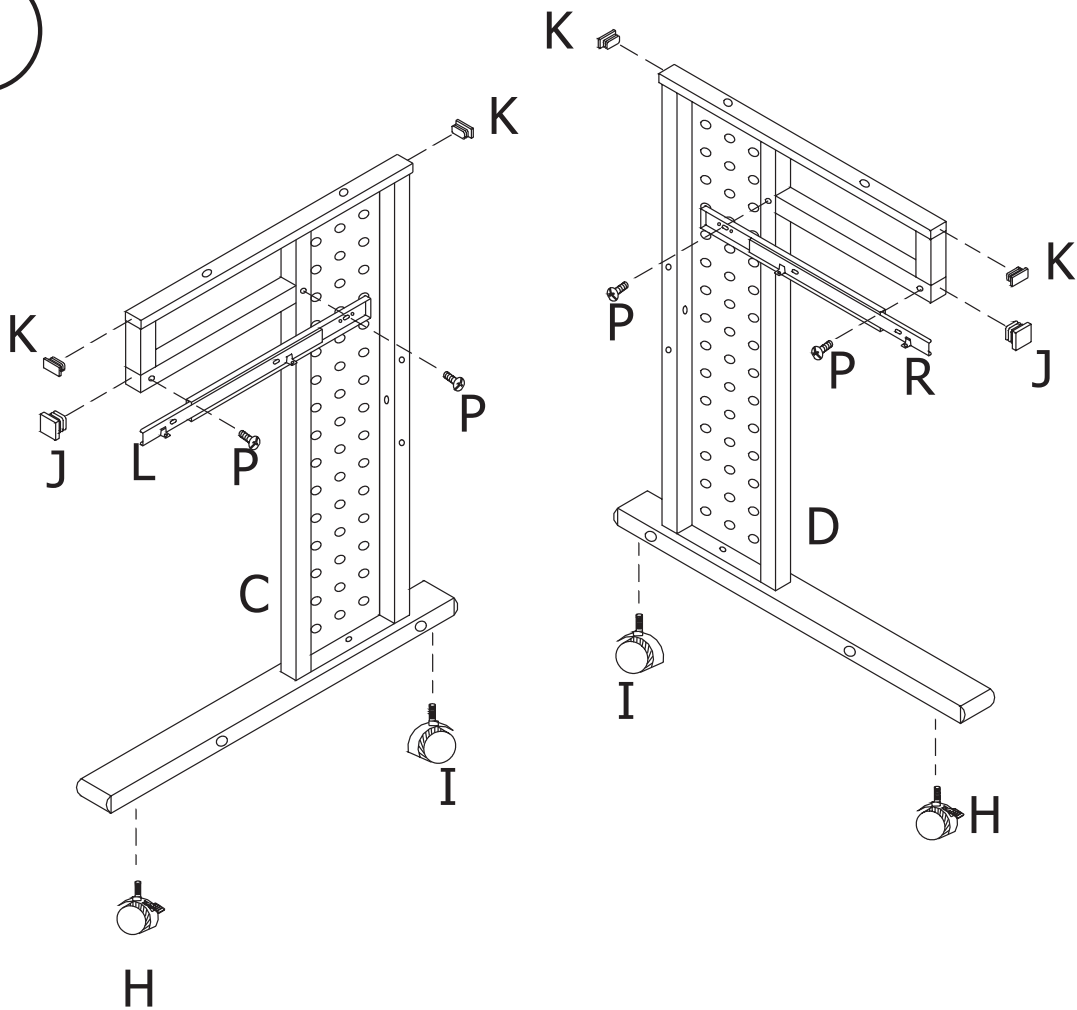

2

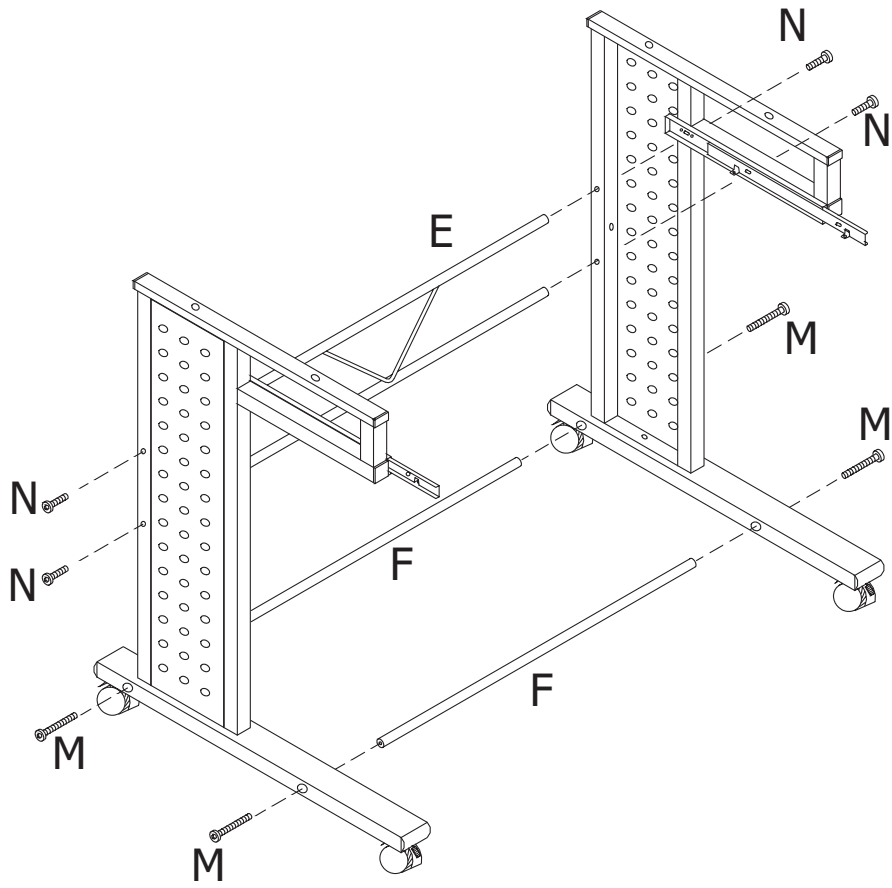

3

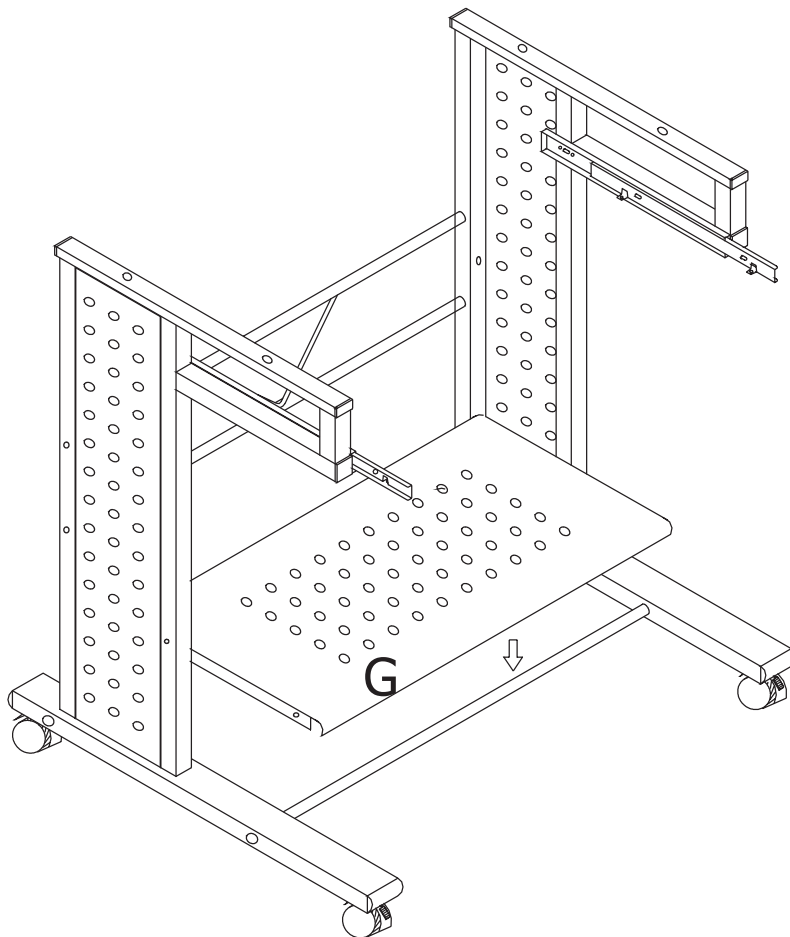

4

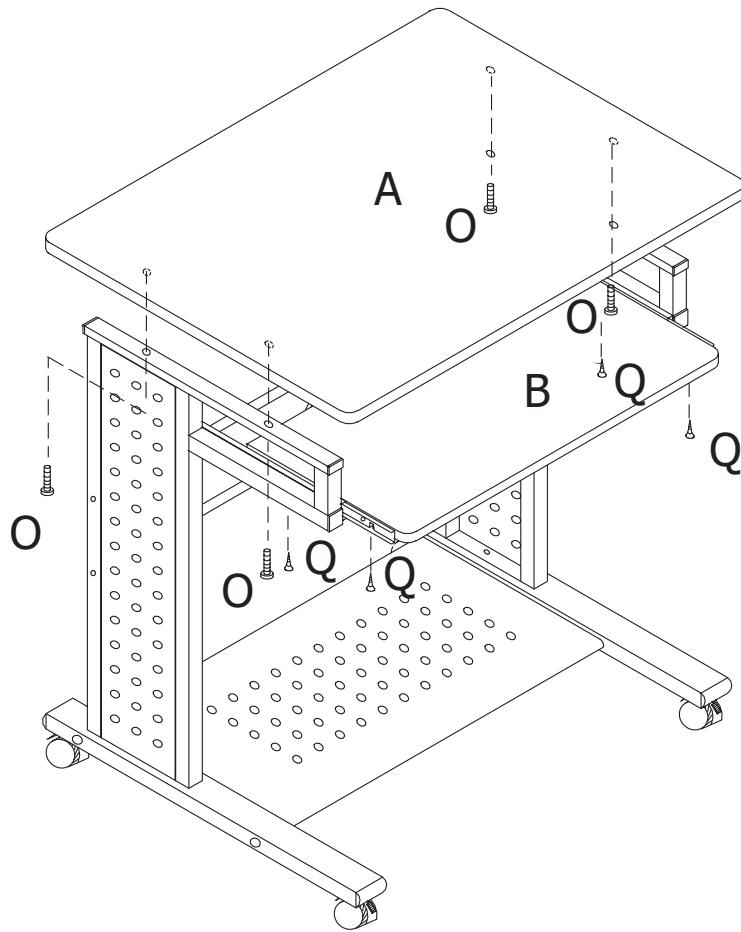

5

