



Programming reference guide

HP Engage Imaging Barcode Scanner II

© Copyright 2019 HP Development Company, L.P.

The information contained herein is subject to change without notice. The only warranties for HP products and services are set forth in the express warranty statements accompanying such products and services. Nothing herein should be construed as constituting an additional warranty. HP shall not be liable for technical or editorial errors or omissions contained herein.

Product notice

To access the latest user guides, go to <http://www.hp.com/support>, and follow the instructions to find your product.

Then select **User Guides**.

First Edition: December 2019

Document Part Number: L97610-001

Table of Contents

INTRODUCTION	1
About this Manual	1
Overview	1
Manual Conventions	2
About the Scanner	2
Using the Reader	2
Programming the Reader	3
Configuration Methods	3
SETUP.....	4
Unpacking	4
Setting Up the Scanner	4
Connect Host Interface	5
Stand Installation	7
Hands-Free Stand/Holder	7
Using the HP Engage Imaging Barcode Scanner II	8
Power Off	9
Interface Selection	10
Configuring the Interface	10
Customizing Configuration Settings	14
Using the Programming Bar Codes	14
Interface Settings	15
Configuring Other Features	15
Software Version Transmission	15
CONFIGURATION USING BAR CODES.....	16
Configuration Parameters	16
Global Interface Features	18
Host Commands — Obey/Ignore	18
USB Suspend Mode	18
RS-232 INTERFACE	19
RS-232 Standard Factory Settings	19

Baud Rate	19
Data Bits	21
Stop Bits	21
Parity	22
Handshaking Control	23
RS-232/USB-COM INTERFACES	25
Standard Factory Settings	25
Intercharacter Delay	26
Beep On ASCII BEL	27
Beep On Not on File	27
ACK NAK Options	29
ACK Character	29
NAK Character	29
ACK NAK Timeout Value	30
ACK NAK Retry Count	31
ACK NAK Error Handling	32
Indicate Transmission Failure	33
Disable Character	33
Enable Character	34
KEYBOARD INTERFACE	35
Country Mode	36
Setup on PC to use ALT Universal	36
Setting Country Mode	37
Setting Encoding Type	51
Setting ALT output type	58
Caps Lock State	59
Numlock	59
Keyboard Numeric Keypad	60
Keyboard Send Control Characters	61
Wedge Quiet Interval	62
Intercharacter Delay	63
Intercode Delay	64
USB Keyboard Speed	65
IBM 46XX INTERFACE	66
Interface Options	66
DATA FORMAT	67
Global Prefix/Suffix	68
Global AIM ID	69
GS1-128 AIM ID	69
Label ID	70
Label ID: Pre-loaded Sets	70
Label ID: Set Individually Per Symbology	71
Label ID Control	71
Label ID Symbology Selection	72
Case Conversion	77
Character Conversion	78
READING PARAMETERS	79
Double Read Timeout	81
Reading Performance	82
LED and Speaker Indicators	83
Power On Alert	83
Good Read: When to Indicate	84
Good Read Beep Type	85
Good Read Beep Frequency	85
Good Read Speaker Volume / Vibration	86
Silent Mode	87
Good Read Beep Length	88

Enable/Disable Good Read Indicator	89
Good Read LED Duration	90
Scanning Features	91
Scan Mode	91
Flash On Time	92
Flash Off Time	93
Object Detection Indication	94
Stand Mode/Object Detection Sensitivity	96
Stand Mode/Object Detection Illumination Off Time	97
Illumination Intensity and Frequency	97
Illuminator Refresh Frequency	98
Scanning Active Time	98
Motion Still Timeout	99
Pick Mode	100
Aiming Pointer	100
Aiming Duration Timer	101
Green Spot Duration	102
Mobile Phone Mode	103
Mobile Phone Saturation Rate	104
Decode Negative Image	105
Image Capture	105
Corded Stand Mode	106
Dock Detection Beep	107
Corded Stand Beep	107
Multiple Labels per Frame	108
Multiple Labels Ordering by Code Symbology	109
Multiple Labels Ordering by Code Length	109
1D SYMBOLOGIES	111
Introduction	111
Standard Factory Settings for Symbologies	111
Disable All Symbologies	112
Coupon Control	112
UPC-A	113
UPC-A Enable/Disable	113
UPC-A Check Character Transmission	113
Expand UPC-A to EAN-13	114
UPC-A Number System Character Transmission	114
UPC-E	116
UPC-E Enable/Disable	116
UPC-E Check Character Transmission	116
UPC-E 2D Component	117
Expand UPC-E to EAN-13	118
Expand UPC-E to UPC-A	118
UPC-E Number System Character Transmission	118
GTIN Formatting	119
EAN 13	120
EAN 13 Enable/Disable	120
EAN 13 Check Character Transmission	120
EAN-13 Flag 1 Character	121
EAN-13 ISBN Conversion	121
ISSN Enable/Disable	122
EAN 8	123
EAN 8 Enable/Disable	123
EAN 8 Check Character Transmission	123
Expand EAN 8 to EAN 13	124
UPC/EAN Global Settings	125
UPC/EAN Price Weight Check	125
UPC/EAN Quiet Zones	126
Add-Ons	126
Optional Add-ons	127

Optional Add-On Timer	128
Optional GS1-128 Add-On timer	129
GS1 DataBar™ Omnidirectional	131
GS1 DataBar Omnidirectional Enable/Disable	131
GS1 DataBar Omnidirectional GS1-128 Emulation	132
GS1 DataBar™ Omnidirectional 2D Component	132
GS1 DataBar™ Expanded	133
GS1 DataBar Expanded Enable/Disable	133
GS1 DataBar Expanded GS1-128 Emulation	133
GS1 DataBar Expanded 2D Component	134
GS1 DataBar Expanded Length Control	135
GS1 DataBar Expanded Set Length 1	135
GS1 DataBar Expanded Set Length 2	137
GS1 DataBar™ Limited	137
GS1 DataBar Limited Enable/Disable	137
GS1 DataBar Limited GS1-128 Emulation	139
GS1 DataBar Limited 2D Component	139
Code 39	139
Code 39 Enable/Disable	139
Code 39 Check Character Calculation	139
Code 39 Check Character Transmission	140
Code 39 Start/Stop Character Transmission	141
Code 39 Full ASCII	141
Code 39 Quiet Zones	142
Code 39 Length Control	143
Code 39 Set Length 1	144
Code 39 Set Length 2	145
Code 32 (Italian Pharmaceutical)	148
Code 32 Enable/Disable	148
Code 32 Feature Setting Exceptions	148
Code 32 Check Character Transmission	148
Code 32 Start/Stop Character Transmission	149
Code 39 CIP (French Pharmaceutical)	149
Code 39 CIP Enable/Disable	149
Code 128	150
Code 128 Enable/Disable	150
Expand Code 128 to Code 39	150
Code 128 Check Character Transmission	151
Code 128 Function Character Transmission	151
Code 128 Quiet Zones	152
Code 128 Length Control	153
Code 128 Set Length 1	153
Code 128 Set Length 2	154
GS1-128	155
GS1-128 Enable	155
Interleaved 2 of 5 (I 2 of 5)	156
I 2 of 5 Enable/Disable	156
I 2 of 5 Check Character Calculation	157
I 2 of 5 Check Character Transmission	158
I 2 of 5 Length Control	159
I 2 of 5 Set Length 1	159
I 2 of 5 Set Length 2	160
Interleaved 2 of 5 CIP HR	161
Interleaved 2 of 5 CIP HR Enable/Disable	161
Matrix 2 of 5	162
Matrix 2 of 5 Enable/Disable	162
Matrix 2 of 5 Check Character Calculation	162
Matrix 2 of 5 Check Character Transmission	163
Matrix 2 of 5 Length Control	163
Matrix 2 of 5 Set Length 1	164
Matrix 2 of 5 Set Length 2	165
Datalogic 2 of 5	166

Datalogic 2 of 5 Enable/Disable	166
Datalogic 2 of 5 Check Character Calculation	166
Datalogic 2 of 5 Check Character Transmission	167
Datalogic 2 of 5 Length Control	168
Datalogic 2 of 5 Set Length 1	168
Datalogic 2 of 5 Set Length 2	169
Compressed 2 of 5	170
Compressed 2 of 5 Enable/Disable	170
Compressed 2 of 5 Check Character Calculation	170
Compressed 2 of 5 Check Character Transmission	171
Compressed 2 of 5 Length Control	171
Compressed 2 of 5 Set Length 1	172
Compressed 2 of 5 Set Length 2	173
Codabar	174
Codabar Enable/Disable	174
Codabar Check Character Calculation	174
Codabar Check Character Transmission	174
Codabar Start/Stop Character Transmission	176
Codabar Start/Stop Character Set	177
Codabar Start/Stop Character Match	177
Codabar Quiet Zones	178
Codabar Length Control	179
Codabar Set Length 1	179
Codabar Set Length 2	180
ABC Codabar	181
ABC Codabar Enable/Disable	181
ABC Codabar Concatenation Mode	181
ABC Codabar Dynamic Concatenation Timeout	182
ABC Codabar Force Concatenation	182
Code 11	183
Code 11 Enable/Disable	183
Code 11 Check Character Calculation	183
Code 11 Check Character Transmission	184
Code 11 Length Control	184
Code 11 Set Length 1	185
Code 11 Set Length 2	186
Standard 2 of 5	187
Standard 2 of 5 Enable/Disable	187
Standard 2 of 5 Check Character Calculation	187
Standard 2 of 5 Check Character Transmission	188
Standard 2 of 5 Length Control	188
Standard 2 of 5 Set Length 1	189
Standard 2 of 5 Set Length 2	190
Industrial 2 of 5	191
Industrial 2 of 5 Enable/Disable	191
Industrial 2 of 5 Check Character Calculation	191
Industrial 2 of 5 Check Character Transmission	192
Industrial 2 of 5 Length Control	192
Industrial 2 of 5 Set Length 1	192
Industrial 2 of 5 Set Length 2	193
IATA	195
IATA Enable/Disable	195
IATA Check Character Transmission	195
ISBT 128	196
ISBT 128 Concatenation	196
ISBT 128 Concatenation Mode	196
ISBT 128 Dynamic Concatenation Timeout	197
ISBT 128 Force Concatenation	198
ISBT 128 Advanced Concatenation Options	198
MSI	199
MSI Enable/Disable	199
MSI Check Character Calculation	199

MSI Check Character Transmission	200
MSI Length Control	200
MSI Set Length 1	201
MSI Set Length 2	202
Plessey Enable/Disable	203
Plessey Check Character Calculation	204
Plessey Check Character Transmission	204
Plessey Length Control	205
Plessey Set Length 1	206
Plessey Set Length 2	207
Code 93	208
Code 93 Enable/Disable	208
Code 93 Check Character Calculation	208
Code 93 Check Character Transmission	209
Code 93 Length Control	209
Code 93 Set Length 1	209
Code 93 Set Length 2	209
Code 93 Quiet Zones	212
Follett 2 of 5	213
Follett 2 of 5 Enable/Disable	213
BC412	213
BC412 Enable/Disable	213
BC412 Check Character Calculation	214
BC412 Check Character Transmission	214
BC412 Length Control	215
BC412 Set Length 1	216
BC412 Set Length 2	217
2D SYMBOLOGIES	219
2D Global Features	219
2D Maximum Decoding Time	220
2D Structured Append	221
2D Normal/Inverse Symbol Control	221
SYMBOLOGY SELECTION	222
Aztec Code	222
Aztec Code Enable / Disable	222
Aztec Code Length Control	222
China Sensible Code	225
China Sensible Code Enable / Disable	225
China Sensible Code Length Control	225
Data Matrix	228
Data Matrix Enable / Disable	228
Data Matrix Square/Rectangular Style	228
Data Matrix Length Control	229
GS1 DotCode	231
DotCode Enable	231
DotCode High Resolution Enable	231
DotCode Position-based Decoding	232
Additional Options	232
Maxicode	232
Maxicode Enable / Disable	233
Maxicode Primary Message Transmission	233
Maxicode Length Control	234
PDF417	234
PDF417 Enable / Disable	234
PDF417 Length Control	234
Micro PDF417	239
Micro PDF417 Enable / Disable	239
Micro PDF417 Code 128 GS1-128 Emulation	239
Micro PDF417 Length Control	240
QR Code	242
QR Code Enable / Disable	242
QR Code Length Control	242

Micro QR Code	245
Micro QR Code Enable/Disable	245
Micro QR Code Length Control	245
UCC Composite	248
UCC Optional Composite Timer	248
Postal Code Selection	249
Postnet BB Control	250
OCR DECODING	251
OCR predefined template: EU ID Card OCR Format	251
OCR predefined template: IATA Passport	252
OCR predefined template: Italian Post payment form	252
OCR predefined template: Italian Bank payment form	252
OCR predefined template: Swiss Driving License	252
OCR Decoding Disable	253
REFERENCES.....	257
RS-232 Parameters	258
RS-232 Only	258
RS-232/USB COM Parameters	259
Keyboard Interface	266
Wedge Quiet Interval	266
Intercharacter Delay	267
Intercode Delay	268
Data Format	269
Data Editing	269
Global Prefix/Suffix	270
Global AIM ID	271
Label ID	272
Character Conversion	276
Scanning Features	277
Good Read LED Duration	277
RGB Good Read Color	278
Scan Mode	278
Scanning Active Time	280
Aiming Duration Time	281
Flash On Time	282
Flash Off Time	283
RF Features	284
Automatic Configuration Update	284
RF Address Stamping	284
Symbologies	286
Set Length	286
TECHNICAL SPECIFICATIONS.....	287
LED and Beeper Indications	288
Programming Mode	292
Troubleshooting	292
Standard Cable Pinouts	293
STANDARD DEFAULTS.....	295
Default Exceptions	303
SAMPLE BAR CODES	307
KEYPAD.....	311
SCANCODE TABLES.....	313
Control Character Emulation	313
Single Press and Release Keys	313
Interface Type PC AT PS/2 or USB-Keyboard	315
Interface Type PC AT PS/2 Alt Mode or USB-Keyboard Alt Mode	317
Microsoft Windows Codepage 1252	318

Chapter 1

Introduction

About this Manual

This Product Reference Guide (PRG) is provided for users seeking advanced technical information, including connection, programming, maintenance and specifications.

Typically, units are factory-programmed for the most common terminal and communications settings. If you need to modify any programmable settings, custom configuration can be accomplished by scanning the programming bar codes within this guide.

Programming can alternatively be performed using the HP Barcode Scanner D-Series Configuration Utility. This multi-platform utility program allows device configuration using a PC. It communicates to the device using a serial or USB cable and can also create configuration bar codes to print.

Overview

Chapter 1, [Introduction](#) provides a product overview, unpacking instructions, and cable connection information.

Chapter 2, [Setup](#) presents information about unpacking and setting up the scanner, and interface configuration bar codes and details.

Chapter 3, [Configuration Using Bar Codes](#) provides instructions and bar code labels for customizing your scanner. There are different sections for interface types, general features, data formatting, and symbology-specific features.

Chapter 4, [References](#) provides details concerning programmable features.

Appendix A, [Technical Specifications](#) lists physical and performance characteristics, as well as environmental and regulatory specifications. It also provides standard cable pin-outs and descriptions of the functions and behaviors of the scanner's LED and Speaker indicators.

Appendix B, [references common factory default settings for scanner features and options.](#)

Appendix C, [Sample Bar Codes](#) offers sample bar codes of several common symbologies.

Appendix D, [Keypad](#) includes numeric bar codes to be scanned for certain parameter settings.

Appendix E, [Scancode Tables](#) lists control character emulation information for Wedge and USB Keyboard interfaces.

Manual Conventions

The symbols listed below are used in this manual to notify the reader of key issues or procedures that must be observed when using the scanner:



NOTE

Notes contain information necessary for properly diagnosing, repairing and operating the scanner.



CAUTION

The CAUTION symbol advises you of actions that could damage equipment or property.

About the Scanner

With rich feature sets and extensive model options, the HP Engage Imaging Barcode Scanner II represents the premium level of data collection equipment for general purpose applications. The reader has enhanced Megapixel optics with improved motion tolerance, allowing codes placed on fast-moving objects to be easily and quickly captured, creating the ideal reader for tasks requiring high throughput like those found in retail, light industrial environments and healthcare.

Using the Reader

To read a symbol or capture an image, simply aim the reader and pull the trigger. The HP Engage Imaging Barcode Scanner II is a powerful omni-directional reader, so the orientation of the symbol is not important. 'Green Spot' for good-read feedback helps to improve productivity in noisy environments or in situations where silence is required. When positioning the product into the stand, the magnetic coupling will make the scanner automatically detect a bar code inside the field of view, and switch the reading system from trigger mode to autosense mode.

The HP Engage Imaging Barcode Scanner II reliably decodes all standard 1D (linear) and 2D bar codes, including GS1 DataBar™ linear codes, Postal Codes (China Post), Stacked Codes (such as GS1 DataBar Expanded Stacked, GS1 DataBar Stacked, GS1 DataBar, Stacked Omnidirectional). The data stream - acquired from decoding a symbol - is rapidly sent to the host. The reader is immediately available to read another symbol.

Figure 1. Correct positioning of scanner



A



B

Programming the Reader

Configuration Methods

Programming Bar Codes

The reader is factory-configured with a standard set of default features. After scanning the interface bar code, you can select other options and customize your reader through use of the instructions and programming bar code labels available in the corresponding features section for your interface. Customizable settings for many features are found in [Configuration Parameters](#).

Some programming labels require only the scan of the single label to enact the change. Most, however, require the reader to be placed in Programming Mode prior to scanning them. Scan an ENTER/EXIT bar code once to enter Programming Mode. Once the reader is in Programming Mode, scan a number of parameter settings before scanning the ENTER/EXIT bar code a second time, which will then accept your changes, exit Programming Mode and return the reader to normal operation.



There are some exceptions to the typical programming sequence described above. Please read the description and setting instructions carefully when configuring each programmable feature.

HP configuration utility

HP Barcode Scanner D-Series Configuration Utility is a multi-platform utility program providing a quick and user-friendly configuration method via the RS-232/USB-COM interface. The utility is available from the HP website. The utility allows you to program the reader by selecting configuration commands through a user-friendly graphical interface running on a PC. These commands are sent to the reader over the selected communication interface, or they can be printed as bar codes to be scanned.

The utility also provides the ability to perform a software upgrade for the connected device.

Chapter 2

Setup

Unpacking

Check carefully to ensure the scanner and any cables or accessories ordered are present and undamaged. If any damage occurred during shipment, contact Technical Support.

KEEP THE PACKAGING. Should the unit ever require service, it should be returned in its original shipping container.

Setting Up the Scanner

Follow the steps provided in this section to connect and get your scanner up and communicating with its host:

1. Connect the Interface Cable to the scanner or to the Base Station as shown in Figure 2. To disconnect the cable, insert a paper clip or similar object into the opening shown.
2. Connect the other end to the Host (see the next section, [Connect Host Interface](#) and Figure 3).
3. Modify [Customizing Configuration Settings](#) (only if modifications are needed from factory settings).

Connect Host Interface

The scanner kit you ordered to match your interface should provide a compatible cable for your installation. If this is not so, contact [Technical Support](#).

The scanner can communicate using the interfaces illustrated below.

For corded versions, connect the reader cable by inserting the cable into the handle as shown in the following Figure. To remove it, insert a paper clip into the release aperture, then unplug the cable.

Figure 2. Cable Connection/Disconnection at the Scanner

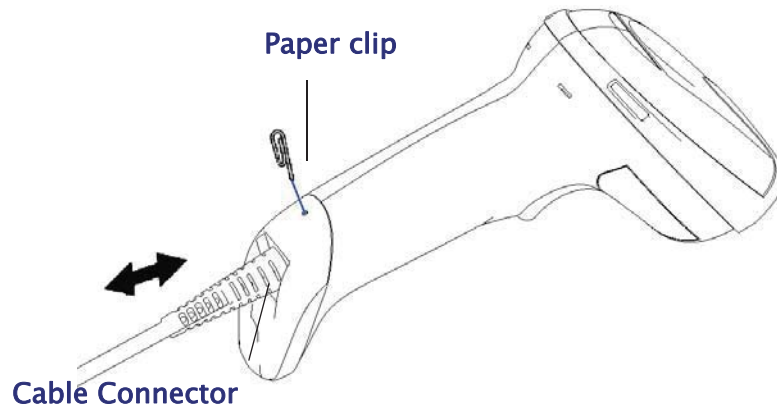

RS-232 Serial Connection

Turn off power to the terminal/PC and connect the scanner to the terminal/PC serial port via the RS-232 cable as shown in Figure 3. If the terminal will not support POT (Power Off the Terminal) to supply scanner power, use the approved power supply (AC Adapter). Plug the AC Adapter barrel connector into the socket on the RS-232 cable connector and the AC Adapter plug into a standard power outlet.

RS-232: The scanner can communicate with a standard or Wincor-Nixdorf (W-N) RS-232 host.

RS-232 OPOS: This interface is used for OPOS/UPOS/JavaPOS systems.

Keyboard Wedge Connection

The Keyboard Wedge cable has a 'Y' connection from the scanner. Connect the female to the male end from the keyboard and the remaining end at the keyboard port at the terminal/PC.

Keyboard Wedge (KBW): When connected using this interface, the host interprets scanned data as keystrokes and supports several international keyboards (for the Windows® environment). See "Country Mode" for a full listing.

USB Connection

Connect the scanner to a USB port on the terminal/PC using the correct USB cable for the interface type you ordered.

USB: Select to communicate either by USB COM STD or USB Keyboard interface types by scanning the appropriate interface type bar codes available in this manual. The default interface is USB-KBD, or RS-232-STD.

Figure 3. Connection to the Host

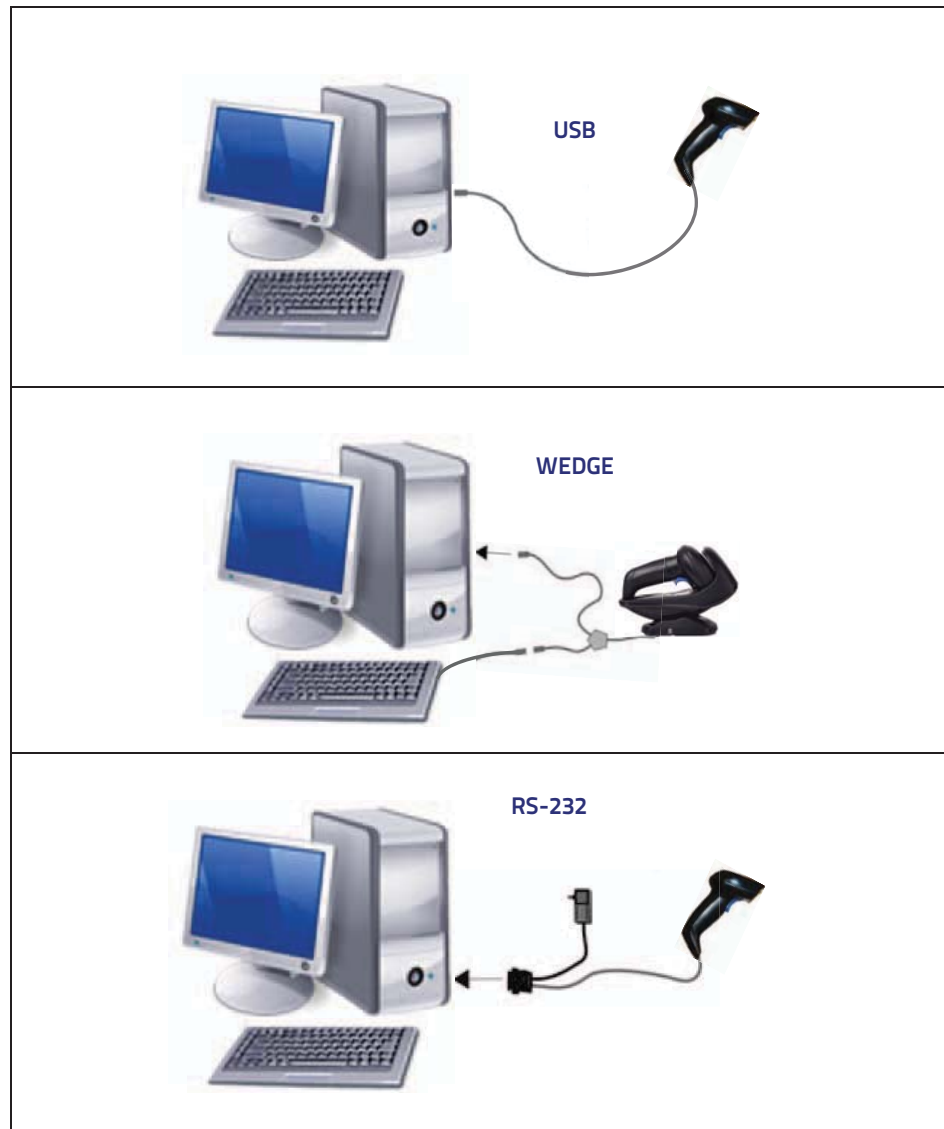
**NOTE**

Specific cables are required for connection to different hosts. The connections illustrated in Figure 3 are examples only. Actual connectors may vary from those illustrated, but the steps to connect the scanner remain the same.

Stand Installation

Hands-Free Stand/Holder

An accessory is available which holds the reader (except those with integrated stand) at a convenient angle, allowing hands free scanning of items.

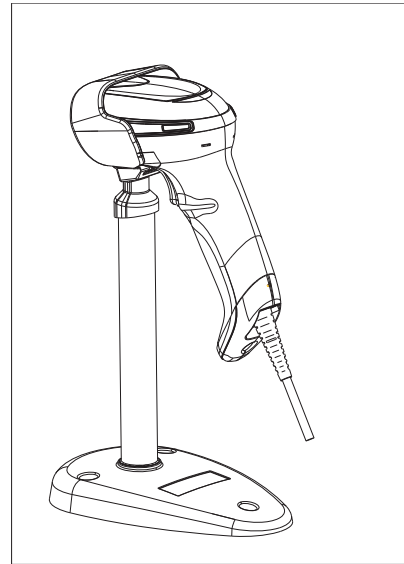
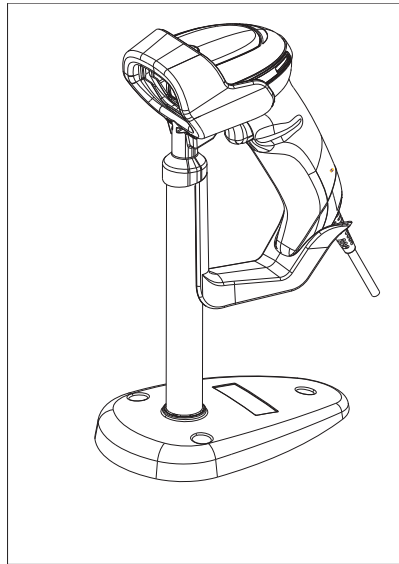

It can also be used as a holder. The holder “cup” can be positioned in any of the angles shown in the figure below. The Desk model automatically recognizes the insertion and changes its Scan Mode to allow the user to operate in hands-free mode.

Figure 4. Adjusting the Stand Arm

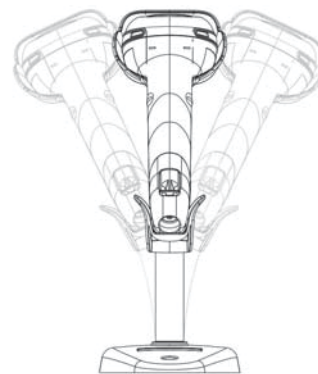
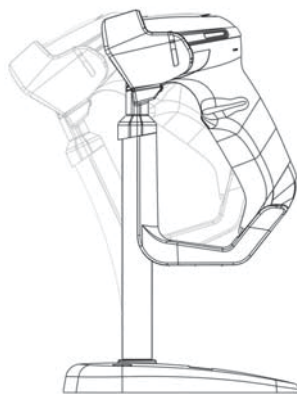

Using the HP Engage Imaging Barcode Scanner II

The HP Engage Imaging Barcode Scanner II normally functions by capturing and decoding codes. The aiming system is activated on trigger pull and indicates the center of the field of view which should be positioned over the bar code:

Aiming System



Relative Size and Location of Aiming System Pattern

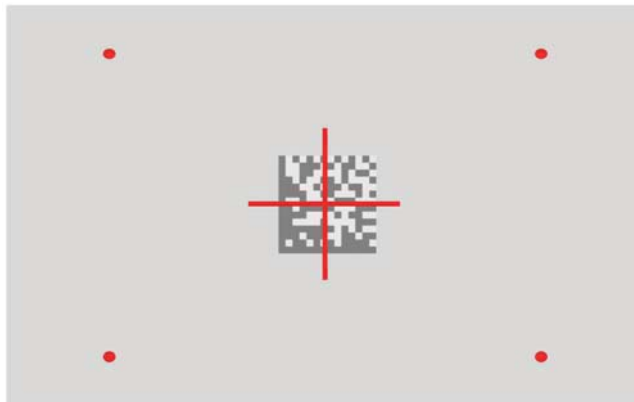

2D Matrix Symbol

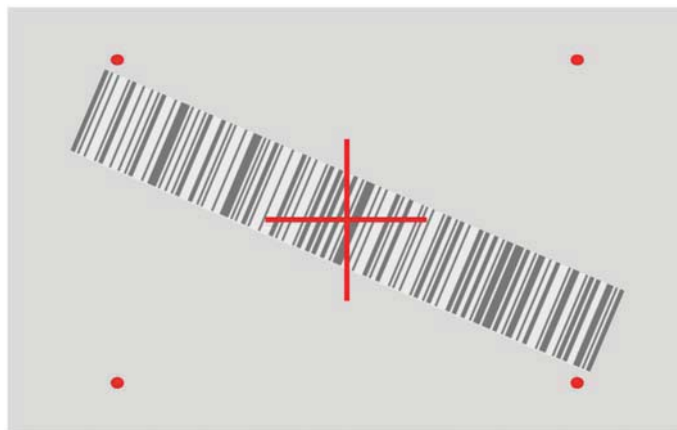

Linear Bar

A red beam illuminates the label. The field of view indicated by the aiming system will be smaller when the reader is closer to the bar code and larger when it is farther from the code. Symbologies with smaller bars or elements (mil size) should be read closer to the unit. Symbologies with larger bars or elements (mil size) should be read farther from the unit. If the aiming system is centered and the entire bar code is within the aiming field, you will get a good read. Successful reading is signaled by an audible tone plus a good-read green spot LED indicator.

Relative Size and Location of Green Spot

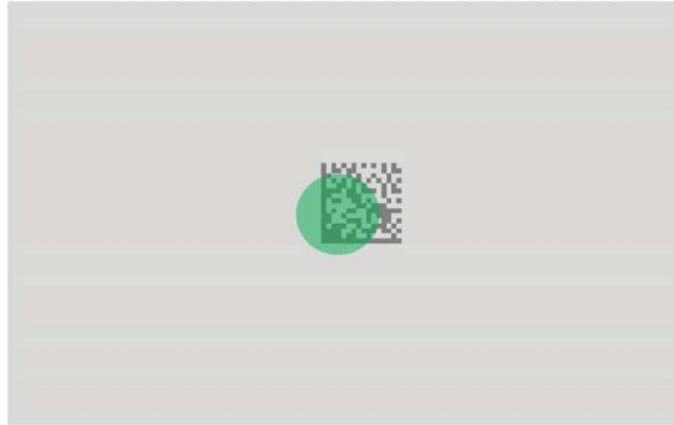

Power Off

Scan the bar code below to shut off power to the handheld until the next trigger pull.



PowerOff

Interface Selection

Upon completing the physical connection between the scanner and its host, proceed directly to "Configuring the Interface" for information and programming for the interface type the scanner is connected to (for example: RS-232, Keyboard Wedge, USB, etc.) and scan the appropriate bar code in that section to select your system's correct interface type.

The scanner, depending upon the model, will support one of the following sets of host interfaces:

- USB (Keyboard, COM)
- USB Composite (Keyboard + COM)
- USB HID POS
- USB Toshiba TEC
- RS-232 STD
- RS-232 WN
- RS232 OPOS
- Keyboard Wedge
- IBM46XX port 9b (a specific cable's required)
- Datalogic Magellan Scanners' specific interface

Configuring the Interface





Scan the programming bar code from the following section which selects the appropriate interface type to match the system the scanner will be connected to. Next, proceed to the corresponding chapter in this manual (also listed in the table) to configure any desired settings and features associated with that interface.



NOTE

Unlike some other programming features and options, interface selections require that you scan only one programming bar code label. **DO NOT** scan an ENTER/EXIT bar code prior to scanning an interface selection bar code. Some interfaces require the scanner to start in the disabled state when powered up. If additional scanner configuration is desired while in this state, pull the trigger and hold for 5 seconds. The scanner will change to a state that allows programming with bar codes.

Table 3. Available Interfaces

RS-232	FEATURES
<p>RS-232 standard interface</p> <p><i>*Not supported on USB only models</i></p>  <p>Select RS232-STD</p>	
 <p>Select RS232-WN</p> <p>RS-232 Wincor-Nixdorf</p>	
<p>RS-232 for use with OPOS/UPOS/JavaPOS</p>  <p>Select RS-232 OPOS</p>	
 <p>Select USB-COM-STD</p> <p>USB COM to simulate RS-232 standard interface</p> <p><i>*USB COM driver need to be installed for this interface to work.</i></p>	

- a. If erroneously read, it is required to press and hold the trigger to unlock the reader. Then read the correct interface bar code. This will work only at power-up. Please reconnect the scanner if the unlock is not successful.

USB-COMPOSITE	FEATURES
<p>USB-Composite (combines USB-KBD emulation and USB-COM)</p> <p><i>*USB COM driver need to be installed for this interface to work.</i></p>	
<p>OTHER INTERFACES</p>	
<p></p> <p>Select IBM46xx Port 9b</p>	<p>IBM46xx Port 9b</p>
<p>USB HID POS</p>	<p></p> <p>Select USB HID POS</p>
<p></p> <p>Select USB Toshiba TEC</p>	<p>USB Toshiba TEC</p>
<p>Datalogic Magellan Scanners' specific interface, USB AUX</p>	<p></p> <p>Select Datalogic Magellan Scanners' specific interface, USB AUX</p>
<p></p> <p>Magellan RS232 AUX port</p>	<p>Datalogic Magellan RS232 AUX port</p>

KEYBOARD	FEATURES
<p>AT, PS/2 25-286, 30-286, 50, 50Z, 60, 70, 80, 90 & 95 w/Standard Key Encoding</p>  <p>Select KBD-AT</p>	Set KEYBOARD WEDGE Interface Features
 <p>Select KBD-AT-NK</p> <p>Keyboard Wedge for IBM AT PS2 with standard key encoding but without external keyboard</p>	
<p>AT, PS/2 25-286, 30-286, 50, 50Z, 60, 70, 80, 90 & 95 w/Alternate Key</p>  <p>Select KBD-AT-ALT</p>	
 <p>Select KBD-AT-ALT-NK</p> <p>Keyboard Wedge for IBM AT PS2 with alternate key encoding but without external keyboard</p>	
<p>USB Keyboard with standard key encoding</p>  <p>Select USB Keyboard</p>	
 <p>Select USB Alternate Keyboard</p> <p>USB Keyboard with alternate key encoding</p>	

Customizing Configuration Settings

Using the Programming Bar Codes

This manual contains feature descriptions and bar codes which allow you to reconfigure your scanner. Some programming bar code labels, like [Resetting the Product Configuration to Defaults](#), require only the scan of that single label to enact the change. Most of the programming labels in this manual, however, require the scanner to be placed in Programming Mode prior to scanning them. Scan an ENTER/EXIT bar code once to enter Programming Mode. Once the scanner is in Programming Mode, you can scan a number of parameter settings before scanning the ENTER/EXIT bar code a second time, which will then accept your changes, exit Programming Mode and return the scanner to normal operation.



NOTE

There are some exceptions to the typical programming sequence described above. Please read the description and setting instructions carefully when configuring each given programmable feature.

HP configuration utility

Programming can alternatively be performed using the HP Barcode Scanner D-Series Configuration Utility which is available for free download from www.hp.com. This multi-platform utility program allows device configuration using a PC. It communicates to the device using a serial or USB cable and can also create configuration bar codes to print.

HP Barcode Scanner D-Series Configuration Utility is a multi-platform utility program providing a quick and user-friendly configuration method via the RS-232/USB-COM interface. The utility allows you to program the scanner by selecting configuration commands through a user-friendly graphical interface running on a PC. These commands are sent to the scanner over the selected communication interface, or they can be printed as bar codes to be scanned.

The utility also provides the ability to perform a software upgrade for the connected device.

Interface Settings

The scanner is typically factory-configured with a set of default features standard to the interface type you ordered. See "Interface Selection".

Global Interface Features provides settings configurable by all interface types. If your installation requires you to further customize your scanner, you can select other options through use of the instructions and programming bar codes available in the appropriate section for your interface.

- RS-232 INTERFACE
- RS-232/USB-COM INTERFACES
- RS232 OPOS
- **USB Composite (COM + Keyboard)**
- KEYBOARD INTERFACE

Configuring Other Features

If your installation requires different programming than the standard factory default settings, the following sections of this manual allow configuration of non-interface-specific settings you might require:

Configuration Using Bar Codes: General Features includes programming for scanning, speaker and LED indicators and other such universal settings.

Reading Parameters: Reading Parameters include programming for scanning, speaker and LED indicators and other universal settings.

1D Symbologies: Includes options concerning the bar code label types (symbologies). These settings allow you to enable/disable symbologies, set label lengths, require check digit, etc.

Software Version Transmission

The software version of the device can be transmitted over the RS-232, Keyboard and USB interfaces by scanning the following label.



Transmit Software Version

Resetting the Product Configuration to Defaults

If you aren't sure what programming options are in your scanner, or you've changed some options and want to restore the Custom Default Configuration that may have been saved in the scanner, scan the Restore Custom Default Configuration bar code below. This will restore the custom configuration for the currently active interface.



NOTE

Custom defaults are based on the interface type. Configure the scanner for the correct interface before scanning this label.



Restore Custom Default Configuration

Chapter 3

Configuration Using Bar Codes

This and following sections provide programming bar codes to configure your scanner by changing the default settings. For details about additional methods of programming, see "Customizing Configuration Settings".



NOTE

You must first enable your scanner to read bar codes in order to use this section. If you have not done this go to Setup and complete the appropriate procedure.

Configuration Parameters

Once the scanner is set up, you can change the default parameters to meet your application needs. Refer to "Resetting the Product Configuration to Defaults" for initial configuration in order to set the default values and select the interface for your application.

The following configuration parameters are divided into logical groups, making it easy to find the desired function based on its reference group.

Interface Configuration:

- RS-232 Interface
- RS-232/USB-COM Interfaces
- Keyboard Interface

Parameters common to all interface applications:

- Global Prefix/Suffix
- Data Format offers advanced configuration options for customization of scanned data output.
- Reading Parameters control various operating modes and indicators status functioning.

Symbology-specific parameters:

1D Symbologies defines options for all symbologies and provides the programming bar codes necessary for configuring these features.



NOTE

You must first enable your scanner to read bar codes in order to use this section. If you have not done this go to Setup and complete the appropriate procedure.



To program features:

1. Scan the ENTER/EXIT PROGRAMMING bar code, available at the top of each programming page, when applicable.
2. Scan the bar code to set the desired programming feature. You may need to cover unused bar codes on the page, and possibly the facing page, to ensure that the scanner reads only the bar code you intend to scan.
3. If additional input parameters are needed, go to [Appendix D, Keypad](#), and scan the appropriate characters from the keypad.



NOTE

Additional information about many features can be found in the "References" chapter.

If you make a mistake before the last character, scan the CANCEL bar code to abort and not save the entry string. You can then start again at the beginning.

4. Complete the programming sequence by scanning the ENTER/EXIT PROGRAMMING bar code to exit Programming Mode.

For more detailed descriptions, programming information and examples for setting selected configuration items, see [References](#).



Global Interface Features

The following interface features are configurable by all interface types. To set features specific to your interface, turn to that section of this manual.

HOST COMMANDS — OBEY/IGNORE
USB SUSPEND MODE

Host Commands — Obey/Ignore

This option specifies whether the scanner will obey or ignore host commands. When set to ignore, the scanner will ignore all host commands except for those necessary for:

- service mode
- flash programming mode
- keeping the interface active
- transmission of labels.

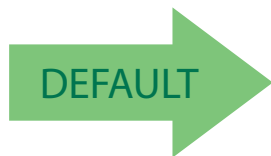

Host Commands = Obey



Host Commands = Ignore

USB Suspend Mode

This setting enables/disables the ability of the USB interface to enter suspend mode.



USB Suspend Mode = Disable



USB Suspend Mode = Enable





RS-232 Interface

Use the programming bar codes in this chapter if modifications to the standard RS-232 interface settings are necessary to meet your system’s requirements. Additional settings which apply to both the RS-232 and USB interfaces are available "RS-232/USB-COM Interfaces."

BAUD RATE	PARITY
DATA BITS	HANDSHAKING CONTROL

RS-232 Standard Factory Settings

Reference Appendix B, for a listing of standard factory settings.

Baud Rate

Baud rate is the number of bits of data transmitted per second. Set the scanner's baud rate to match the baud rate setting of the host device. With an improper baud rate setting, data may not reach the host correctly.



Baud Rate = 1200



Baud Rate = 2400



Baud Rate = 4800



Baud Rate = 9600





Baud Rate (continued)



Baud Rate = 19,200



Baud Rate = 38,400



Baud Rate = 57,600



Baud Rate = 115,200

Data Bits

This parameter allows the reader to interface with devices requiring a 7-bit or 8-bit ASCII protocol for sending and receiving data.

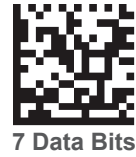

Handheld and Cradle models support the 8-bit ASCII protocol. The 7-bit ASCII protocol support is subject to specific firmware release. If the setting is not supported, the scanner will emit three short beeps upon scanning the label.

Stop Bits

The stop bit(s) at the end of each transmitted character marks the end of transmission of one character and prepares the receiving device for the next character in the serial data stream. The number of stop bits selected (one or two) depends on the number the receiving terminal is programmed to accommodate. Set the number of stop bits to match host device requirements.





Parity

This feature specifies parity required for sending and receiving data. A parity check bit is the most significant bit of each ASCII coded character. Select the parity type according to host device requirements.

- Select None when no parity bit is required.
- Select Odd parity and the parity bit value is set to 0 or 1, based on data, to ensure that an odd number of 1 bits are contained in the coded character.
- Select Even parity and the parity bit value is set to 0 or 1, based on data, to ensure that an even number of 1 bits are contained in the coded character.

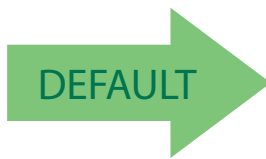

Parity = None



Parity = Even



Parity = Odd



Handshaking Control

The data interface consists of an RS-232 port designed to operate either with or without the hardware handshaking lines, Request to Send (RTS), and Clear to Send (CTS). Handshaking Control includes the following options:

- RTS — RTS is asserted during transmissions. CTS is ignored.
- RTS/CTS — RTS is asserted during transmissions. CTS gates transmissions.
- RTS/XON/XOFF — RTS is asserted during transmissions. CTS is ignored. XON and XOFF gate transmissions.
- RTS On/CTS — RTS is always asserted. CTS gates transmissions.
- RTS/CTS Scan Control — RTS is asserted during transmissions. CTS gates transmissions and controls enable and disable state of scanner.

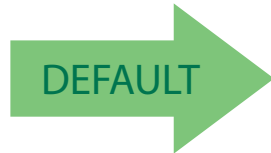

Handshaking Control = RTS



Handshaking Control = RTS/CTS



Handshaking Control = RTS/XON/XOFF



Handshaking Control = RTS On/CTS



Enter/Exit Programming Mode

Handshaking Control



Handshaking Control = RTS/CTS Scan Control



Handshaking Control = RTS Off

RS-232/USB-COM Interfaces

The programming bar codes in this chapter allow modifications to the standard RS-232 and USB-Com interfaces.

STANDARD FACTORY SETTINGS
INTERCHARACTER DELAY
BEEP ON ASCII BEL
BEEP ON NOT ON FILE
ACK NAK OPTIONS
ACK CHARACTER
NAK CHARACTER
ACK NAK TIMEOUT VALUE
ACK NAK RETRY COUNT
ACK NAK ERROR HANDLING
INDICATE TRANSMISSION FAILURE
DISABLE CHARACTER
ENABLE CHARACTER

Standard Factory Settings

Reference Appendix B, for a listing of standard factory settings.



Intercharacter Delay

This parameter specifies the intercharacter delay between the end of one character and the beginning of the next. The delay can be set within a range of zero (0) to 990 milliseconds in 10ms increments. A setting of zero specifies no delay. See "Label ID: Pre-loaded Sets" for more detailed program-ming instructions.



Intercharacter Delay = No Delay



Select Intercharacter Delay Setting

To configure this feature, scan the ENTER/EXIT bar code above, then the bar code at left followed by digits from the Alphanumeric characters in [Appendix D, Keypad](#) representing your desired character(s). End by scanning the ENTER/EXIT bar code again.

Make a mistake? Scan the CANCEL bar code to abort and not save the entry string. You can then start again at the beginning.



CANCEL

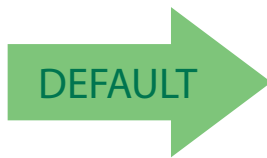

00 = No Intercharacter Delay

Beep On ASCII BEL

When this parameter is enabled, the scanner issues a beep when a <BEL> character is detected on the RS-232 serial line. <BEL> is issued to gain a user's attention to an illegal entry or other important event.



Beep On Not on File

This option enables/disables the action of the scanner to sound a three beep sequence upon receiving a Not-On-File (NOF) host command.

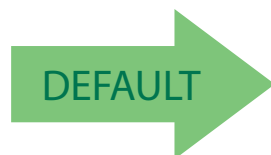



ACK NAK Options

This enables/disables the ability of the scanner to support the RS-232 ACK/NAK protocol. When configured, the scanner and/or host sends an “ACK” when it receives data properly, and sends “NAK” when the data is in error.

Options are:

- Disable
- Enable for label transmission — The scanner expects an ACK/NAK response from the host when a label is sent.
- Enable for host-command acknowledge — The scanner will respond with ACK/NAK when the host sends a command.
- Enable for label transmission and host-command acknowledge

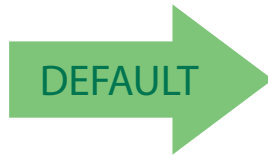

ACK/NAK Protocol = Disable ACK/NAK



ACK/NAK Protocol = Enable for label transmission



ACK/NAK Protocol = Enable for host-command acknowledge



ACK/NAK Protocol = Enable for label transmission and host-command acknowledge



ACK Character

This setting specifies an ASCII character or hex value to be used as the ACK character. ASCII characters or any hex value from 0 to 0xFF can be selected. See "ACK Character" for more detailed programming instructions.



Setting to previously defined characters such as XON, XOFF, or host commands conflicts with normal operation of these characters. 8-bit data is not recognized when the option Data Bits has been set as 7 Data Bits.

NOTE



Select ACK Character Setting

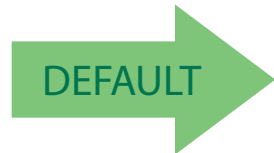

0x06 'ACK' Character

Make a mistake? Scan the CANCEL bar code to abort and not save the entry string. You can then start again at the beginning.



CANCEL

NAK Character

This setting specifies an ASCII character or hex value to be used as the NAK character. ASCII characters or any hex value from 0 to 0xFF can be selected. See "NAK Character" for more detailed programming instructions.



Setting to previously defined characters such as XON, XOFF, or host commands conflicts with normal operation of these characters. 8-bit data is not recognized when the option Data Bits has been set as 7 Data Bits.

NOTE



Select NAK Character Setting

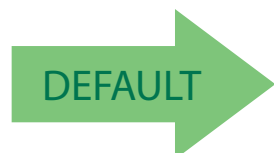

0x15 'NAK' Character



Make a mistake? Scan the CANCEL bar code to abort and not save the entry string. You can then start again at the beginning.



ACK NAK Timeout Value

This option specifies the amount of time the scanner waits for an ACK character from the host following label transmission. The selectable timeout range is 200 milliseconds to 15,000ms (15 seconds) in 200ms increments. A selection of 0 disables the timeout. See "ACK NAK Timeout Value" for more detailed programming instructions.



Select ACK NAK Timeout Value Setting

To configure this feature, scan the ENTER/EXIT bar code above, then the bar code at left followed by digits from the Alphanumeric characters in **Appendix D, Keypad** representing your desired character(s). End by scanning the ENTER/EXIT bar code again.

Make a mistake? Scan the CANCEL bar code to abort and not save the entry string. You can then start again at the beginning.

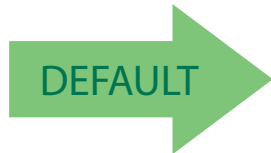

01 ACK NAK Timeout value is 200ms

ACK NAK Retry Count

This feature specifies the number of times the scanner retries a label transmission due to a retry condition. The selectable range is from 1 to 254 retries. A selection of 0 disables the count, and a selection of 255 specifies unlimited retries. See "ACK NAK Retry Count" for more detailed program-ming instructions.



Select ACK NAK Retry Count Setting

To configure this feature, scan the ENTER/EXIT bar code above, then the bar code at left followed by digits from the Alphanumeric characters in [Appendix D, Keypad](#) representing your desired character(s). End by scanning the ENTER/EXIT bar code again.

Make a mistake? Scan the CANCEL bar code to abort and not save the entry string. You can then start again at the beginning.



CANCEL





ACK NAK Error Handling

This feature specifies the method the scanner uses to handle receive errors detected while waiting for an ACK character from the host.

Options are:

- Ignore errors detected
- Process error as valid ACK character
- Process error as valid NAK character

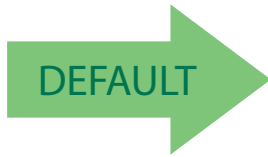

ACK NAK Error Handling = Ignore Errors Detected



ACK NAK Error Handling = Process Error
as Valid ACK Character



ACK NAK Error Handling = Process Error
as Valid NAK Character



Indicate Transmission Failure

This option enables/disables the scanner's ability to sound an error beep to indicate a transmission failure while in ACK/NAK mode.



Indicate Transmission Failure = Disable Indication



Indicate Transmission Failure = Enable Indication



Disable Character

Specifies the value of the RS-232 host command used to disable the scanner. ASCII characters or any hex value from 0 to 0xFF can be selected. See "Disable Character" for more detailed programming instructions.



NOTE

Setting to previously defined characters such as XON, XOFF, or host commands conflicts with normal operation of these characters.



Select Disable Character Setting



0x44 = Disable Character is 'D'

Make a mistake? Scan the CANCEL bar code to abort and not save the entry string. You can then start again at the beginning.



CANCEL



Enable Character

Specifies the value of the RS-232 host command used to enable the scanner. ASCII characters or any hex value from 0 to 0xFF can be selected. See "Enable Character" for more detailed programming instructions.



NOTE

Setting to previously defined characters such as XON, XOFF, or host commands conflicts with normal operation of these characters.



Select Enable Character Setting

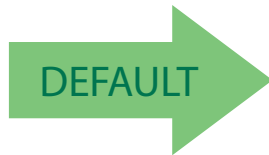

0x45 = Enable Character is 'E'

Make a mistake? Scan the CANCEL bar code to abort and not save the entry string. You can then start again at the beginning.



CANCEL

Keyboard Interface

Use the programming bar codes in this chapter to select options for USB Keyboard and Wedge Interfaces. Reference [Appendix B](#), for a listing of standard factory settings. Information about control character emulation which applies to keyboard interfaces is listed in [Appendix E, Scancode Tables](#).

COUNTRY MODE
CAPS LOCK STATE
NUMLOCK
KEYBOARD NUMERIC KEYPAD
KEYBOARD SEND CONTROL CHARACTERS
WEDGE QUIET INTERVAL
INTERCODE DELAY
USB KEYBOARD SPEED



Country Mode

This feature specifies the country/language supported by the keyboard. The Country Mode setting is ignored if the interface uses alternate key encoding.

Setup on PC to use ALT Universal

1. Open Registry Edit

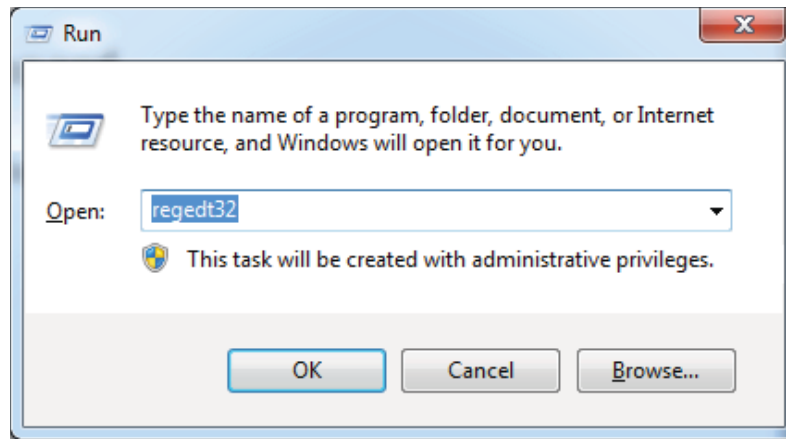

2. Set EnableHexNumpad to 1 as follows:

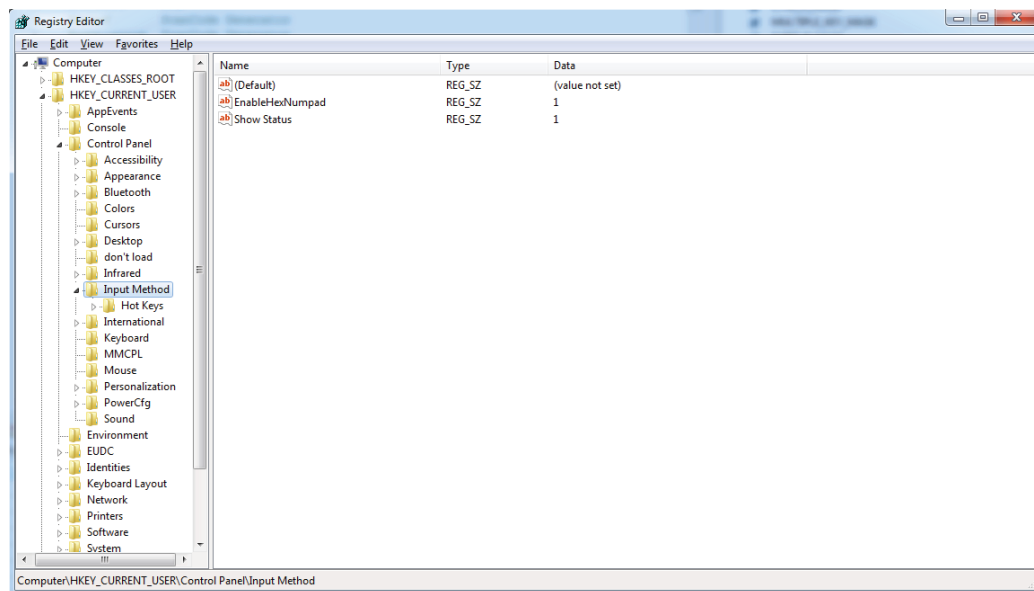

3. Reset the PC.



Setting Country Mode

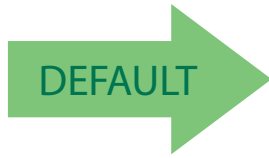

United States



French International (Belgian French)



United Kingdom



Danish



French (France)



German



Italian



Setting Country Mode (continued)



Norwegian



Portuguese Portugal



Spanish



Swedish



Swiss French



Japanese ASCII



Hungarian

Setting Country Mode (continued)



Slovak



Czech



Romanian



Croatian



Polish_214



Canadian French Win7



Lithuanian



Setting Country Mode (continued)



Vietnamese



Russian



Arabic 101



Chinese ASCII



Thai-Kedmanee



Albanian



Arabic 102



Setting Country Mode (continued)



Arabic 102 AZERTY



Azeri Cyrillic



Azeri Latin



Belarusian



Bosnian Cyrillic



Bosnian Latin



Bulgarian Cyrillic



Setting Country Mode (continued)



Bulgarian Latin



Canadian French (Legacy)



Canadian Multilingual



Chinese (Simplified)



Chinese (Traditional)



Czech Programmers



Czech QWERTY



Setting Country Mode (continued)



Dutch Netherland



Estonian



Faeroese



Finnish



French (Canada) 2000/XP



French (Canada) 95/98



Galician



Setting Country Mode (continued)



Greek



Greek Latin



Greek Polytonic



Greek220



Greek220 Latin



Greek319



Greek319 Latin

Setting Country Mode (continued)

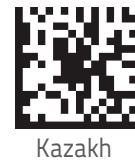
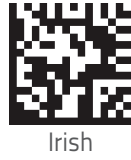



Setting Country Mode (continued)



Korean (Hangul)



Korean ASCII



Kyrgyz Cyrillic



Latin America



Latvian



Latvian QWERTY



Lithuanian_IBM



Setting Country Mode (continued)



Macedonian -FYROM



Maltese_47KEY



Mongolian-Cyrillic



Polish Programmer



Portuguese Brazil



Portuguese Brazilian ABNT



Portuguese Brazilian ABNT2



Setting Country Mode (continued)



Romanian Legacy



Romanian Programmer



Romanian Standard



Russian Typewriter



Serbian Cyrillic



Serbian Latin



Slovak QWERTY

Setting Country Mode (continued)





Setting Country Mode (continued)



US Dvorak



US Dvorak Left Hand



US Dvorak Right Hand



US English (Mac)



US English (North American)



US International



Uzbek Cyrillic

Setting Encoding Type

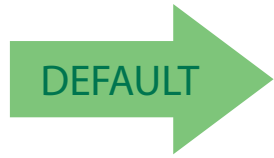

Don't use encoding



UTF_8



Windows 874



Windows 932



Windows 936



Windows 949



Windows 950



Setting Encoding Type (continued)



Windows 1250



Windows 1251



Windows 1252



Windows 1253



Windows 1254



Windows 1255



Windows 1256



Setting Encoding Type (continued)



Windows 1257



Windows 1258



Windows 20866



0x31 = Windows 54936



ISO 8859-1



ISO 8859-2



Setting Encoding Type (continued)



ISO 8859-3



ISO 8859-4



ISO 8859-5



ISO 8859-6



ISO 8859-7



ISO 8859-8



ISO 8859-9



Setting Encoding Type (continued)



ISO 8859-10



ISO 8859-11



ISO 8859-13



ISO 8859-14



ISO 8859-15



ISO 8859-16



MS-DOS 437



Setting Encoding Type (continued)



MS-DOS 737



MS-DOS 775



MS-DOS 850



MS-DOS 852



MS-DOS 855



MS-DOS 857



MS-DOS 860



Setting Encoding Type (continued)



MS-DOS 861



MS-DOS 862



MS-DOS 863



MS-DOS 865



MS-DOS 866



MS-DOS 869



Mac CP10000



Setting ALT output type

This option specifies the encode type of ALT Mode when the scanner sends Output Keyboard Data in Alt Mode. (Be aware that the scanner may switch automatically between ALT mode & Normal Keyboard Scancode, to correctly display some characters that are not present in the current Keyboard Country).

.



ALT Codepage: (use on non Unicode application: Notepad)



ALT Unicode: (use on Unicode application: Word)



ALT Universal: (Use for all)

Caps Lock State

This option specifies the format in which the scanner sends character data. This applies to Keyboard Wedge interfaces. This does not apply when an alternate key encoding keyboard is selected. This does not apply to USB Keyboard.

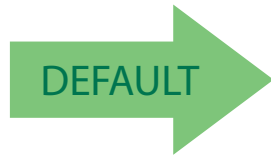

Caps Lock State = Caps Lock OFF



Caps Lock State = Caps Lock ON



Caps Lock State = AUTO Caps Lock Enable

Numlock

This option specifies the setting of the Numbers Lock (Numlock) key while in Keyboard Wedge interface. This only applies to alternate key encoding interfaces. It does not apply to USB Keyboard.

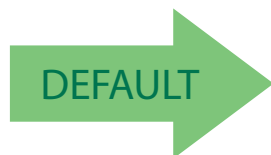

Numlock = Numlock key unchanged



Numlock = Numlock key toggled



Keyboard Numeric Keypad

This feature specifies if numeric characters will be sent using the standard keys or the numeric keypad.

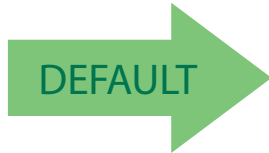

Keyboard Numeric Keypad = Standard Keys



Keyboard Numeric Keypad = Numeric Keypad

Keyboard Send Control Characters

This feature is used by the Keyboard Wedge and USB Keyboard interfaces. It specifies how the scanner transmits ASCII control characters to the host. Reference [Appendix E, Scancode Tables](#) for more information about control characters.

Options are as follows:

Send Ctrl+Key : ASCII characters from 00H to 0x1FH inclusive are transmitted in the format Ctrl+Key. Special keys are available in the range from 81H to A1.

Send Ctrl+Shift+Key : The behavior is the same as above, but control keys are sent in the format Ctrl+Shift+Keys.

Send Special Function Key : Send characters between 00H and 1FH according to the special function key mapping table (see "[Interface Type PC AT PS/2 Alt Mode or USB-Keyboard Alt Mode](#)"). This is used to send keys that are not in the normal ASCII set. A unique set is provided for each available scancode set.

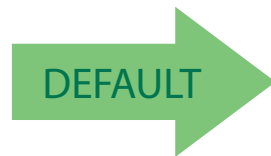

Keyboard Send Control Characters = Send Ctrl+Key



Keyboard Send Control Characters = Send Ctrl+Shift+Key



Keyboard Send Control Characters = Send Special Function Key :



Wedge Quiet Interval

This option specifies the amount of time to look for keyboard activity before the scanner breaks the keyboard connection in order to transmit data to host. The selectable range for this feature is from 0 to 990ms in 10ms increments. See "Wedge Quiet Interval" for more detailed programming instructions.



NOTE

This feature applies **ONLY** to the Keyboard Wedge interface.



Select Wedge Quiet Interval Setting

To configure this feature, scan the ENTER/EXIT bar code above, then the bar code at left followed by digits from the Alphanumeric characters in [Appendix D, Keypad](#) representing your desired character(s). End by scanning the ENTER/EXIT bar code again.

Make a mistake? Scan the CANCEL bar code to abort and not save the entry string. You can then start again at the beginning.



CANCEL

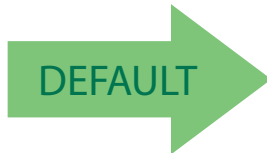

10 = Quiet Interval of 100 ms

Intercharacter Delay

This parameter specifies the intercharacter delay between the end of one character and the beginning of the next. The delay can be set within a range of zero (0) to 990 milliseconds in 10ms increments. A setting of zero specifies no delay. See "Intercharacter Delay" for more detailed programming instructions.



Select Intercharacter Delay Setting

Make a mistake? Scan the CANCEL bar code to abort and not save the entry string. You can then start again at the beginning.



CANCEL



Intercharacter Delay = No Delay

To configure this feature, scan the ENTER/EXIT bar code above, then the bar code at left followed by digits from the Alphanumeric characters in [Appendix D, Keypad](#) representing your desired character(s). End by scanning the ENTER/EXIT bar code again.

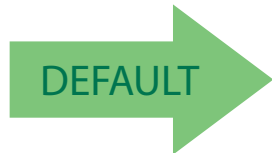

00 = No Intercharacter Delay



Intercode Delay

Specifies the delay between labels transmitted to the host for this interface. The selectable range for this feature is from 0 to 99 seconds. See "Intercode Delay" for more detailed programming instructions.



Set Intercode Delay

To configure this feature, scan the ENTER/EXIT bar code above, then the bar code at left followed by digits from the Alphanumeric characters in [Appendix D, Keypad](#) representing your desired character(s). End by scanning the ENTER/EXIT bar code again.

Make a mistake? Scan the CANCEL bar code to abort and not save the entry string. You can then start again at the beginning.



CANCEL

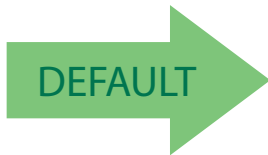

00 = No Wedge Intercode Delay



USB Keyboard Speed

This option specifies the USB poll rate for a USB Keyboard.



NOTE

This feature applies **ONLY** to the USB Keyboard interface.

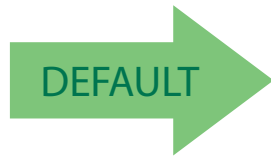

USB Keyboard Speed = 1ms



USB Keyboard Speed = 2ms



USB Keyboard Speed = 3ms



USB Keyboard Speed = 5ms



USB Keyboard Speed = 7ms



USB Keyboard Speed = 10ms



IBM 46XX Interface

Use the bar codes in this section to configure programmable features for available IBM 46XX interfaces.

Reference Appendix B, for a listing of standard factory settings..

Interface Options

This feature provides for an interface-specific control mechanism.



Obey Scanner Configuration Host Commands



Ignore Scanner Configuration Host Commands



Data Format

GLOBAL PREFIX/SUFFIX
GLOBAL AIM ID
GS1-128 AIM ID
LABEL ID <ul style="list-style-type: none">•Label ID: Pre-loaded Sets•Label ID: Set Individually Per Symbology•Label ID Control•Label ID Symbology Selection
CASE CONVERSION
CHARACTER CONVERSION

The features in this chapter can be used to build specific user-defined data into a message string. See "References" for more detailed instructions on setting these features.



Global Prefix/Suffix

Up to 20 ASCII characters may be added as a prefix (in a position before the bar code data) and/or as a suffix (in a position following the bar code data). See "Global Prefix/Suffix" for more detailed programming instructions.

To configure this feature, scan the ENTER/EXIT bar code above, then the bar code at left followed by digits from the Alphanumeric characters in **Appendix D, Keypad** representing your desired character(s). End by scanning the ENTER/EXIT bar code again.



Set Global Prefix

To configure this feature, scan the ENTER/EXIT bar code above, then the bar code at left followed by digits from the Alphanumeric characters in **Appendix D, Keypad** representing your desired character(s). End by scanning the ENTER/EXIT bar code again.



Set Global Suffix

Make a mistake? Scan the CANCEL bar code to abort and not save the entry string. You can then start again at the beginning.



CANCEL

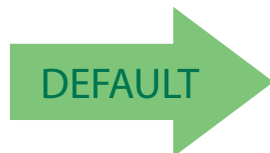

No Global Prefix
Global Suffix = 0x0D(CR)

Global AIM ID



This feature enables/disables addition of AIM IDs for all symbology types.

NOTE

AIM label identifiers (as opposed to custom characters you select yourself as with label identifiers) can be included with scanned bar code data. See "Global AIM ID" for more detailed programming instructions.

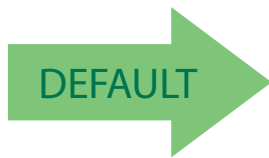

Global AIM ID = Disable



Global AIM ID = Enable

GS1-128 AIM ID

If Global AIM ID is disabled, the AIM ID for GS1-128 can be enabled/disabled independently. The AIM ID for GS1-128 is a]C1,]C2. AIM IDs for other symbologies can be enabled/disabled independently as well. Contact Customer Support for assistance.



GS1-128 AIM ID = Disable



GS1-128 AIM ID = Enable





Label ID

A Label ID is a customizable code of up to three ASCII characters (each can be one of hex 0x01–0xFF), used to identify a bar code (symbology) type. It can be appended previous to or following the transmitted bar code data depending upon how this option is enabled. This feature provides options for configuring custom Label IDs as a pre-loaded set (see "Label ID: Pre-loaded Sets") or individually per symbology (see "Label ID: Set Individually Per Symbology"). If you wish to program the scanner to always include an industry standard label identifier for ALL symbology types, see the previous feature "Global AIM ID".

Label ID: Pre-loaded Sets

The scanner supports two pre-loaded sets of Label IDs, the USA set and the EU set. See "Label ID: Pre-loaded Sets" for more information concerning the pre-loaded sets that are provided.



CAUTION

When changing from one Label ID set to another, all other scanner configuration settings, including the host interface type, will be erased and set to the factory defaults. Any custom configuration or custom defaults will be lost.

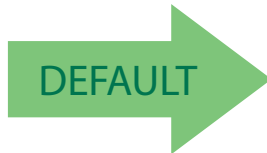

Label ID Pre-loaded Set = USA Set



Label ID Pre-loaded Set = EU Set

Label ID: Set Individually Per Symbology

This feature configures a Label ID individually for a single symbology.



NOTE

This setting requires the scanning of bar codes from multiple sections. See "Label ID:Set Individually Per Symbology" for more detailed programming instructions.

Label ID Control

This option controls whether a Label ID is disabled, or sent as a prefix or suffix for a given symbology type.

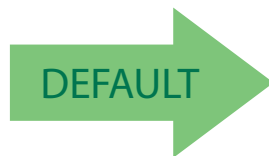

Label ID Transmission = Disable



Label ID Transmission = Enable as Prefix



Label ID Transmission = Enable as Suffix



Label ID Symbology Selection

This option selects the symbology for which a Label ID is to be configured. See "Label ID: Set Individually Per Symbology" for full instructions.



CANCEL

Make a mistake? Scan the CANCEL bar code to abort and not save the entry string. You can then start again at the beginning.



Set UPC-A Label ID Character(s)



Set UPC-A/P2 Label ID Character(s)



Set UPC-A/P5 Label ID Character(s)



Set UPC-E Label ID Character(s)



Set UPC-E/P2 Label ID Character(s)



Set UPC-E/P5 Label ID Character(s)



Label ID Symbology Selection (continued)



Set EAN 13 Label ID Character(s)



Set EAN 13/P2 Label ID Character(s)



Set EAN 13/P5 Label ID Character(s)



Set EAN 8 Label ID Character(s)



Set EAN 8/P2 Label ID Character(s)



Set EAN 8/P5 Label ID Character(s)



Label ID Symbology Selection (continued)



Set GS1 DataBar Omnidirectional Label ID Character(s)



Set GS1 DataBar Expanded Label ID Character(s)



Set GS1 DataBar Limited Label ID Character(s)



Set Code 39 Label ID Character(s)



Set Code 32 Label ID Character(s)



Set Code 39 CIP Label ID Character(s)



Label ID Symbology Selection (continued)



Set Code 128 Label ID Character(s)



Set GS1-128 Label ID Character(s)



Set Interleaved 2 of 5 Label ID Character(s)



Set Interleaved 2 of 5 CIP HR Label ID Character(s)



Set Datalogic 2 of 5 CIP HR Label ID Character(s)



Set Codabar Label ID Character(s)



Set ABC Codabar Label ID Character(s)



Label ID Symbology Selection (continued)



Set Code 11 Label ID Character(s)



Set Standard 2 of 5 Label ID Character(s)



Set Industrial 2 of 5 Label ID Character(s)



Set ISSN Label ID Character(s)



Set IATA Label ID Character(s)



Set Concatenated ISBT 128 Label ID Character(s)



Set MSI Label ID Character(s)

Set Matrix 2 of 5 Label ID Character(s)

Label ID Symbology Selection (continued)



Set Plessey Label ID Character(s)



Set Concatenated ISBT Label ID Character(s)



Set Anker Plessey Label ID Characters

Case Conversion

This feature allows conversion of the case of all alphabetic characters to upper or lower case.



NOTE

Case conversion affects **ONLY** scanned bar code data, and does not affect Label ID, Prefix, Suffix, or other appended data.

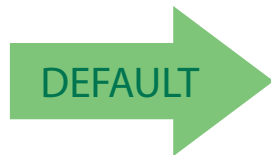

Case Conversion = Disable (no case conversion)



Case Conversion = Convert to upper case



Case Conversion = Convert to lower case



Character Conversion

Character conversion is an eight byte configuration item. The eight bytes are 4 character pairs represented in hexadecimal ASCII values. The first character in the pair is the character that will be converted. The second character in the pair is the character to convert to. If the character to convert in a pair is FF, then no conversion is done. See "Character Conversion" for more detailed programming instructions.



Configure Character Conversion

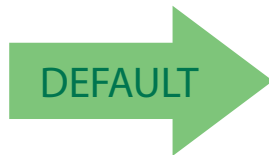

0xFFFFFFFFFFFFFFF
(No character conversion)

Make a mistake? Scan the CANCEL bar code to abort and not save the entry string. You can then start again at the beginning.



CANCEL

Reading Parameters

DOUBLE READ TIMEOUT	GOOD READ SPEAKER VOLUME/VIBRATION
READING PERFORMANCE	GOOD READ BEEP LENGTH
LED AND SPEAKER INDICATORS	GOOD READ LED DURATION
GOOD READ: WHEN TO INDICATE	SCANNING FEATURES
GOOD READ BEEP TYPE	CORDED ONLY FEATURES
GOOD READ BEEP FREQUENCY	MULTIPLE LABEL READING



Double Read Timeout

To prevent a double read of the same label, the Double Read Timeout sets the minimum time allowed between reads of labels of the same symbology and data. If the unit reads a label and sees the same label again within the Double Read Timeout, the second read of the label will be ignored. Double Read Timeout does not apply to scan modes that require a trigger pull for each label that is read.



Double Read Timeout = 0.1 Second



Double Read Timeout = 0.2 Second



Double Read Timeout = 0.3 Second



Double Read Timeout = 0.4 Second



Double Read Timeout (continued)



Double Read Timeout = 0.5 Second



Double Read Timeout = 0.6 Second



Double Read Timeout = 0.7 Second



Double Read Timeout = 0.8 Second



Double Read Timeout = 0.9 Second



Double Read Timeout = 1 Second



Reading Performance

When the barcode scanner's Scan Mode is set to triggerless modes (e.g. Flashing, Always On, Stand Mode/Object Detection, etc.) the reading capabilities can be modified according to two main goals:

- Motion tolerance: increased performance for rapidly moving barcodes.
- Depth of field: increased performance for distant barcodes.

Depending on specific environmental conditions or user's circumstances or expected performances, one may decide to assign a higher priority to one or the other.



Depth of field



Motion tolerance





LED and Speaker Indicators

Power On Alert

Disables or enables the indication (from the Speaker) that the scanner is receiving power.



Power On Alert = Disable (No Audible Indication)



Power On Alert = Power-up Beep





Good Read: When to Indicate

This feature specifies when the scanner will provide indication (beep and/or LED) upon successfully reading a bar code. Choices are:

- Good Read = Indicate after decode
- Good Read = Indicate after transmit
- Good Read = Indicate after CTS goes inactive, then active



NOTE

This option, which uses CTS, is only valid for RS-232 interfaces.

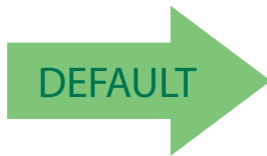

Indicate Good Read = After Decode



Indicate Good Read = After Transmit



Indicate Good Read = After CTS Goes Inactive, Then Active



Good Read Beep Type

Specifies whether the good read beep has a mono or bitonal beep sound.



Good Read Beep Type = Mono



Good Read Beep Type = Bitonal

Good Read Beep Frequency

Adjusts the good read beep to sound at a selectable low, medium or high frequency, selectable from the list below. (Controls the speaker's pitch/tone.)



Good Read Beep Frequency = Low



Good Read Beep Frequency = Medium



Good Read Beep Frequency = High



Good Read Speaker Volume / Vibration

Selects the speaker volume (loudness) upon a good read beep. There are three selectable volume levels.

In addition to three selectable volume levels, the user can also activate a vibration feedback for good read.



Good Read Speaker Volume = Speaker Off



Good Read Speaker Volume = Low



Good Read Speaker Volume = Medium



Good Read Speaker Volume = High



Vibration Feedback for Good Read



Enable Vibration



Enable Vibration = Disable



Silent Mode

If needed, audible indications can be disabled by scanning the labels below. Please note that some important audible notifications are not muted in silent mode and other notifications are replaced by vibration or visual indications.

All changes in audible notifications are summarized here:

- Good Read beep is replaced with vibration
- Power on beep is replaced with vibration
- Connection / Disconnection / out of radio range beeps are replaced with **blue LED and vibration**
- Error beep, RF Error/timeout beeps, chirp beeps are replaced with **red 3GL** and vibration



Silent Mode Enable



Silent Mode OFF



Good Read Beep Length

Specifies the duration of a good read beep.



Good Read Beep Length = 60 msec



Good Read Beep Length = 80 msec



DEFAULT



Good Read Beep Length = 100 msec



Good Read Beep Length = 120 msec



Good Read Beep Length = 140 msec



Good Read Beep Length = 160 msec

Good Read Beep Length (continued)

Good Read Beep Length = 180 msec

Good Read Beep Length = 200 msec

Enable/Disable Good Read Indicator

Enable/Disable the good read indicator.

Good Read Indicator = Disable

Good Read Indicator = Enable





Good Read LED Duration

This feature specifies the amount of time that the Good Read LED remains on following a good read. The good read LED on time can be set within a range of 100 milliseconds to 25,500 milliseconds (0.1 to 25.5 seconds) in 100ms increments. A setting of 00 keeps the LED on until the next trigger pull.

See Chapter 4, References for detailed instructions and examples for setting this feature.



Good Read LED Duration Setting =
Keep LED on until next trigger pull



Select Good Read LED Duration Setting

To configure this feature, scan the ENTER/EXIT PROGRAMMING MODE bar code above, then the bar code at left followed by the digits from the Alphanumeric characters in Appendix D, Keypad representing your desired character(s). End by scanning the ENTER/EXIT bar code.

Make a mistake? Scan the CANCEL bar code to abort and not save the entry string. You can then start again at the beginning.



CANCEL

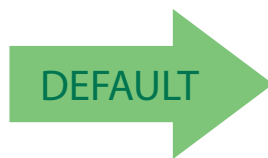

003 = Good Read LED stays on for 300 ms.



NOTE

Indicators are dimmed during sleep.



Scanning Features

Scan Mode

See "Scan Mode" for more detailed programming instructions.



Scan Mode = Trigger Single



DEFAULT



Scan Mode = Trigger Hold Multiple



Scan Mode = Trigger Pulse Multiple



Scan Mode = Flashing



Scan Mode = Always On



Scan Mode = Object Detection



Scan Mode = Trigger Object Sense



Flash On Time

This feature specifies the ON time for the indicator LED while in Flash Mode. The selectable range is 100 to 9,900 milliseconds (0.1 to 9.9 seconds), in 100 millisecond increments. See "Flash On Time" for more detailed pro-gramming instructions.



Select Flash ON Time Setting

To configure this feature, scan the ENTER/EXIT bar code above, then the bar code at left followed by digits from the Alphanumeric characters in [Appendix D, Keypad](#) representing your desired character(s). End by scanning the ENTER/EXIT bar code again.

Make a mistake? Scan the CANCEL bar code to abort and not save the entry string. You can then start again at the beginning.



CANCEL

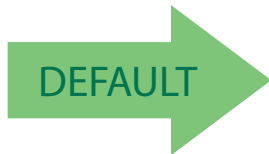

10 = Flash is ON for 1 Second



Flash Off Time

This feature specifies the OFF time for the indicator LED while in Flash Mode. The selectable range is 100 to 9,900 milliseconds (0.1 to 9.9 seconds), in 100 millisecond increments. See "Flash Off Time" for more detailed programming instructions.



Select Flash OFF Time Setting

To configure this feature, scan the ENTER/EXIT bar code above, then the bar code at left followed by digits from the Alphanumeric characters in [Appendix D, Keypad](#) representing your desired character(s). End by scanning the ENTER/EXIT bar code again.

Make a mistake? Scan the CANCEL bar code to abort and not save the entry string. You can then start again at the beginning.



CANCEL

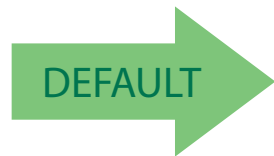

06 = Flash is OFF for 600ms



Object Detection Indication

Enables/disables the LED flash when the reader is in Object Detection.

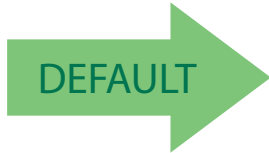

Object Detection Flash = Disable



Object Detection Flash = Enable



Stand Operation

Specifies the behavior of the reader when stationary in a stand. There are two conditions which cause the reader to switch to Stand Mode/Object Detection:

1. The reader is configured to switch to Stand Mode/Object Detection when stationary.
2. The reader is placed into the cradle of the base station.

Below are further options concerning Stand Operation.

Ignore Autorecognition. Disables mode switching when the reader is placed in a stand.

Switch to Stand Mode/Object Detection. Automatically switches the reader to Stand Mode/Object Detection when the reader is placed in the stand.

Switch to Flashing. Automatically switches the reader to Flash Mode when the reader is placed in the stand.

Switch to Always On. Automatically switches the reader to Always On mode when the reader is placed in the stand.

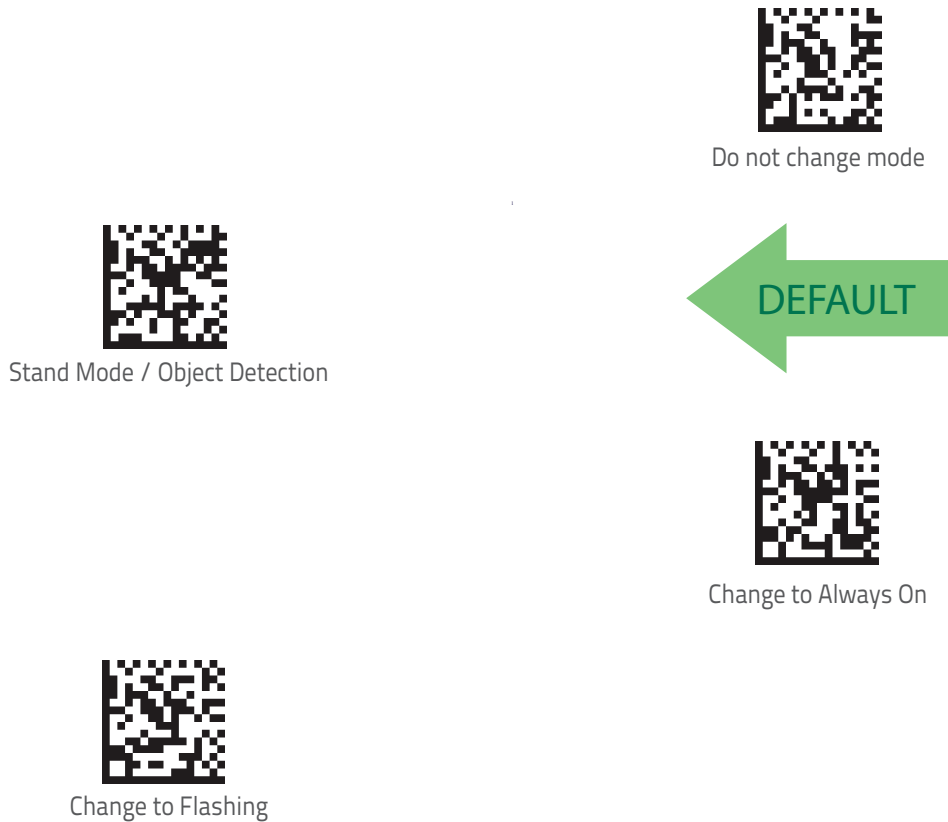



Stand Mode/Object Detection Sensitivity

Sets the sensitivity level for stand mode/object detection wakeup. Choices are low, medium and high.



Stand Mode/Object Detection Sensitivity = Low



Stand Mode/Object Detection Sensitivity = Medium



Stand Mode/Object Detection Sensitivity = High



Stand Mode/Object Detection Illumination Off Time

Specifies the amount of time reader illumination stays off after pulling the trigger when in Stand Mode/Object Detection. The configurable range is 01 to 32 by 01 in increments of 500ms (500ms to 16 seconds).



Select Stand Mode Time Setting

To configure this feature, scan the ENTER/EXIT PROGRAMMING MODE bar code above, then the bar code at left followed by the digits from the Alphanumeric characters in [Appendix D, Keypad](#) representing your desired character(s). End by scanning the ENTER/EXIT bar code again.

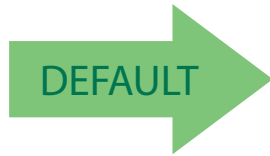

04 = 2 Seconds

Illumination Intensity and Frequency

With the following settings the illumination intensity can be reduced if needed. Not all hardware versions support this function. Please contact Technical Support for more information.

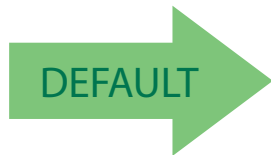

Full Intensity



Reduced Intensity



Illuminator Refresh Frequency

Illuminator refresh frequency can be increased if needed. In some conditions this can contribute to eye relaxation.

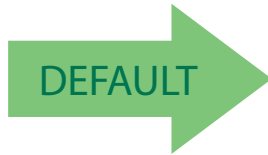

Normal Refresh Frequency



Increased Refresh Frequency

Scanning Active Time

This setting specifies the amount of time that the reader stays in scan ON state once the state is entered. The range for this setting is from 1 to 255 seconds in 1-second increments. See “References” for further description of this feature.



Scanning Active Time = 3 seconds



Scanning Active Time = 5 seconds



Scanning Active Time = 8 seconds



Motion Still Timeout

Motion Still Timeout specifies the waiting time after which no motions is detected. When no motion is detected for period of time longer than the set Motion Still Timeout period, the scanner assumes it is in a motionless condition. The selectable setting are from 500 to 25,500 milliseconds in 100 millisecond increments. The default is 2 seconds. This option relates to such features and the Aimer On timing and Stand Mode / Object Detection scanning with respect to motion.



Select Motion Still Timeout Setting

To configure this feature, scan the ENTER/EXIT PROGRAMMING MODE bar code above, then the bar code at left followed by the digits from the Alphanumeric characters in [Appendix D, Keypad](#) representing your desired character(s). End by scanning the ENTER/EXIT bar code again.

Make a mistake? Scan the CANCEL bar code to abort and not save the entry string. You can then start again at the beginning.



CANCEL

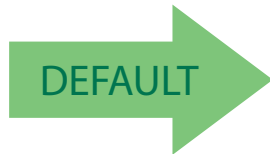

14 = Motion Still Timeout for 2 seconds



Pick Mode

Specifies the ability of the reader to decode labels only when they are close to the center of the aiming pattern. This allows the reader to accurately target labels when they are placed close together, such as on a pick sheet.

The Pick Mode can be enabled only in Trigger Single Scan Mode.



NOTE

This feature is not compatible with Multiple Labels Reading in a Volume.

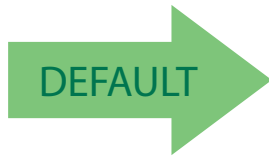

Pick Mode = Disable



Pick Mode = Enable

Aiming Pointer

Enables/disables the aiming pointer for all symbologies.



Aiming Pointer = Disable



Aiming Pointer = Enable





Use Green Spot as Aiming Pointer

Aiming Duration Timer

Specifies the frame of time the aiming pointer remains on after decoding a label, when in trigger single mode. The range for this setting is from 1 to 255 seconds in 1-second increments. See “References” for a description of this feature.

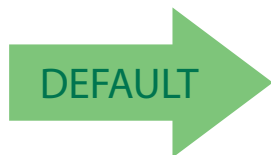

Set Aiming Duration Timer



Aiming Off After Decoding

To configure, scan the ENTER/EXIT PROGRAMMING MODE bar code above, then the bar code at left followed by the digits from the Alphanumeric characters in [Appendix D, Keypad](#) representing your desired character(s). End by scanning the ENTER/EXIT bar code.

Make a mistake? Scan the CANCEL bar code to abort and not save the entry string. You can then start again at the beginning.



CANCEL



Green Spot Duration

Specifies the duration of the good read pointer beam after a good read.



Green Spot Duration = Disable (Green Spot is Off)



Green Spot Duration = Short (300 msec)



Green Spot Duration = Medium (500 msec)



Green Spot Duration = Long (800 msec)



Mobile Phone Mode

This mode is useful for scanning bar codes displayed on a mobile phone. Other options for this feature can be configured using the HP Barcode Scanner D-Series Configuration Utility.



Mobile Phone Mode = Enable



Mobile Phone Mode = Disable



DEFAULT



Mobile Phone Mode = Enhanced



Mobile Phone Saturation Rate

This specifies the minimum number of saturated pixels (every 1000 pixels) in the image in order to activate the Mobile Phone mode.

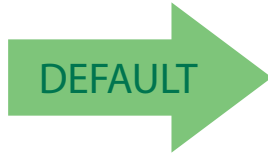

Mobile Phone Saturation Rate = 00



Mobile Phone Saturation Rate = 01



Mobile Phone Saturation Rate = 02



Decode Negative Image

Enable/Disable the ability to decode a negative image for all symbologies. When this feature is enabled, you will be unable to read normally-printed labels or programming labels in this manual. Scan the “Disable” bar code below to return the scanner to its default for this feature. To set decoding for only 2D codes, go to “2D Normal/Inverse Symbol Control”. For additional options, see the HP Barcode Scanner D-Series Configuration Utility.



NOTE

Unlike some programming features and options, Decode Negative Image selections require that you scan only one programming bar code label. **DO NOT** scan an ENTER/EXIT bar code prior to scanning a Decode Negative Image bar code.



CAUTION

When this feature is enabled, you will be unable to read other programming labels in this manual.

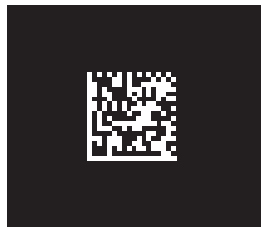

Decode Negative Image = Disable



DEFAULT



Decode Negative Image = Enable

Image Capture

For information and a list of options for Image Capture, use the HP Barcode Scanner D-Series Configuration Utility, available for free download from the HP website.



CORDED ONLY FEATURES

Corded Stand Mode

Sets the Stand Mode Operation for Corded models



NOTE

This feature is available starting with firmware release 610001013.

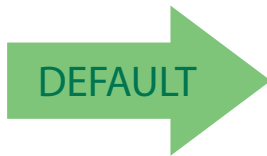

Corded Stand Mode = Disable



Corded Stand Mode = Generic Stand



Corded Stand Mode = for All-in-one and Base



Corded Stand Mode = Precise Stand



Dock Detection Beep

If enabled, when the Handheld reader is placed in a dock (cradle or corded stand), it will beep.



Dock Detection Beep = Disable



Dock Detection Beep = Enable

Corded Stand Beep

Enables/Disables the beep that indicates when Corded Stand position is detected.



This feature is available starting on firmware release 610001013.

NOTE



Corded Stand Beep = Disable



Corded Stand Beep = Enable



MULTIPLE LABEL READING

In standard (default) mode, when the reader's aiming system is activated (by a trigger pull, motion or other method depending on the mode), it then acquires and processes each image in the area in front of it (the Volume). In this case, the scanner stops processing the image once it decodes a label. If several labels are present in the volume, only the first label encountered is decoded and sent.

When Multiple Reading Mode is enabled, the scanner keeps on processing the image until all the labels present are decoded. The reader then sorts the data from all the bar codes (if configured to do so) before transmitting it.

Multiple Labels per Frame

Specifies the ability of the reader to decode and transmit a set of code labels in a specific volume and in a single frame of time. When in Multiple Labels per Frame the reader beeps and turns on the good read LED indication for each code read in a frame.

When Multiple Labels Mode is enabled, ISBT pairing, ABC Codabar pairing, and composites are not allowed.

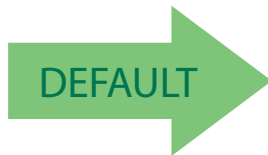

Multiple Labels per Frame = Disable



Multiple Labels per Frame = Enable



Multiple Labels Ordering by Code Symbology

This feature allows you to specify the order multiple labels are transmitted by symbology type, when Multiple Labels per Frame is enabled.



Select Symbologies for Multiple Labels Ordering

To configure this feature, scan the ENTER/EXIT PROGRAMMING MODE bar code above, then the bar code at left followed by the digits From the alphanumeric characters In Appendix d, keypad representing your desired Character(s). end by scanning the enter/exit bar code again.

Make a mistake? Scan the CANCEL bar code to abort and not save the entry string. You can then start again at the beginning.



CANCEL

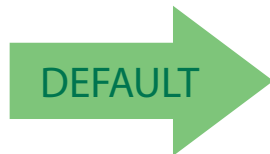

00000000000 = Random order

Multiple Labels Ordering by Code Length

Specifies the transmission ordering by code length, when Multiple Labels per Frame is enabled.

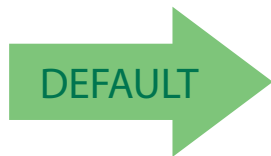

Multiple Labels Ordering = Disable



Transmit Increasing Length Order



Transmit Decreasing Length Order

NOTES

1D Symbologies

Introduction

The scanner supports the following 1D symbologies (bar code types). Symbology-dependent options for each symbology are included in this chapter. See "2D Symbologies" for configuration of 2D bar codes.

UPC-A	INTERLEAVED 2 OF 5 (I 2 OF 5)
UPC-E	INTERLEAVED 2 OF 5 CIP HR
EAN 13	DATALOGIC 2 OF 5
EAN 13	CODABAR
EAN 8	ABC CODABAR
ADD-ONS	CODE 11
GS1 DATABAR™ OMNIDIRECTIONAL	STANDARD 2 OF 5
GS1 DATABAR™ EXPANDED	INDUSTRIAL 2 OF 5
GS1 DATABAR™ LIMITED	IATA
CODE 39	ISBT 128
CODE 32 (ITALIAN PHARMACEUTICAL)	MSI
CODE 39 CIP (FRENCH PHARMACEUTICAL)	CODE 93
CODE 128	FOLLETT 2 OF 5
GS1-128	BC412

Standard Factory Settings for Symbologies

Default settings are indicated at each feature/option with a green arrow. Also reference [Appendix B](#), for a listing of the most widely used set of standard factory settings. That section also provides space to record any custom settings needed or implemented for your system.



Disable All Symbologies

Scan this label to disable all symbologies.



Disable all symbologies

Coupon Control

This feature is used to control the method of processing coupon labels.

Options are:

- Allow all — allow all coupon bar codes to be decoded
- Enable only UPC/EAN — enables only UPC/EAN coupon decoding
- Enable only GS1 DataBar — enables only GS1 DataBar coupon decoding

To set this feature:

1. Scan the Enter/Exit bar code.
2. Scan either the enable or disable bar code below. You'll need to cover any unused bar codes on this and the facing page to ensure that the scanner sees only the bar code you intend to scan.
3. Complete the programming sequence by scanning the Enter/Exit bar code.



Coupon Control = Allow all



Coupon Control = Enable only UPC/EAN



Coupon Control = Enable only GS1 DataBar

UPC-A

The following options apply to the UPC-A symbology.

UPC-A Enable/Disable

When disabled, the scanner will not read UPC-A bar codes.



UPC-A Check Character Transmission

Enable this option to transmit the check character along with UPC-A bar code data.





Expand UPC-A to EAN-13

Expands UPC-A data to the EAN-13 data format. Selecting this feature also changes the symbology ID to match those required for EAN-13.

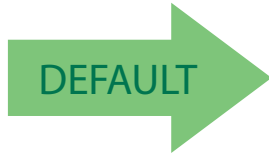

UPC-A to EAN-13 = Don't Expand



UPC-A to EAN-13 = Expand

UPC-A Number System Character Transmission

This feature enables/disables transmission of the UPC-A number system character.



UPC-A Number System Character = Do not transmit



UPC-A Number System Character = Transmit



UPC-A 2D Component

This feature enables/disables a requirement that a 2D label component be decoded when a base label of this symbology is decoded.

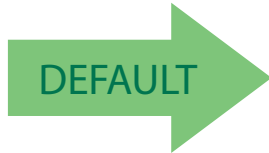

UPC-A 2D Component =
Disable (2D component not required)



UPC-A 2D Component =
Enabled (2D component must be decoded)



UPC-E

The following options apply to the UPC-E symbology.

UPC-E Enable/Disable

When disabled, the scanner will not read UPC-E bar codes.



UPC-E = Disable



UPC-E = Enable



UPC-E Check Character Transmission

Enable this option to transmit the check character along with UPC-E bar code data.



UPC-E Check Character Transmission = Don't Send



UPC-E Check Character Transmission = Send



UPC-E 2D Component

This feature enables/disables a requirement that a 2D label component be decoded when a base label for this symbology is decoded.

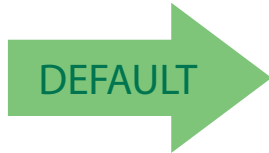

UPC-E 2D Component =
Disable (2D component not required)



UPC-E 2D Component =
2D component must be decoded



Expand UPC-E to EAN-13

Expands UPC-E data to the EAN-13 data format. Selecting this feature also changes the symbology ID to match those required for EAN-13.

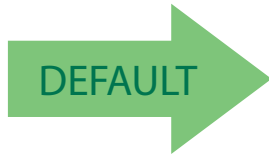

UPC-E to EAN-13 = Don't Expand



UPC-E to EAN-13 = Expand

Expand UPC-E to UPC-A

Expands UPC-E data to the UPC-A data format.

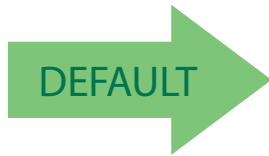

UPC-E to UPC-A = Don't Expand



UPC-E to UPC-A = Expand

UPC-E Number System Character Transmission

This feature enables/disables transmission of the UPC-E system number character.



UPC-E Number System Character = Do not transmit



UPC-E Number System Character = Transmit



GTIN Formatting

This feature enables/disables the ability to convert UPC-E, UPC-A, EAN 8, and EAN 13 labels into the GTIN 14-character format.



If add-on information is present on the base label prior to the conversion taking place, the add-on information will be appended to the converted GTIN label.

NOTE

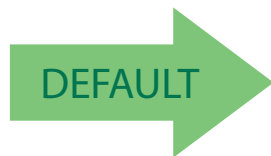

GTIN Formatting = Enable



GTIN Formatting = Disable



EAN 13

The following options apply to the EAN 13 (Jan 13) symbology.

EAN 13 Enable/Disable

When disabled, the scanner will not read EAN 13/JAN 13 bar codes.



EAN 13 = Disable



EAN 13 = Enable



EAN 13 Check Character Transmission

Enable this option to transmit the check character along with EAN 13 bar code data.



EAN 13 Check Character Transmission = Don't Send



EAN 13 Check Character Transmission = Send



EAN-13 Flag 1 Character

Enables/disables transmission of an EAN/JAN13 Flag1 character. The Flag 1 character is the first character of the label.

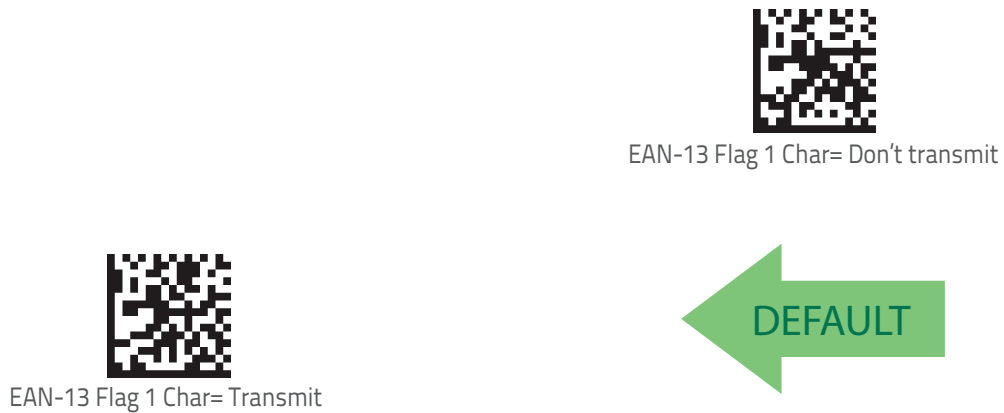

EAN-13 ISBN Conversion

This option enables/disables conversion of EAN 13/JAN 13 Bookland labels starting with 978 to ISBN labels.

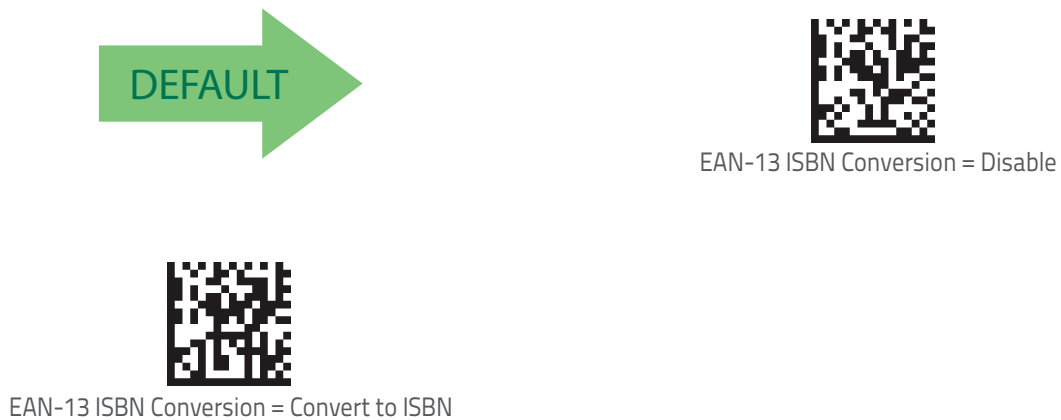



EAN-13 2D Component

This feature enables/disables a requirement that a 2D label component be decoded when a base label of this symbology is decoded.

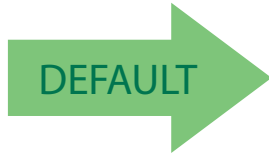

EAN-13 2D Component =
Disable (2D component not required)



EAN-13 2D Component =
2D component must be decoded

ISSN Enable/Disable

Enables/disables conversion of EAN/JAN 13 Bookland labels starting with 977 to ISSN labels.

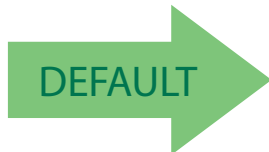

ISSN = Disable



ISSN = Enable

EAN 8

The following options apply to the EAN 8 (Jan 8) symbology.

EAN 8 Enable/Disable

When disabled, the scanner will not read EAN 8/JAN 8 bar codes.



EAN 8 Check Character Transmission

Enable this option to transmit the check character along with EAN 8 bar code data.





Expand EAN 8 to EAN 13

Enable this option to expand EAN 8/JAN 8 labels to EAN 13/JAN 13.

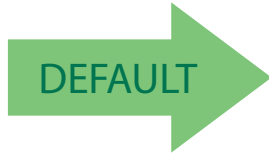

Expand EAN 8 to EAN 13 = Disable



Expand EAN 8 to EAN 13 = Enable

EAN 8 2D Component

This feature enables/disables a requirement that a 2D label component be decoded when a base label for this symbology is decoded.



EAN 8 2D Component =
Disable (2D component not required)



EAN 8 2D Component =
2D component must be decoded

UPC/EAN Global Settings

This section provides configuration settings for UPC-A, UPC-E, EAN 13 and EAN 8 symbologies, and affects all of these unless otherwise marked for each feature description.

UPC/EAN Price Weight Check

This feature enables/disables calculation and verification of price/weight check digits.

Options are

- Disabled
- Enable 4-digit price-weight check-digit calculation
- Enable 5-digit price-weight check-digit calculation
- Enable European 4-digit price-weight check-digit calculation
- Enable European 5-digit price-weight check-digit calculation

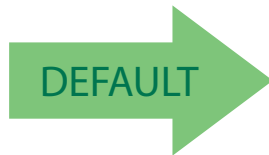

Price Weight Check = Disabled



Price Weight Check = 4-digit price-weight check



Price Weight Check = 5-digit price-weight check



Price Weight Check = European 4-digit price-weight check



Price Weight Check = European 5-digit price-weight check



UPC/EAN Quiet Zones

This feature specifies the number of quiet zones for UPC/EAN labels. Quiet zones are blank areas at the ends of a bar code, typically 10 times the width of the narrowest bar or space in the label. The property applies to all EAN-UPC symbologies globally and to the ADD-ONS.

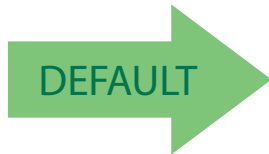

UPC/EAN Quiet Zones = Two Modules



UPC/EAN Quiet Zones = Three Modules

Add-Ons

The following features apply to optional add-ons.



NOTE

Contact Customer Support for advanced programming of optional and conditional add-ons.

Optional Add-ons

The scanner can be enabled to optionally read the following add-ons (supplementals):

- P2
- P5



NOTE

If a UPC/EAN base label and an add-on are both decoded, the scanner will transmit the base label and add-on. If a UPC/EAN base label is decoded without an add-on, the base label will be transmitted without an add-on.

Conditional add-on settings (if enabled) are considered by the scanner before optional add-on settings.

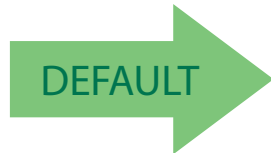

Optional Add-Ons = Disable P2



Optional Add-Ons = Enable P2

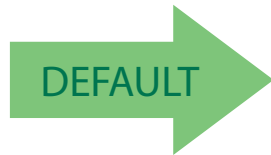

Optional Add-Ons = Disable P5



Optional Add-Ons = Enable P5



Optional Add-On Timer

This option sets the time the scanner will look for an add-on when an add-on fragment has been seen and optional add-ons are enabled.



Optional Add-on Timer = 10ms



Optional Add-on Timer = 20ms



Optional Add-on Timer = 30ms



Optional Add-on Timer = 50ms



Optional Add-on Timer = 70ms



Optional Add-on Timer = 100ms



Optional Add-on Timer = 160ms

Optional GS1-128 Add-On timer

This option sets the timer expiration value to read the added part after reading the linear EAN/UPC part. For UPC/EAN add-ons other than those of that type, see "Optional Add-On Timer".

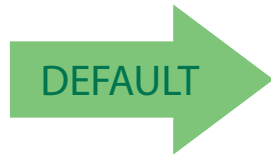

Optional GS1-128 Add-On Timer = Disable



Optional GS1-128 Add-On Timer = 10 ms



Optional GS1-128 Add-On Timer = 20 ms



Optional GS1-128 Add-On Timer = 30 ms



Optional GS1-128 Add-On Timer = 40 ms



Optional GS1-128 Add-On Timer = 50 ms



Optional GS1-128 Add-On Timer = 60 ms



Optional GS1-128 Add-On Timer = 70 ms



Optional GS1-128 Add-On Timer = 100 ms



Optional GS1-128 Add-On Timer = 120 ms



Optional GS1-128 Add-On Timer = 140 ms



Optional GS1-128 Add-On Timer = 160 ms



Optional GS1-128 Add-On Timer = 180 ms



Optional GS1-128 Add-On Timer = 200 ms



Optional GS1-128 Add-On Timer = 220 ms



Optional GS1-128 Add-On Timer = 240 ms



Optional GS1-128 Add-On Timer = 260 ms



Optional GS1-128 Add-On Timer = 280 ms



Optional GS1-128 Add-On Timer = 300 ms

GS1 DataBar™ Omnidirectional

The following options apply to the GS1 DataBar Omnidirectional (formerly RSS-14) symbology.

GS1 DataBar Omnidirectional Enable/Disable

When disabled, the scanner will not read GS1 DataBar Omnidirectional bar codes.

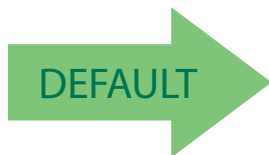

GS1 DataBar Omnidirectional = Disable



GS1 DataBar Omnidirectional = Enable



GS1 DataBar Omnidirectional GS1-128 Emulation

When enabled, GS1 DataBar Omnidirectional bar codes will be translated to the GS1-128 label data format.

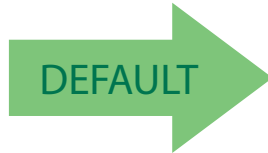

GS1 DataBar Omnidirectional GS1-128 Emulation = Disable



GS1 DataBar Omnidirectional GS1-128 Emulation = Enable

GS1 DataBar™ Omnidirectional 2D Component

This feature enables/disables a requirement that a 2D label component be decoded when a base label for this symbology is decoded.



GS1 DataBar™ Omnidirectional 2D Component = Disable (2D component not required)



GS1 DataBar™ Omnidirectional 2D Component = 2D component must be decoded

GS1 DataBar™ Expanded

The following options apply to the GS1 DataBar Expanded (formerly RSS Expanded) symbology.

GS1 DataBar Expanded Enable/Disable

When disabled, the scanner will not read GS1 DataBar Expanded bar codes.

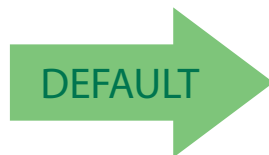

GS1 DataBar Expanded = Disable



GS1 DataBar Expanded = Enable

GS1 DataBar Expanded GS1-128 Emulation

When enabled, GS1 DataBar Expanded bar codes will be translated to the GS1-128 label data format.

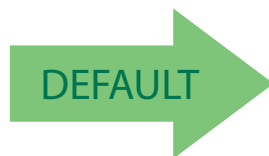

GS1 DataBar Expanded GS1-128 Emulation = Disable



GS1 DataBar Expanded GS1-128 Emulation = Enable



GS1 DataBar Expanded 2D Component

This feature enables/disables a requirement that a 2D label component be decoded when a base label of this symbology is decoded.

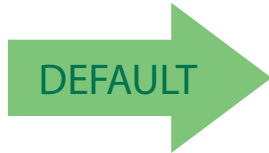

GS1 DataBar Expanded 2D Component = Disable



GS1 DataBar Expanded 2D Component = Enable



GS1 DataBar Expanded Length Control

This feature specifies either variable length decoding or fixed length decoding for the GS1 DataBar Expanded symbology.

Variable Length: For variable-length decoding, a minimum length may be set.

Fixed Length: For fixed-length decoding, two different lengths may be set.

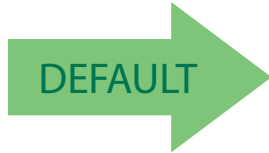

GS1 DataBar Expanded Length Control = Variable Length



GS1 DataBar Expanded Length Control = Fixed Length

GS1 DataBar Expanded Set Length 1

This feature specifies one of the bar code lengths for GS1 DataBar Expanded Length Control. Length 1 is the minimum label length if in Variable Length Mode, or the first fixed length if in Fixed Length Mode. Length includes the bar code's data characters only.

The length can be set from 1 to 74 characters. See "Set Length 1" for more detailed programming instructions.



Select GS1 DataBar Expanded Set Length 1 Setting

To configure this feature, scan the ENTER/EXIT bar code above, then the bar code at left followed by digits from the Alphanumeric characters in **Appendix D, Keypad** representing your desired character(s). End by scanning the ENTER/EXIT bar code again.

Make a mistake? Scan the CANCEL bar code to abort and not save the entry string. You can then start again at the beginning.



CANCEL

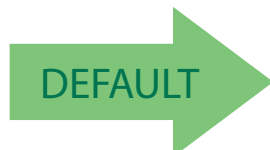

01 = Length 1 is 1 Character



GS1 DataBar Expanded Set Length 2

This feature specifies one of the bar code lengths for GS1 DataBar Expanded Length Control. Length 2 is the maximum label length if in Variable Length Mode, or the second fixed length if in Fixed Length Mode. Length includes the bar code's data characters only.

The length can be set from 1 to 74 characters. A setting of 00 specifies to ignore this length (only one fixed length). See "Set Length 2" for more detailed programming instructions.



Select GS1 DataBar Expanded Set Length 2 Setting

To configure this feature, scan the ENTER/EXIT bar code above, then the bar code at left followed by digits from the Alphanumeric characters in [Appendix D, Keypad](#) representing your desired character(s). End by scanning the ENTER/EXIT bar code again.

Make a mistake? Scan the CANCEL bar code to abort and not save the entry string. You can then start again at the beginning.



CANCEL

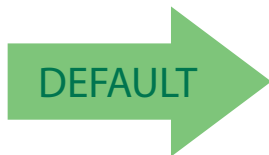

74 = Length 2 is 74 Characters

GS1 DataBar™ Limited

The following options apply to the GS1 DataBar Limited (formerly RSS Limited) symbology.

GS1 DataBar Limited Enable/Disable

When disabled, the scanner will not read GS1 DataBar Limited bar codes.

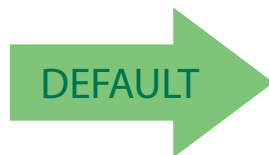

GS1 DataBar Limited = Disable



GS1 DataBar Limited = Enable

GS1 DataBar Limited GS1-128 Emulation

When enabled, GS1 DataBar Limited bar codes will be translated to the GS1-128 label data format.

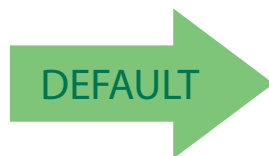

GS1 DataBar Limited GS1-128 Emulation = Disable



GS1 DataBar Limited GS1-128 Emulation = Enable



GS1 DataBar Limited 2D Component

This feature enables/disables a requirement that a 2D label component be decoded when a base label of this symbology is decoded..

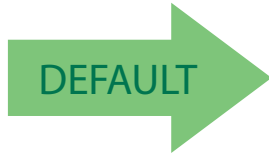

GS1 DataBar Limited 2D Component =
Disable (2D component non required)



GS1 DataBar Limited 2D Component =
2D component must be decoded

Code 39

The following options apply to the Code 39 symbology.

Code 39 Enable/Disable

When disabled, the scanner will not read Code 39 bar codes.



Code 39 Check Character Calculation

Enable this option to enable/disable calculation and verification of an optional Code 39 check character. When disabled, any check character in the label is treated as a data character.

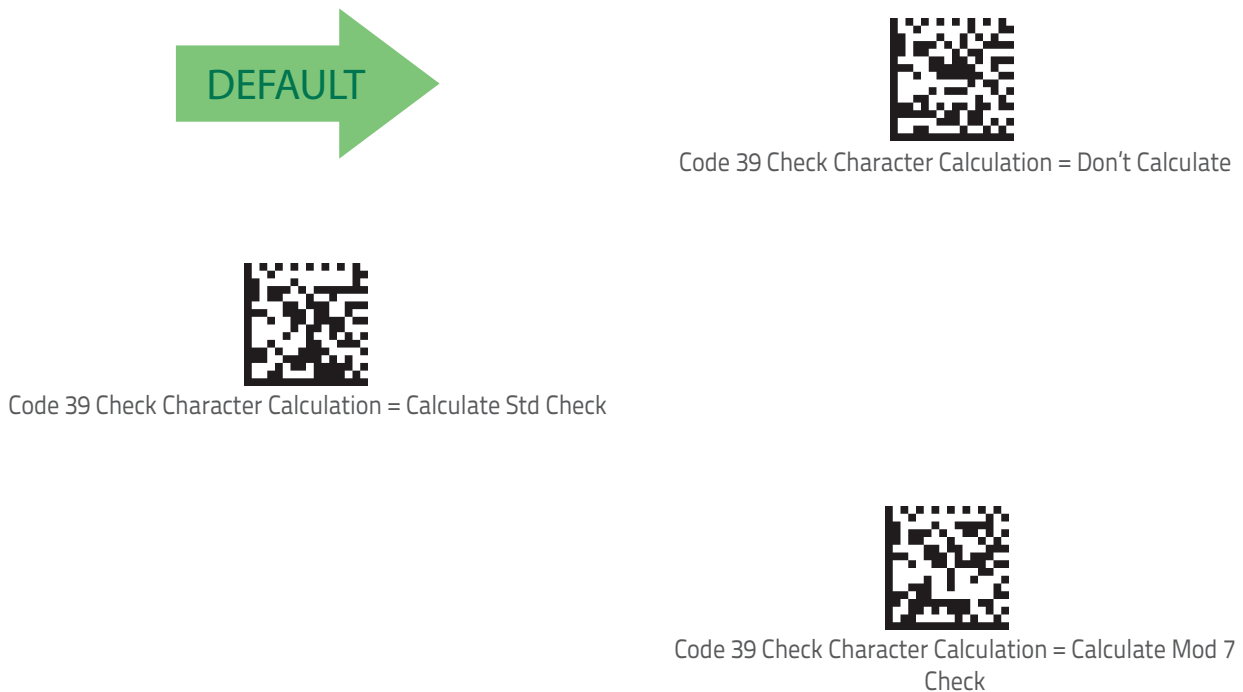



Code 39 Check Character Calculation (continued)



Code 39 Check Character Calculation = Enable Italian Post Check



Code 39 Check Character Calculation = Enable Daimler Chrysler Check

Code 39 Check Character Transmission

Enable this option to transmit the check character along with Code 39 bar code data.



Code 39 Check Character Transmission = Don't Send



Code 39 Check Character Transmission = Send



Code 39 Start/Stop Character Transmission

Enable this option to enable/disable transmission of Code 39 start and stop characters.

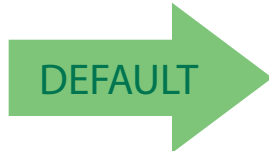

Code 39 Start/Stop Character Transmission = Don't Transmit



Code 39 Start/Stop Character Transmission = Transmit

Code 39 Full ASCII

In Code 39 decoding, this enables/disables the translation of Code 39 characters to Code 39 full-ASCII characters.

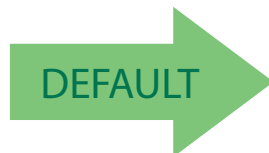

Code 39 Full ASCII = Disable



Code 39 Full ASCII = Enable



Code 39 Quiet Zones

This feature specifies the number of quiet zones for Code 39 labels. Quiet zones are blank areas at the ends of a bar code and are typically 10 times the width of the narrowest bar or space in the label.



Code 39 Quiet Zones = Small Quiet Zones on two sides



Code 39 Quiet Zones = Quiet Zones on two sides



Code 39 Quiet Zones = Small Quiet Zones on two sides



Code 39 Quiet Zones = Small Quiet Zones on two sides



Code 39 Quiet Zones = Small Quiet Zones on two sides

Code 39 Length Control

This feature specifies either variable length decoding or fixed length decoding for the Code 39 symbology.

Variable Length: For variable length decoding, a minimum and maximum length may be set.

Fixed Length: For fixed length decoding, two different lengths may be set.

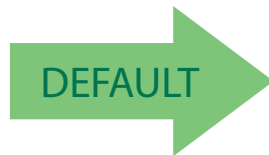

Code 39 Length Control = Variable Length



Code 39 Length Control = Fixed Length



Code 39 Set Length 1

This feature specifies one of the bar code lengths for Code 39 Length Control. Length 1 is the minimum label length if in Variable Length Mode, or the first fixed length if in Fixed Length Mode. Length includes the bar code's check, data, and full-ASCII shift characters. The length does not include start/stop characters.

The length can be set from 0 to 50 characters. See "Set Length 1" for more detailed programming instructions.



Select Code 39 Set Length 1 Setting

To configure this feature, scan the ENTER/EXIT bar code above, then the bar code at left followed by digits from the Alphanumeric characters in [Appendix D, Keypad](#) representing your desired character(s). End by scanning the ENTER/EXIT bar code again.

Make a mistake? Scan the CANCEL bar code to abort and not save the entry string. You can then start again at the beginning.



CANCEL

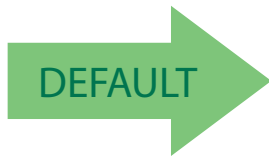

02 = Length 1 is 2 Characters

Code 39 Set Length 2

This feature specifies one of the bar code lengths for **Code 39 Length Control**. Length 2 is the maximum label length if in **Variable Length Mode**, or the second fixed length if in **Fixed Length Mode**. Length includes the bar code's check, data, and full-ASCII shift characters. The length does not include start/stop characters.

The length can be set from 1 to 50 characters. A setting of 00 specifies to ignore this length (only one fixed length). See "Set Length 2" for more detailed programming instructions.



Select Code 39 Length 2 Setting

To configure this feature, scan the ENTER/EXIT bar code above, then the bar code at left followed by digits from the Alphanumeric characters in **Appendix D, Keypad** representing your desired character(s). End by scanning the ENTER/EXIT bar code again.

Make a mistake? Scan the CANCEL bar code to abort and not save the entry string. You can then start again at the beginning.



CANCEL

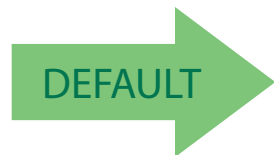

50 = Length 2 is 50 Characters



TRIOPTIC CODE

The following options apply to the Trioptic symbology.

Trioptic Code Enable/Disable

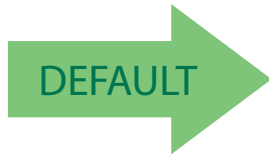

Trioptic Code = Disable



Trioptic Code = Enable

CODE 39 DANISH PPT

The following options apply to the Code 39 Danish PPT symbology.

Code 39 Danish PPT Enable/Disable

Enables/Disables AIM ID for Code 39 Danish PPT Codes.

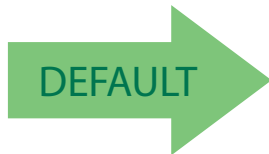

Code 39 Danish PPT = Disable



Code 39 Danish PPT = Enable

CODE 39 PZN

The following options apply to the Code 39 PZN symbology.

Code 39 PZN Enable/Disable

Enables/Disables the ability of the scanner to decode Code 39 PZN labels.

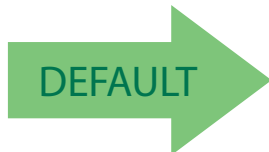

Code 39 PZN = Disable



Code 39 PZN = Enable

CODE 39 LAPOSTE

The following options apply to the Code 39 LaPoste symbology.

Code 39 LaPoste Enable/Disable

Enables/Disables the ability of the scanner to decode Code 39 LaPoste labels.

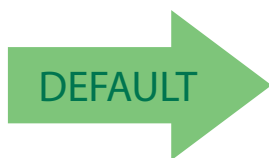

Code 39 LaPoste = Disable



Code 39 LaPoste = Enable



Code 32 (Italian Pharmaceutical)

The following options apply to the Code 32 symbology.

Code 32 Enable/Disable

When disabled, the scanner will not read Code 32 bar codes.

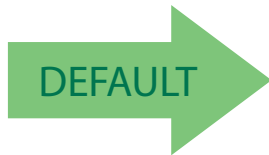

Code 32 = Disable



Code 32 = Enable

Code 32 Feature Setting Exceptions



NOTE

The following features are set for Code 32 by using these Code 39 settings:
"Code 39 Quiet Zones"
"Code 39 Length Control"

Code 32 Check Character Transmission

Enable this option to transmit the check character along with Code 32 bar code data.

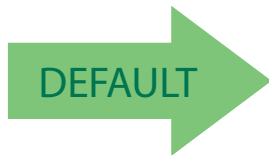

Code 32 Check Character Transmission = Don't Send



Code 32 Check Character Transmission = Send

Code 32 Start/Stop Character Transmission

This option enables/disables transmission of Code 32 start and stop characters.

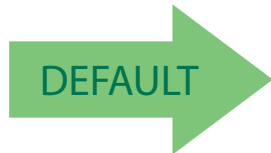

Code 32 Start/Stop Character Transmission = Don't Transmit



Code 32 Start/Stop Character Transmission = Transmit

Code 39 CIP (French Pharmaceutical)

The following options apply to the Code 39 CIP symbology.

Code 39 CIP Enable/Disable

Enables/Disables ability of the scanner to decode Code 39 CIP labels.



Code 39 CIP = Disable



Code 39 CIP = Enable



Code 128

The following options apply to the Code 128 symbology.

Code 128 Enable/Disable

When disabled, the scanner will not read Code 128 bar codes.



Code 128 = Disable



Code 128 = Enable



Expand Code 128 to Code 39

This feature enables/disables expansion of Code 128 labels to Code 39 labels. When enabled, the label identifier for a Code 128 label shall be set to Code 39 and all Code 39 formatting control shall be applied to the label.

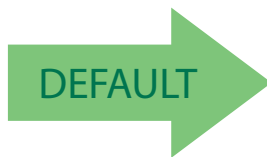

Code 128 to Code 39 = Don't Expand



Code 128 to Code 39 = Expand

Code 128 Check Character Transmission

Enable this option to transmit the check character along with Code 128 bar code data.

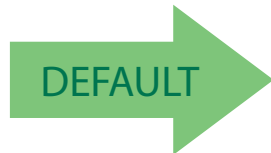

Code 128 Check Character Transmission = Don't Send



Code 128 Check Character Transmission = Send

Code 128 Function Character Transmission

Enables/disables transmission of Code 128 function characters 1, 2, 3, and 4.

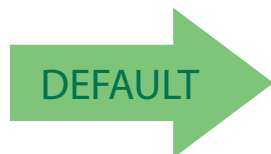

Code 128 Function Character Transmission = Don't Send



Code 128 Function Character Transmission = Send



Code 128 Quiet Zones

This feature specifies the number of quiet zones for Code 128 labels. Quiet zones are blank areas at the ends of a bar code and are typically 10 times the width of the narrowest bar or space in the label.



Code 128 Quiet Zones = No Quiet Zones



Code 128 Quiet Zones = Quiet Zone on one side



Code 128 Quiet Zones = Quiet Zones on two sides



Code 128 Quiet Zones = Auto



Code 128 Quiet Zones = Virtual Quiet Zones on two sides



Code 128 Length Control

This feature specifies either variable length decoding or fixed length decoding for the Code 128 symbology.

Variable Length: For variable length decoding, a minimum and maximum length may be set.

Fixed Length: For fixed length decoding, two different lengths may be set.

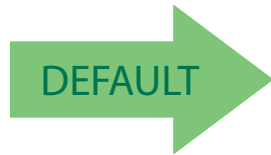

Code 128 Length Control = Variable Length



Code 128 Length Control = Fixed Length

Code 128 Set Length 1

This feature specifies one of the bar code lengths for Code 128 Length Control. Length 1 is the minimum label length if in Variable Length Mode, or the first fixed length if in Fixed Length Mode. Length includes the bar code's data characters only.

The length can be set from 1 to 80 characters. See "Set Length 1" for more detailed programming instructions.



Select Code 128 Set Length 1 Setting

To configure this feature, scan the ENTER/EXIT bar code above, then the bar code at left followed by digits from the Alphanumeric characters in [Appendix D, Keypad](#) representing your desired character(s). End by scanning the ENTER/EXIT bar code again.

Make a mistake? Scan the CANCEL bar code to abort and not save the entry string. You can then start again at the beginning.

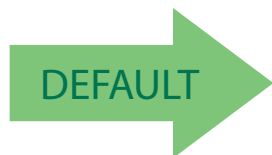

01 = Length 1 is 1 Character



Code 128 Set Length 2

This feature specifies one of the bar code lengths for Code 128 Length Control. Length 2 is the maximum label length if in Variable Length Mode, or the second fixed length if in Fixed Length Mode. Length includes the bar code's data characters only.

The length can be set from 1 to 80 characters. A setting of 00 specifies to ignore this length (only one fixed length). See "Set Length 2" for more detailed programming instructions.



Select Code 128 Length 2 Setting

To configure this feature, scan the ENTER/EXIT bar code above, then the bar code at left followed by digits from the Alphanumeric characters in [Appendix D, Keypad](#) representing your desired character(s). End by scanning the ENTER/EXIT bar code again.

Make a mistake? Scan the CANCEL bar code to abort and not save the entry string. You can then start again at the beginning.



CANCEL

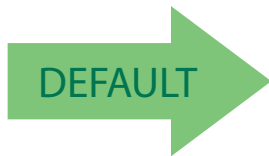

80 = Length 2 is 80 Characters

GS1-128

The following options apply to the GS1-128 symbology. (Also known as USS-128, GTIN-128, UCC-128.)

GS1-128 Enable

This option enables/disables the ability of the scanner to translate GS1-128 labels to the GS1-128 data format. Options are:

- Transmit GS1-128 labels in Code 128 data format.
- Transmit GS1-128 labels in GS1-128 data format.
- Do not transmit GS1-128 labels.

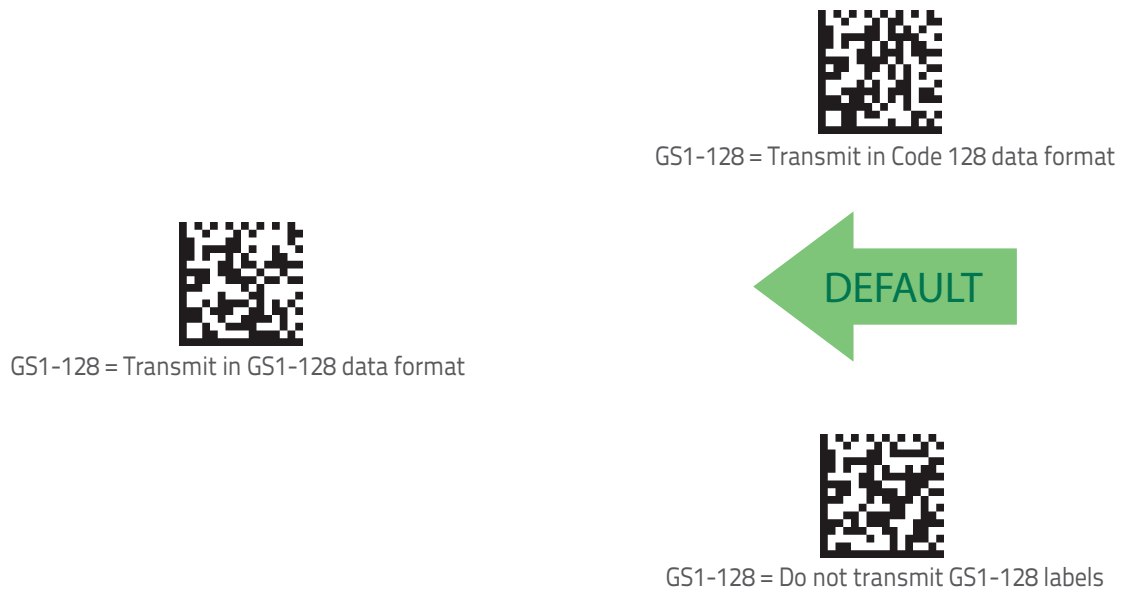

GS1-128 2D Component

This feature enables/disables a requirement that a 2D label component be decoded when a base label of this symbology is decoded.

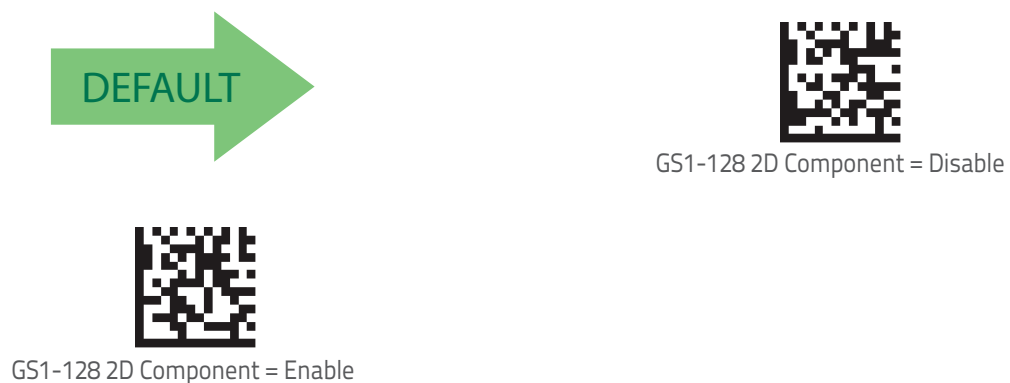



Interleaved 2 of 5 (I 2 of 5)

The following options apply to the I 2 of 5 symbology.



CAUTION

When reading this symbology, the settings for I 2 of 5 Length Control AND I 2 of 5 Check Character Calculation **MUST** be enabled to increase decoding safety.

I 2 of 5 Enable/Disable

When disabled, the scanner will not read I 2 of 5 bar codes.

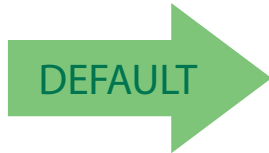

I 2 of 5 = Disable



I 2 of 5 = Enable

I 2 of 5 Check Character Calculation

This option enables/disables calculation and verification of an optional I 2 of 5 check character.

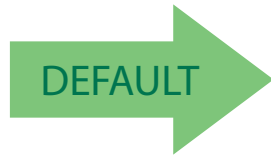

I 2 of 5 Check Char Calc = Disable



I 2 of 5 Check Char Calc = Check Standard
(Modulo 10)



I 2 of 5 Check Char Calc = Check German Parcel



I 2 of 5 Check Char Calc = Check DHL



I 2 of 5 Check Char Calc = Check Daimler Chrysler



I 2 of 5 Check Char Calc = Check Bosch



I 2 of 5 Check Character Calculation = Check Italian Post

When disabled, any check character in label is treated as a data character.



I 2 of 5 Check Character Transmission

Enable this option to transmit the check character along with I 2 of 5 bar code data.



NOTE

This feature is valid only when I 2 of 5 Check Character Calculation is enabled.



I 2 of 5 Check Character Transmission = Don't Send



I 2 of 5 Check Character Transmission = Send



I 2 of 5 Length Control

This feature specifies either variable length decoding or fixed length decoding for the I 2 of 5 symbology.

Variable Length: For variable length decoding, a minimum and maximum length may be set.

Fixed Length: For fixed length decoding, two different lengths may be set.

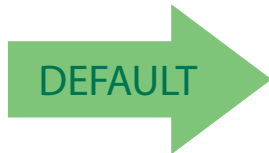

I 2 of 5 Length Control = Variable Length



I 2 of 5 Length Control = Fixed Length

I 2 of 5 Set Length 1

This feature specifies one of the bar code lengths for I 2 of 5 Length Control. Length 1 is the minimum label length if in **Variable Length Mode**, or the first fixed length if in **Fixed Length Mode**. The length includes the bar code's check and data characters.

The length can be set from 2 to 50 characters in increments of two. See "Set Length 1" for more detailed programming instructions.



Select I 2 of 5 Length 1 Setting

To configure this feature, scan the ENTER/EXIT bar code above, then the bar code at left followed by digits from the Alphanumeric characters in **Appendix D, Keypad** representing your desired character(s). End by scanning the ENTER/EXIT bar code again.

Make a mistake? Scan the CANCEL bar code to abort and not save the entry string. You can then start again at the beginning.



CANCEL

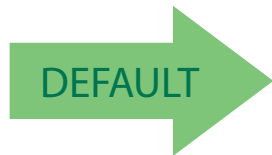

06 = Length 1 is 6 Characters



1 2 of 5 Set Length 2

This feature specifies one of the bar code lengths for 1 2 of 5 Length Control. Length 2 is the maximum label length if in Variable Length Mode, or the second fixed length if in Fixed Length Mode. The length includes the bar code's check and data characters.

The length can be set from 2 to 50 characters. A setting of 0 specifies to ignore this length (only one fixed length). See "Set Length 2" for more detailed programming instructions.



Select 1 2 of 5 Length 2 Setting

To configure this feature, scan the ENTER/EXIT bar code above, then the bar code at left followed by digits from the Alphanumeric characters in [Appendix D, Keypad](#) representing your desired character(s). End by scanning the ENTER/EXIT bar code again.

Make a mistake? Scan the CANCEL bar code to abort and not save the entry string. You can then start again at the beginning.



CANCEL



50 = Length 2 is 50 Characters

Interleaved 2 of 5 CIP HR

The following options apply to the Interleaved 2 of 5 CIP HR symbology.

Interleaved 2 of 5 CIP HR Enable/Disable

Enables/Disables ability of scanner to decode Interleaved 2 of 5 CIP HR labels.

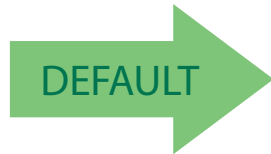

Interleaved 2 of 5 CIP HR = Disable



Interleaved 2 of 5 CIP HR = Enable



Matrix 2 of 5

Matrix 2 of 5 Enable/Disable

Enables/Disables ability of scanner to decode Matrix 2 of 5 labels.

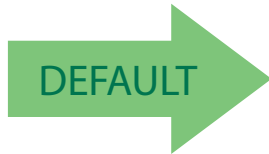

Matrix 2 of 5 = Disable



Matrix 2 of 5 = Enable

Matrix 2 of 5 Check Character Calculation

Enables/Disables calculation and verification of Matrix 2 of 5 check character.



Matrix 2 of 5 Check Character Calculation = Disable



Matrix 2 of 5 Check Character Calculation = Enable



Matrix 2 of 5 Check Character Transmission

Enables/Disables transmission of Matrix 2 of 5 check character.

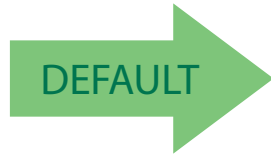

Matrix 2 of 5 Check Character Transmission = Disable



Matrix 2 of 5 Check Character Transmission = Enable

Matrix 2 of 5 Length Control

This feature specifies variable length decoding or fixed length decoding for the Matrix 2 of 5 symbology.

Variable Length: For variable length decoding, a minimum and maximum length may be set.

Fixed Length: For fixed length decoding, two different lengths may be set.

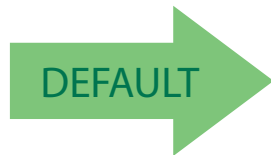

Matrix 2 of 5 Length Control = Variable length



Matrix 2 of 5 Length Control = Fixed length



Matrix 2 of 5 Set Length 1

This feature specifies one of the bar code lengths for Matrix 2 of 5 Length Control. Length 1 is the minimum label length if in Variable Length Mode, or the first fixed length if in Fixed Length Mode. Length includes the bar code's data characters only. Length can be set from 01 to 50 characters.

Table 4 provides some examples for setting Length 1.

Table 4. Matrix 2 of 5 Length 1 Setting Example

STEP	ACTION	EXAMPLES			
1	Desired Setting	01 Character	07 Characters	15 Characters	50 Characters
2	Scan ENTER/EXIT PROGRAMMING MODE				
3	Scan SELECT Matrix 2 of 5 LENGTH 1SETTING				
4	Scan Two Characters From Appendix D, Keypad	'0' and '1'	'0' and '7'	'1' and '5'	'5' AND '0'
5	Scan ENTER/EXIT PROGRAMMING MODE				



Matrix 2 of 5 Set Length 1 Setting

Make a mistake? Scan the CANCEL bar code to abort and not save the entry string. You can then start again at the beginning.



CANCEL



01 = Length 1 is 1 Character



Matrix 2 of 5 Set Length 2

This feature specifies one of the bar code lengths for Matrix 2 of 5 Length Control. Length 2 is the maximum label length if in Variable Length Mode, or the second fixed length if in Fixed Length Mode. Length includes the bar code's check, data, and full-ASCII shift characters. Length does not include start/stop characters. Length can be set from 1 to 50 characters. A setting of 0 specifies to ignore this length (only one fixed length).

Table 5 provides some examples for setting Length 2.

Table 5. Matrix 2 of 5 Length 2 Setting Example

STEP	ACTION	EXAMPLES			
1	Desired Setting	00 (Ignore This Length)	07 Characters	15 Characters	50 Characters
2	Scan ENTER/EXIT PROGRAMMING MODE				
3	Scan SELECT Matrix 2 of 5 LENGTH 1SETTING				
4	Scan Two Characters From Appendix D, Keypad	'0' and '0'	'0' and '7'	'1' and '5'	'5' AND '0'
5	Scan ENTER/EXIT PROGRAMMING MODE				



Matrix 2 of 5 Set Length 2 Setting

Make a mistake? Scan the CANCEL bar code to abort and not save the entry string. You can then start again at the beginning.



CANCEL



01 = Length 1 is 1 Character



Datalogic 2 of 5

The following options apply to the Datalogic 2 of 5 symbology.

Datalogic 2 of 5 Enable/Disable

When disabled, the scanner will not read Datalogic 2 of 5 bar codes.

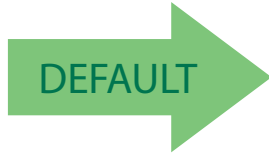

Datalogic 2 of 5 = Disable



Datalogic 2 of 5 = Enable

Datalogic 2 of 5 Check Character Calculation

This option enables/disables calculation and verification of an optional Datalogic 2 of 5 check character.

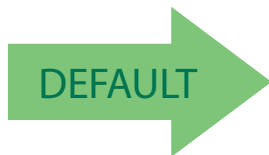

Datalogic 2 of 5 Check Character Calculation = Disable



Datalogic 2 of 5 Check Character Calculation = Enable

Datalogic 2 of 5 Check Character Transmission

This option enables/disables transmission of an optional Datalogic 2 of 5 character.



Datalogic 2 of 5 Check Character Transmission = Don't Send



Datalogic 2 of 5 Check Character Transmission = Send





Datalogic 2 of 5 Length Control

This feature specifies either variable length decoding or fixed length decoding for the Datalogic 2 of 5 symbology.

Variable Length: For variable length decoding, a minimum and maximum length may be set.

Fixed Length: For fixed length decoding, two different lengths may be set.

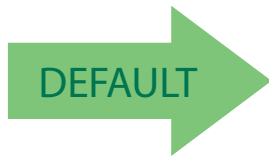

Datalogic 2 of 5 Length Control = Variable Length



Datalogic 2 of 5 Length Control = Fixed Length

Datalogic 2 of 5 Set Length 1

This feature specifies one of the bar code lengths for Datalogic 2 of 5 Length Control. Length 1 is the minimum label length if in Variable Length Mode, or the first fixed length if in Fixed Length Mode. The length includes the bar code's data characters only.

The length can be set from 2 to 50 characters in increments of two. See "Set Length 1" for more detailed programming instructions.



Select Datalogic 2 of 5 Length 1 Setting

To configure this feature, scan the ENTER/EXIT bar code above, then the bar code at left followed by digits from the Alphanumeric characters in **Appendix D, Keypad** representing your desired character(s). End by scanning the ENTER/EXIT bar code again.

Make a mistake? Scan the CANCEL bar code to abort and not save the entry string. You can then start again at the beginning.



CANCEL

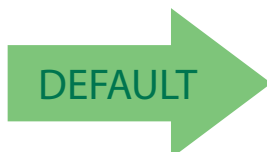

06 = Length 1 is 6 Characters

Datalogic 2 of 5 Set Length 2

This feature specifies one of the bar code lengths for Datalogic 2 of 5 Length Control. Length 2 is the maximum label length if in Variable Length Mode, or the second fixed length if in Fixed Length Mode. The length includes the bar code's data characters only.

The length can be set from 2 to 50 characters. A setting of 00 specifies to ignore this length (only one fixed length). See "Set Length 2" for more detailed programming instructions.



Select Datalogic 2 of 5 Length 2 Setting

To configure this feature, scan the ENTER/EXIT bar code above, then the bar code at left followed by digits from the Alphanumeric characters in [Appendix D, Keypad](#) representing your desired character(s). End by scanning the ENTER/EXIT bar code again.

Make a mistake? Scan the CANCEL bar code to abort and not save the entry string. You can then start again at the beginning.



CANCEL

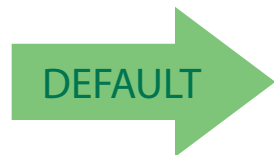

50 = Length 2 is 50 Characters



Compressed 2 of 5

Compressed 2 of 5 Enable/Disable

Enables/Disables ability of scanner to decode Compressed 2 of 5 labels.

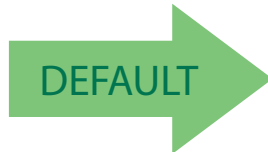

Compressed 2 of 5 = Disable



Compressed 2 of 5 = Enable

Compressed 2 of 5 Check Character Calculation

Enables/Disables calculation and verification of Compressed 2 of 5 check character.



Compressed 2 of 5 Check Character Calculation = Disable



Compressed 2 of 5 Check Character Calculation = Enable

Compressed 2 of 5 Check Character Transmission

Enables/disables transmission of optional Compressed 2 of 5 check character.

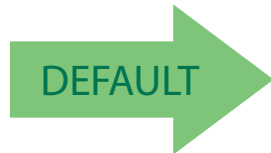

Compressed 2 of 5 Check Character Transmission = Disable



Compressed 2 of 5 Check Character Transmission = Enable

Compressed 2 of 5 Length Control

This feature specifies either variable length decoding or fixed length decoding for the Compressed 2 of 5 symbology.

Variable Length: For variable length decoding, a minimum and maximum length may be set.

Fixed Length: For fixed length decoding, two different lengths may be set.



Compressed 2 of 5 Length Control = Variable Length



Compressed 2 of 5 Length Control = Fixed Length



Compressed 2 of 5 Set Length 1

This feature specifies one of the bar code lengths for Compressed 2 of 5 Length Control. Length 1 is the minimum label length if in Variable Length Mode, or the first fixed length if in Fixed Length Mode. Length includes the bar code’s data characters only. The length can be set from 01 to 50 characters.

Table 6 provides some examples for setting Length 1.

Table 6. Compressed 2 of 5 Length 1 Setting Example

STEP	ACTION	EXAMPLES			
1	Desired Setting	01 Character	07 Characters	15 Characters	50 Characters
2	Scan ENTER/EXIT PROGRAMMING MODE				
3	Scan SELECT Compressed 2 of 5 LENGTH 1SETTING				
4	Scan Two Characters From Appendix D, Keypad	'0' and '1'	'0' and '7'	'1' and '5'	'5' AND '0'
5	Scan ENTER/EXIT PROGRAMMING MODE				



Select Compressed 2 of 5 Length 1 Setting

To configure this feature, scan the ENTER/EXIT bar code above, then the bar code at left followed by digits from the Alphanumeric characters in **Appendix D, Keypad** representing your desired character(s). End by scanning the ENTER/EXIT bar code again.

Make a mistake? Scan the CANCEL bar code to abort and not save the entry string. You can then start again at the beginning.



CANCEL



Compressed 2 of 5 Set Length 2

This feature specifies one of the bar code lengths for Compressed 2 of 5 Length Control. Length 2 is the maximum label length if in Variable Length Mode, or the second fixed length if in Fixed Length Mode. Length includes the bar code’s check, data, and full-ASCII shift characters. The length does not include start/stop characters. The length can be set from 1 to 50 characters. A setting of 0 specifies to ignore this length (only one fixed length).

Table 7 provides some examples for setting Length 1.

Table 7. Compressed 2 of 5 Length 1 Setting Example

STEP	ACTION	EXAMPLES			
1	Desired Setting	01 Character	07 Characters	15 Characters	50 Characters
2	Scan ENTER/EXIT PROGRAMMING MODE				
3	Scan SELECT Compressed 2 of 5 LENGTH 1 SETTING				
4	Scan Two Characters From Appendix D, Keypad	'0' and '1'	'0' and '7'	'1' and '5'	'5' AND '0'
5	Scan ENTER/EXIT PROGRAMMING MODE				



Select Compressed 2 of 5 Length 2 Setting

To configure this feature, scan the ENTER/EXIT bar code above, then the bar code at left followed by digits from the Alphanumeric characters in **Appendix D, Keypad** representing your desired character(s). End by scanning the ENTER/EXIT bar code again.

Make a mistake? Scan the CANCEL bar code to abort and not save the entry string. You can then start again at the beginning.



CANCEL



Codabar

The following options apply to the Codabar symbology.

Codabar Enable/Disable

When disabled, the scanner will not read Codabar bar codes.

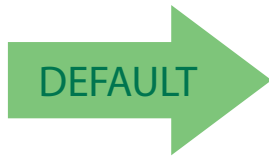

Codabar = Disable



Codabar = Enable

Codabar Check Character Calculation

Enable this option to enable/disable calculation and verification of an optional Codabar check character. When disabled, any check characters in the label are treated as data characters.

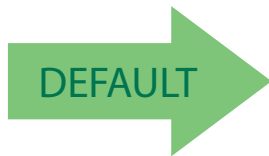

Codabar Check Character Calculation = Don't Calculate



Codabar Check Character Calculation = Enable AIM standard check char.



Codabar Check Character Calculation = Enable Modulo 10 check char.



Codabar Check Character Calculation = Enable NW-7

Codabar Check Character Transmission

Enable this option to transmit the check character along with Codabar bar code data.



NOTE

This feature is valid only when Codabar Check Character Calculation is enabled.



Codabar Check Character Transmission = Don't Send



Codabar Check Character Transmission = Send





Codabar Start/Stop Character Transmission

Enable this option to enable/disable transmission of Codabar start and stop characters.



Codabar Start/Stop Character Transmission = Don't Transmit



Codabar Start/Stop Character Transmission = Transmit



Codabar Start/Stop Character Set

This option specifies the format of transmitted Codabar start/stop characters.



Codabar Check Character Set = ABCD/TN*E



Codabar Check Character Set = ABCD/ABCD



Codabar Check Character Set = abcd/tn*e



Codabar Check Character Set = abcd/abcd



Codabar Start/Stop Character Match

When enabled, this option requires that start and stop characters match.

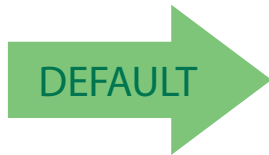

Codabar Start/Stop Character Match = Don't Require Match



Codabar Start/Stop Character Match = Require Match



Codabar Quiet Zones

This feature specifies the number of quiet zones for Codabar labels. Quiet zones are blank areas at the ends of a bar code and are typically 10 times the width of the narrowest bar or space in the label.



Codabar Quiet Zones = Quiet Zone on one side

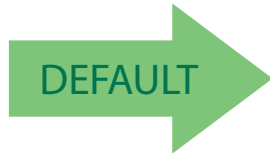

Codabar Quiet Zones = Quiet Zones on two sides



Codabar Quiet Zones = Auto



Codabar Quiet Zones = Virtual Quiet Zone on two sides



Codabar Quiet Zones = Small Quiet Zone on two sides



Codabar Length Control

This feature specifies either variable length decoding or fixed length decoding for the Codabar symbology.

Variable Length: For variable length decoding, a minimum and maximum length may be set.

Fixed Length: For fixed length decoding, two different lengths may be set.

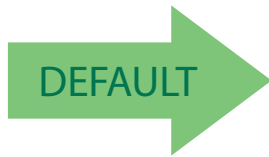

Codabar Length Control = Variable Length



Codabar Length Control = Fixed Length

Codabar Set Length 1

This feature specifies one of the bar code lengths for **Codabar Length Control**. Length 1 is the minimum label length if in **Variable Length Mode**, or the first fixed length if in **Fixed Length Mode**. Length includes the bar code's start, stop, check and data characters. The length must include at least one data character.

The length can be set from 3 to 50 characters. See "**Set Length 1**" for more detailed programming instructions.



Select Codabar Length 1 Setting

To configure this feature, scan the ENTER/EXIT bar code above, then the bar code at left followed by digits from the Alphanumeric characters in **Appendix D, Keypad** representing your desired character(s). End by scanning the ENTER/EXIT bar code again.

Make a mistake? Scan the CANCEL bar code to abort and not save the entry string. You can then start again at the beginning.



CANCEL

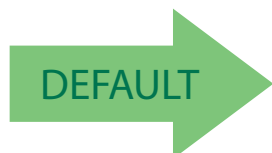

03 = Length 1 is 3 Characters



Codabar Set Length 2

This feature specifies one of the bar code lengths for **Codabar Length Control**. Length 2 is the maximum label length if in **Variable Length Mode**, or the second fixed length if in **Fixed Length Mode**. The length includes the bar code's start, stop, check and data characters. The length must include at least one data character.

The length can be set from 3 to 50 characters. A setting of 00 specifies to ignore this length (only one fixed length). See "**Set Length 2**" for more detailed programming instructions.



Select Codabar Length 2 Setting

To configure this feature, scan the ENTER/EXIT bar code above, then the bar code at left followed by digits from the Alphanumeric characters in **Appendix D, Keypad** representing your desired character(s). End by scanning the ENTER/EXIT bar code again.

Make a mistake? Scan the CANCEL bar code to abort and not save the entry string. You can then start again at the beginning.



CANCEL

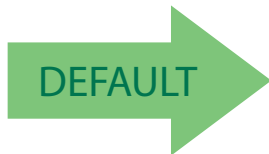

50 = Length 2 is 50 Characters

ABC Codabar

The following options apply to the ABC Codabar symbology.

ABC Codabar Enable/Disable

Enables/Disables ability of scanner to decode ABC Codabar labels.

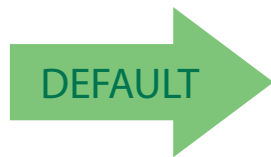

ABC Codabar = Disable



ABC Codabar = Enable

ABC Codabar Concatenation Mode

Specifies the concatenation mode between Static and Dynamic.

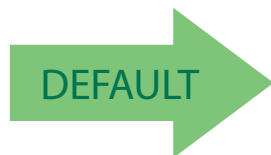

ABC Codabar Concatenation Mode = Static



ABC Codabar Concatenation Mode = Dynamic



ABC Codabar Dynamic Concatenation Timeout

This parameter specifies the timeout in 10–millisecond ticks used by the ABC Codabar Dynamic Concatenation Mode. The timeout can be set within a range of 05 to 255 in 10ms increments. A setting of zero specifies no delay.



Select ABC Codabar Dynamic Concatenation Timeout Setting

To configure this feature, scan the ENTER/EXIT bar code above, then the bar code at left followed by digits from the Alphanumeric characters in [Appendix D, Keypad](#) representing your desired character(s). End by scanning the ENTER/EXIT bar code again.

Make a mistake? Scan the CANCEL bar code to abort and not save the entry string. You can then start again at the beginning.



CANCEL

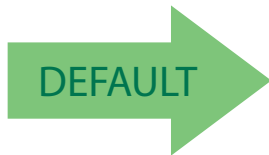

Default Quiet Interval = 20 ms

ABC Codabar Force Concatenation

When ABC Codabar Concatenation is enabled and Force Concatenation is disabled, both Codabar stand alone labels and ABC Codabar concatenated labels are transmitted. When ABC Codabar Concatenation is enabled and Force Concatenation is enabled only ABC Codabar concatenated labels are transmitted while Codabar stand alone labels are not transmitted.

Force Concatenation has no effect if the ABC Codabar Concatenation is disabled. The Force Concatenation mode has effect both in Static and Dynamic Concatenation Modes.

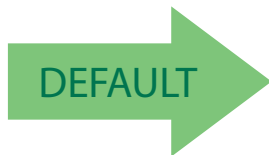

ABC Codabar Force Concatenation = Disable



ABC Codabar Force Concatenation = Enable

Code 11

The following options apply to the Code 11 symbology.

Code 11 Enable/Disable

When disabled, the scanner will not read Code 11 bar codes.

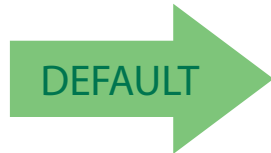

Code 11 = Disable



Code 11 = Enable

Code 11 Check Character Calculation

This option enables/disables calculation and verification of optional Code 11 check character.



Code 11 Check Character Calculation = Disable



Code 11 Check Character Calculation = Check C



Code 11 Check Character Calculation = Check K



Code 11 Check Character Calculation = Check C and K





Code 11 Check Character Transmission

This feature enables/disables transmission of an optional Code 11 check character.



Code 11 Check Character Transmission = Don't Send



Code 11 Check Character Transmission = Send



Code 11 Length Control

This feature specifies either variable length decoding or fixed length decoding for the Code 11 symbology.

Variable Length: For variable length decoding, a minimum and maximum length may be set.

Fixed Length: For fixed length decoding, two different lengths may be set.



Code 11 Length Control = Variable Length



Code 11 Length Control = Fixed Length

Code 11 Set Length 1

This feature specifies one of the bar code lengths for Code 11 Length Control. Length 1 is the minimum label length if in **Variable Length Mode**, or the first fixed length if in **Fixed Length Mode**. Length includes the bar code's check and data characters.

The length can be set from 2 to 50 characters. See "Set Length 1" for more detailed programming instructions.



Select Code 11 Set Length 1 Setting

To configure this feature, scan the ENTER/EXIT bar code above, then the bar code at left followed by digits from the Alphanumeric characters in **Appendix D, Keypad** representing your desired character(s). End by scanning the ENTER/EXIT bar code again.

Make a mistake? Scan the CANCEL bar code to abort and not save the entry string. You can then start again at the beginning.



CANCEL

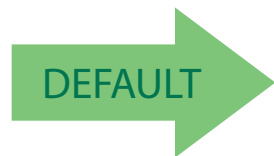

04 = Length 1 is 4 Characters



Code 11 Set Length 2

This feature specifies one of the bar code lengths for Code 11 Length Control. Length 2 is the maximum label length if in Variable Length Mode, or the second fixed length if in Fixed Length Mode. Length includes the bar code's check and data characters.

The length can be set from 2 to 50 characters. A setting of 00 specifies to ignore this length (only one fixed length). See "Set Length 2" for more detailed programming instructions.



Select Code 11 Length 2 Setting

To configure this feature, scan the ENTER/EXIT bar code above, then the bar code at left followed by digits from the Alphanumeric characters in [Appendix D, Keypad](#) representing your desired character(s). End by scanning the ENTER/EXIT bar code again.

Make a mistake? Scan the CANCEL bar code to abort and not save the entry string. You can then start again at the beginning.



CANCEL

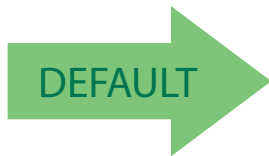

50 = Length 2 is 50 Characters

Standard 2 of 5

The following options apply to the Standard 2 of 5 symbology.

Standard 2 of 5 Enable/Disable

When disabled, the scanner will not read Standard 2 of 5 bar codes.

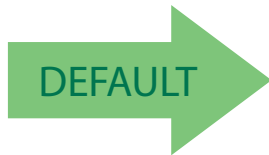

Standard 2 of 5 = Disable



Standard 2 of 5 = Enable

Standard 2 of 5 Check Character Calculation

This option enables/disables calculation and verification of an optional Standard 2 of 5 check character.

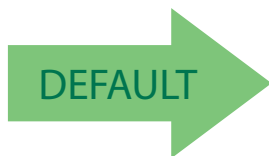

Standard 2 of 5 Check Character Calculation = Disable



Standard 2 of 5 Check Character Calculation = Enable



Standard 2 of 5 Check Character Transmission

This feature enables/disables transmission of an optional Standard 2 of 5 check character.



Standard 2 of 5 Check Character Transmission = Don't Send



Standard 2 of 5 Check Character Transmission = Send



Standard 2 of 5 Length Control

This feature specifies either variable length decoding or fixed length decoding for the Standard 2 of 5 symbology.

Variable Length: For variable length decoding, a minimum and maximum length may be set.

Fixed Length: For fixed length decoding, two different lengths may be set.

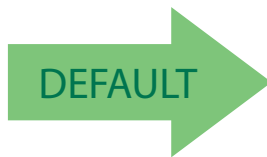

Standard 2 of 5 Length Control = Variable Length



Standard 2 of 5 Length Control = Fixed Length

Standard 2 of 5 Set Length 1

This feature specifies one of the bar code lengths for Standard 2 of 5 Length Control. Length 1 is the minimum label length if in Variable Length Mode, or the first fixed length if in Fixed Length Mode. Length includes the bar code's check and data characters.

The length can be set from 1 to 50 characters. See "Set Length 1" for more detailed programming instructions.



Select Standard 2 of 5 Length 1 Setting

To configure this feature, scan the ENTER/EXIT bar code above, then the bar code at left followed by digits from the Alphanumeric characters in [Appendix D, Keypad](#) representing your desired character(s). End by scanning the ENTER/EXIT bar code again.

Make a mistake? Scan the CANCEL bar code to abort and not save the entry string. You can then start again at the beginning.



CANCEL

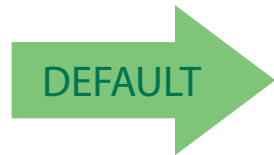

08 = Length 1 is 8 Characters



Standard 2 of 5 Set Length 2

This feature specifies one of the bar code lengths for Standard 2 of 5 Length Control. Length 2 is the maximum label length if in Variable Length Mode, or the second fixed length if in Fixed Length Mode. Length includes the bar code's check and data characters.

The length can be set from 1 to 50 characters. A setting of 00 specifies to ignore this length (only one fixed length). See "Set Length 2" for more detailed programming instructions.



Select Standard 2 of 5 Length 2 Setting

To configure this feature, scan the ENTER/EXIT bar code above, then the bar code at left followed by digits from the Alphanumeric characters in **Appendix D, Keypad** representing your desired character(s). End by scanning the ENTER/EXIT bar code again.

Make a mistake? Scan the CANCEL bar code to abort and not save the entry string. You can then start again at the beginning.



CANCEL

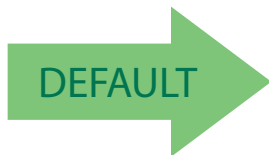

50 = Length 2 is 50 Characters

Industrial 2 of 5

The following options apply to the Industrial 2 of 5 symbology.

Industrial 2 of 5 Enable/Disable

Enables/Disables ability of scanner to decode Industrial 2 of 5 labels.

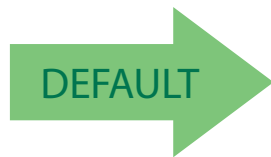

Industrial 2 of 5 = Disable



Industrial 2 of 5 = Enable

Industrial 2 of 5 Check Character Calculation

Enables/Disables calculation and verification of an optional Industrial 2 of 5 check character.

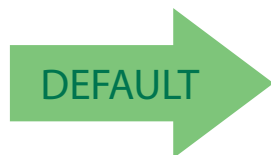

Industrial 2 of 5 Check Character Calculation = Disable



Industrial 2 of 5 Check Character Calculation = Enable



Industrial 2 of 5 Check Character Transmission

Enables/disables transmission of an Industrial 2 of 5 check character.



Industrial 2 of 5 Check Character Transmission = Disable



Industrial 2 of 5 Check Character Transmission = Enable



Industrial 2 of 5 Length Control

This feature specifies either variable length decoding or fixed length decoding for the Industrial 2 of 5 symbology.

Variable Length: For variable length decoding, a minimum and maximum length may be set.

Fixed Length: For fixed length decoding, two different lengths may be set.

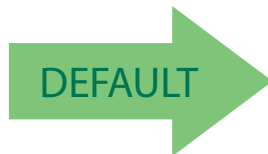

Industrial 2 of 5 Length Control = Variable Length



Industrial 2 of 5 = Fixed Length

Industrial 2 of 5 Set Length 1

This feature specifies one of the bar code lengths for Industrial 2 of 5 Length Control. Length 1 is the minimum label length if in **Variable Length Mode**, or the first fixed length if in **Fixed Length Mode**. Length includes the bar code's data characters only.

The length can be set from 1 to 50 characters. See "**Set Length 1**" for more detailed programming instructions.



Select Industrial 2 of 5 Set Length 1 Setting

To configure this feature, scan the ENTER/EXIT bar code above, then the bar code at left followed by digits from the Alphanumeric characters in **Appendix D, Keypad** representing your desired character(s). End by scanning the ENTER/EXIT bar code again.

Make a mistake? Scan the CANCEL bar code to abort and not save the entry string. You can then start again at the beginning.



CANCEL



Default value is 6



Industrial 2 of 5 Set Length 2

This feature specifies one of the bar code lengths for Industrial 2 of 5 Length Control. Length 2 is the maximum label length if in Variable Length Mode, or the second fixed length if in Fixed Length Mode. Length includes the bar code's check, data, and full-ASCII shift characters. The length does not include start/stop characters.

The length can be set from 1 to 50 characters. A setting of 00 specifies to ignore this length (only one fixed length). See "Set Length 2" for more detailed programming instructions.



Select Industrial 2 of 5 Length 2 Setting

To configure this feature, scan the ENTER/EXIT bar code above, then the bar code at left followed by digits from the Alphanumeric characters in [Appendix D, Keypad](#) representing your desired character(s). End by scanning the ENTER/EXIT bar code again.

Make a mistake? Scan the CANCEL bar code to abort and not save the entry string. You can then start again at the beginning.



CANCEL

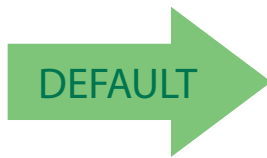

50 = Length 2 is 50 Characters

IATA

The following options apply to the IATA symbology.

IATA Enable/Disable

Enables/Disables the ability of the scanner to decode IATA labels.

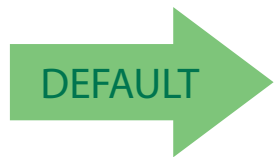

IATA = Disable



IATA = Enable

IATA Check Character Transmission

Enables/Disables calculation and verification of an optional Industrial 2 of 5 check character.



IATA Check Character Transmission = Disable



IATA Check Character Transmission = Enable





ISBT 128

The following options apply to the ISBT 128 symbology.

ISBT 128 Concatenation

Enables/disables ISBT128 concatenation of 2 labels.

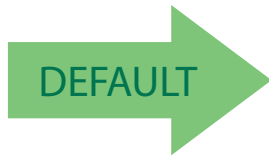

ISBT 128 Concatenation = Disable



ISBT 128 Concatenation = Enable

ISBT 128 Concatenation Mode

Specifies the concatenation mode between Static and Dynamic.



NOTE

This option is only valid when ISBT 128 Concatenation is enabled.

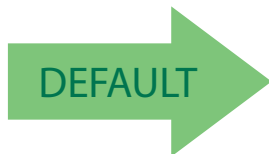

ISBT 128 Concatenation Mode = Static



ISBT 128 Concatenation Mode = Dynamic

ISBT 128 Dynamic Concatenation Timeout

Specifies the timeout used by the ISBT 128 Dynamic Concatenation Mode.



ISBT 128 Dynamic Concatenation Timeout = 50 msec



ISBT 128 Dynamic Concatenation Timeout = 100 msec

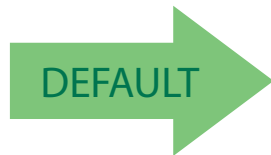

ISBT 128 Dynamic Concatenation Timeout = 200 msec



ISBT 128 Dynamic Concatenation Timeout = 500 msec



ISBT 128 Dynamic Concatenation Timeout = 750 msec



ISBT 128 Dynamic Concatenation Timeout = 1 second



ISBT 128 Force Concatenation

When enabled, this feature forces all ISBT 128 labels to be concatenated.



NOTE

This option is only valid when ISBT 128 Concatenation is enabled.

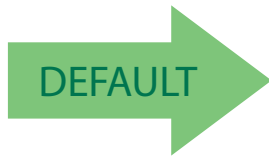

ISBT 128 Force Concatenation = Disable



ISBT 128 Force Concatenation = Enable

ISBT 128 Advanced Concatenation Options



NOTE

Contact Customer Support to set up pairs of label types for concatenation.

MSI

The following options apply to the MSI symbology.

MSI Enable/Disable

Enables/Disables ability of scanner to decode MSI labels.



MSI Check Character Calculation

Enables/Disables calculation and verification of an optional MSI check character.

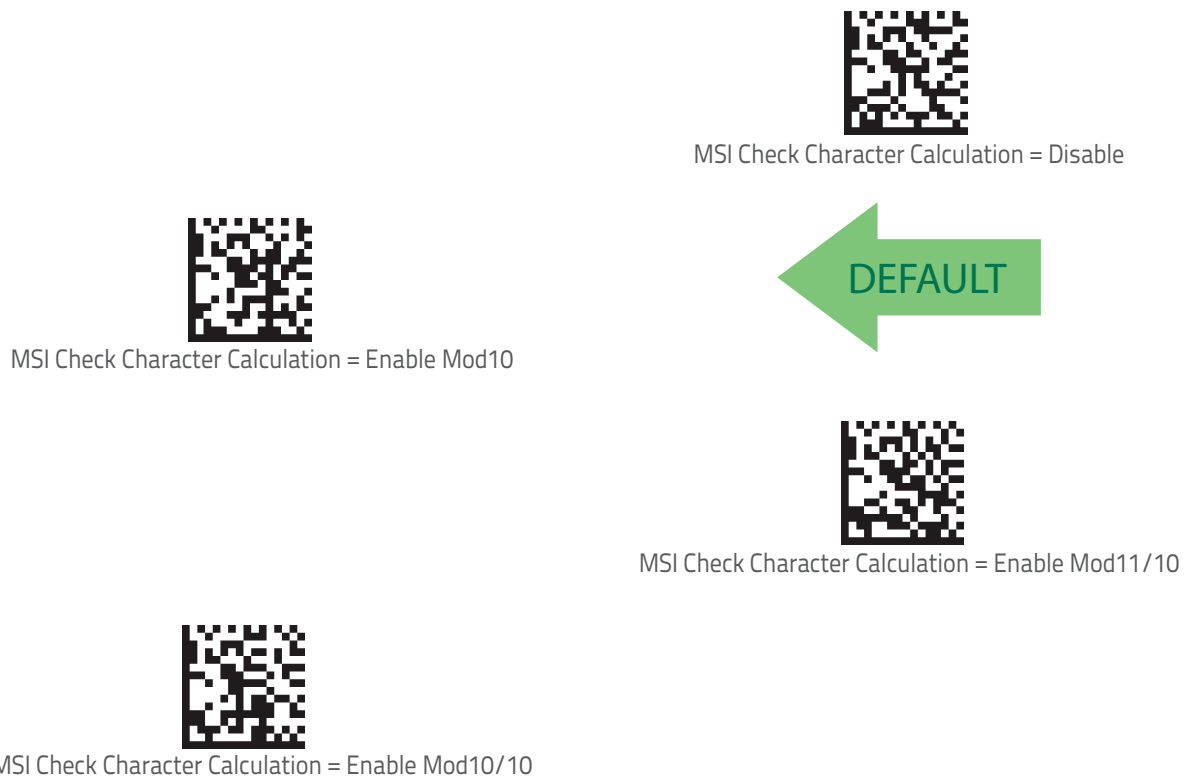



MSI Check Character Transmission

Enables/disables transmission of an MSI check character.



MSI Check Character Transmission = Disable



MSI Check Character Transmission = Enable



MSI Length Control

This feature specifies either variable length decoding or fixed length decoding for the MSI symbology.

Variable Length: For variable length decoding, a minimum and maximum length may be set.

Fixed Length: For fixed length decoding, two different lengths may be set.

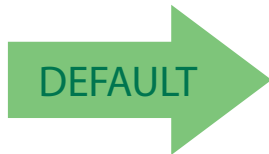

MSI Length Control = Variable Length



MSI = Fixed Length

MSI Set Length 1

This feature specifies one of the bar code lengths for MSI Length Control. Length 1 is the minimum label length if in **Variable Length Mode**, or the first fixed length if in **Fixed Length Mode**. Length includes the bar code's data characters only.

The length can be set from 01 to 50 characters. See "Set Length 1" for more detailed programming instructions.



Select MSI Set Length 1 Setting

To configure this feature, scan the ENTER/EXIT bar code above, then the bar code at left followed by digits from the Alphanumeric characters in **Appendix D, Keypad** representing your desired character(s). End by scanning the ENTER/EXIT bar code again.

Make a mistake? Scan the CANCEL bar code to abort and not save the entry string. You can then start again at the beginning.



CANCEL

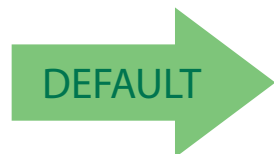

01 = Length 1 is 1 Character



MSI Set Length 2

This feature specifies one of the bar code lengths for MSI Length Control. Length 2 is the maximum label length if in **Variable Length Mode**, or the second fixed length if in **Fixed Length Mode**. Length includes the bar code's check, data, and full-ASCII shift characters. The length does not include start/stop characters.

The length can be set from 1 to 50 characters. A setting of 0 specifies to ignore this length (only one fixed length). See "Set Length 2" for more detailed programming instructions.



Select MSI Length 2 Setting

To configure this feature, scan the ENTER/EXIT bar code above, then the bar code at left followed by digits from the Alphanumeric characters in **Appendix D, Keypad** representing your desired character(s). End by scanning the ENTER/EXIT bar code again.

Make a mistake? Scan the CANCEL bar code to abort and not save the entry string. You can then start again at the beginning.



CANCEL

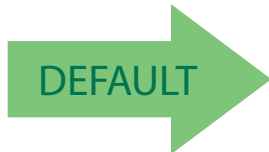

50 = Length 2 is 50 Characters



PLESSEY

The following options apply to the Plessey symbology.

Plessey Enable/Disable

Enables/Disables ability of scanner to decode Plessey labels.

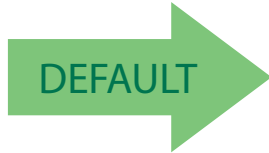

Plessey = Disable



Plessey = Enable



Plessey Check Character Calculation

Enables/Disables calculation and verification of Plessey check character.



Plessey Check Character Calculation = Disable



Plessey Check Character Calculation =
Enable Plessey std. check char. verification



Plessey Check Character Calculation =
Enable Anker check char. verification



Plessey Check Character Calculation =
Enable Plessey std. and Anker check char. verification

Plessey Check Character Transmission

Enables/Disables transmission of a Plessey check character.



Plessey Check Character Transmission = Disable



Plessey Check Character Transmission = Enable

Plessey Length Control

This feature specifies variable length decoding or fixed length decoding for the Plessey symbology.

Variable Length: For variable length decoding, a minimum and maximum length may be set.

Fixed Length: For fixed length decoding, two different lengths may be set.

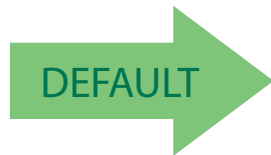

Plessey Length Control = Variable length



Plessey Length Control = Fixed length



Plessey Set Length 1

This feature specifies one of the bar code lengths for Plessey Length Control. Length 1 is the minimum label length if in Variable Length Mode, or the first fixed length if in Fixed Length Mode. Length includes the bar code's data characters only. Length can be set from 01 to 50 characters.

Table 8 provides some examples for setting Length 1.

Table 8. Plessey Length 1 Setting Example

STEP	ACTION	EXAMPLES			
1	Desired Setting	01 Character	07 Characters	15 Characters	50 Characters
2	Scan ENTER/EXIT PROGRAMMING MODE				
3	Scan SELECT Plessey LENGTH 1SETTING				
4	Scan Two Characters From Appendix D, Keypad	'0' and '1'	'0' and '7'	'1' and '5'	'5' AND '0'
5	Scan ENTER/EXIT PROGRAMMING MODE				



Plessey Set Length 1 Setting

Make a mistake? Scan the CANCEL bar code to abort and not save the entry string. You can then start again at the beginning.



CANCEL

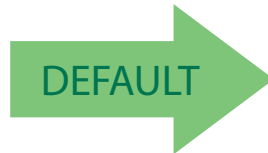

01 = Length 1 is 1 Character



Plessey Set Length 2

This feature specifies one of the bar code lengths for Plessey Length Control. Length 2 is the maximum label length if in Variable Length Mode, or the second fixed length if in Fixed Length Mode. Length includes the bar code’s check, data, and full-ASCII shift characters. Length does not include start/stop characters. Length can be set from 1 to 50 characters. A setting of 0 specifies to ignore this length (only one fixed length).

Table 9 provides some examples for setting Length 2.

Table 9. Plessey Length 2 Setting Example

STEP	ACTION	EXAMPLES			
1	Desired Setting	00 (Ignore This Length)	07 Characters	15 Characters	50 Characters
2	Scan ENTER/EXIT PROGRAMMING MODE				
3	Scan SELECT Plessey LENGTH 1SETTING				
4	Scan Two Characters From Appendix D, Keypad	'0' and '0'	'0' and '7'	'1' and '5'	'5' AND '0'
5	Scan ENTER/EXIT PROGRAMMING MODE				



Plessey Set Length 2 Setting

Make a mistake? Scan the CANCEL bar code to abort and not save the entry string. You can then start again at the beginning.



CANCEL

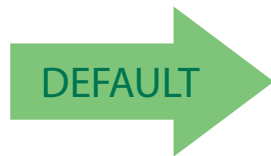

50 = Length 2 is 50 Characters



Code 93

The following options apply to the Code 93 symbology.

Code 93 Enable/Disable

Enables/Disables ability of scanner to decode Code 93 labels.

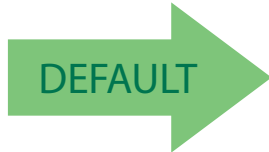

Code 93 = Disable



Code 93 = Enable

Code 93 Check Character Calculation

Enables/disables calculation and verification of an optional Code 93 check character.



Code 93 Check Character Calculation = Disable



Code 93 Check Character Calculation = Enable Check C



Code 93 Check Character Calculation = Enable Check K



Code 93 Check Character Calculation = Enable Check C and K



Code 93 Check Character Transmission

Enables/disables transmission of an optional Code 93 check character.

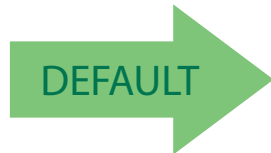

Code 93 Check Character Transmission = Disable



Code 93 Check Character Transmission = Enable

Code 93 Length Control

This feature specifies either variable length decoding or fixed length decoding for the Code 93 symbology.

Variable Length: For variable length decoding, a minimum and maximum length may be set.

Fixed Length: For fixed length decoding, two different lengths may be set.

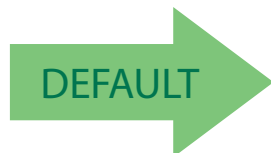

Code 93 Length Control = Variable Length



Code 93 = Fixed Length



Code 93 Set Length 1

This feature specifies one of the bar code lengths for Code 93 Length Control. Length 1 is the minimum label length if in Variable Length Mode, or the first fixed length if in Fixed Length. Length includes the bar code's data characters only.

The length can be set from 01 to 50 characters. See "Set Length 1" for more detailed programming instructions.



Select Code 93 Set Length 1 Setting

To configure this feature, scan the ENTER/EXIT bar code above, then the bar code at left followed by digits from the Alphanumeric characters in [Appendix D, Keypad](#) representing your desired character(s). End by scanning the ENTER/EXIT bar code again.

Make a mistake? Scan the CANCEL bar code to abort and not save the entry string. You can then start again at the beginning.



CANCEL

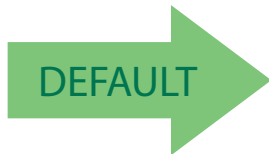

01 = Length 1 is 1 Character

Code 93 Set Length 2

This feature specifies one of the bar code lengths for Code 93 Length Control Length 2 is the maximum label length if in **Variable Length Mode**, or the second fixed length if in **Fixed Length Mode**. Length includes the bar code's check, data, and full-ASCII shift characters. The length does not include start/stop characters.

The length can be set from 1 to 50 characters. A setting of 00 specifies to ignore this length (only one fixed length). See "Set Length 2" for more detailed programming instructions.



Select Code 93 Length 2 Setting

To configure this feature, scan the ENTER/EXIT bar code above, then the bar code at left followed by digits from the Alphanumeric characters in **Appendix D, Keypad** representing your desired character(s). End by scanning the ENTER/EXIT bar code again.

Make a mistake? Scan the CANCEL bar code to abort and not save the entry string. You can then start again at the beginning.



CANCEL



50 = Length 2 is 50 Characters



Code 93 Quiet Zones

Enables/disables fixed length stitching for Code 93.



NOTE

This feature is available only on the TD1130 model.



Code 93 Quiet Zones = No Quiet Zones



Code 93 Quiet Zones = Quiet Zone on one side



Code 93 Quiet Zones = Quiet Zones on two sides



Code 93 Quiet Zones = Auto



Code 93 Quiet Zones = Virtual Quiet Zones on two sides

Follett 2 of 5

The following options apply to the Follett 2 of 5 symbology.

Follett 2 of 5 Enable/Disable

Enables/Disables ability of scanner to decode Follett 2 of 5 labels.

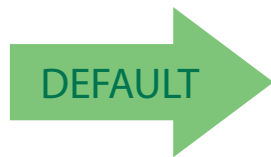

Follett 2 of 5 = Disable



Follett 2 of 5 = Enable

BC412

The following options apply to the BC412 symbology.

BC412 Enable/Disable

Enables/Disables ability of scanner to decode BC412 labels.

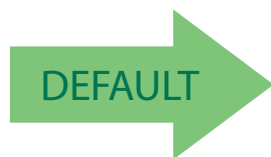

BC412 = Disable



BC412 = Enable



BC412 Check Character Calculation

Enable this option to enable/disable calculation and verification of an optional BC412 check character. When disabled, any check character in the label is treated as a data character.



BC412 Check Character Calculation = Don't Calculate



BC412 Check Character Calculation = Calculate Check Character



BC412 Check Character Transmission

Enables/disables transmission of an optional BC412 check character..



BC412 Check Character Transmission = Disable



BC412 Check Character Transmission = Enable



BC412 Length Control

This feature specifies either variable length decoding or fixed length decoding for the BC412 symbology.

Variable Length: For variable length decoding, a minimum and maximum length may be set.

Fixed Length: For fixed length decoding, two different lengths may be set.

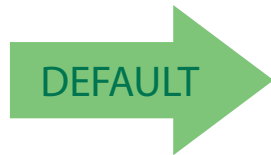

BC412 Length Control = Variable Length



BC412 Length Control = Fixed Length



BC412 Set Length 1

This feature specifies one of the bar code lengths for BC412 Length Control. Length 1 is the minimum label length if in Variable Length Mode, or the first fixed length if in Fixed Length Mode. Length includes the bar code's data characters only.

The length can be set from 01 to 50 characters. See "Set Length 1" for more detailed programming instructions.



Select BC412 Set Length 1 Setting

To configure this feature, scan the ENTER/EXIT bar code above, then the bar code at left followed by digits from the Alphanumeric characters in [Appendix D, Keypad](#) representing your desired character(s). End by scanning the ENTER/EXIT bar code again.

Make a mistake? Scan the CANCEL bar code to abort and not save the entry string. You can then start again at the beginning.



CANCEL

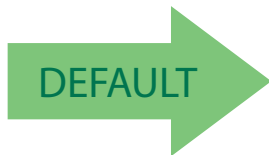

01 = Length 1 is 1 Character

BC412 Set Length 2

This feature specifies one of the bar code lengths for BC412 Length Control. Length 2 is the maximum label length if in **Variable Length Mode**, or the second fixed length if in **Fixed Length Mode**. Length includes the bar code's check, data, and full-ASCII shift characters. The length does not include start/stop characters.

The length can be set from 1 to 50 characters. A setting of 00 specifies to ignore this length (only one fixed length). See "Set Length 2" for more detailed programming instructions.



Select BC412 Length 2 Setting

To configure this feature, scan the ENTER/EXIT bar code above, then the bar code at left followed by digits from the Alphanumeric characters in **Appendix D, Keypad** representing your desired character(s). End by scanning the ENTER/EXIT bar code again.

Make a mistake? Scan the CANCEL bar code to abort and not save the entry string. You can then start again at the beginning.



CANCEL

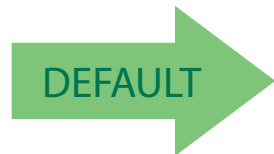

50 = Length 2 is 50 Characters

NOTES

2D Symbologies

2D Global Features	
▪ 2D MAXIMUM DECODING TIME	▪ 2D NORMAL/INVERSE SYMBOL CONTROL
▪ 2D STRUCTURED APPEND	

The reader supports the following 2D symbologies (bar code types). Symbology-dependent options for each symbology are included in this chapter. See "1D Symbologies" for configuration of 1D bar codes.

2D Symbologies	
▪ AZTEC CODE	▪ MICRO PDF417
▪ CHINA SENSIBLE CODE	▪ QR CODE
▪ DATA MATRIX	▪ MICRO QR CODE
▪ GS1 DotCODE	▪ UCC COMPOSITE
▪ PDF417	▪ POSTAL CODE SELECTION

2D Global Features

The following features are common to all, or in some cases, most of the available 2D symbologies. Default settings are indicated at each feature/option with a green arrow. Also reference [Appendix B, Standard Defaults](#) for a listing of the most widely used set of standard factory settings. That section also provides space to record any custom settings needed or implemented for your system.

To set most features:

1. Scan the ENTER/EXIT PROGRAMMING bar code at the top of applicable programming pages.
2. Scan the correct bar code to set the desired programming feature or parameter. You may need to cover unused bar codes on the page, and possibly the facing page, to ensure that the reader reads only the bar code you intend to scan.
3. If additional input parameters are needed, go to [Appendix D, Keypad](#), and scan the appropriate characters from the keypad.



NOTE

Additional information about many features can be found in the "References" chapter.

If you make a mistake before the last character, scan the CANCEL bar code to abort and not save the entry string. You can then start again at the beginning.

Complete the programming sequence by scanning the ENTER/EXIT PROGRAMMING bar code to exit Programming Mode.



2D Maximum Decoding Time

This feature specifies the maximum amount of time the software will spend attempting to decode a 2D label. The selectable range is 10 milliseconds to 2.55 milliseconds.



2D Maximum Decoding Time = 100 msec



2D Maximum Decoding Time = 200 msec



2D Maximum Decoding Time = 350 msec



2D Maximum Decoding Time = 500 msec



2D Maximum Decoding Time = 1 Second



2D Maximum Decoding Time = 2 Seconds



2D Maximum Decoding Time = 2.55 Seconds

2D Structured Append

Enables/disables ability of reader to append multiple 2D Codes labels in a structured format. The structured append property is globally applied to the following symbologies, if these are enabled:

- Data Matrix
- QR Code
- Aztec
- PDF 417

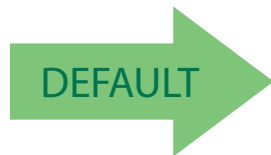

Structured Append = Disable



Structured Append = Enable

2D Normal/Inverse Symbol Control

Specifies the options available for decoding normal/negative printed 2D symbols. This configuration item applies globally to all the 2D symbologies that support that feature according to Standard AIM Specification: Data Matrix, QR, MicroQR, Aztec and Chinese Sensible Code.

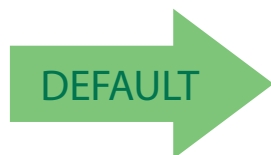

Normal/Inverse Symbol Control = Normal



Normal/Inverse Symbol Control = Inverse



Normal/Inverse Symbol Control =
Both Normal and Inverse



Symbology Selection

Aztec Code

Aztec Code Enable / Disable

Enables/disables the ability of the reader to decode Aztec Code labels.



Aztec Code Length Control

This feature specifies either variable length decoding or fixed length decoding for this symbology.

Variable Length: For variable length decoding, a minimum and maximum length may be set.

Fixed Length: For fixed length decoding, two different lengths may be set.

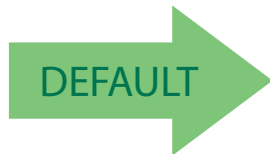



Aztec Code Set Length 1

Specifies one of the bar code lengths for Aztec Code Length Control. Length 1 is the minimum label length if in Variable Length Mode, or the first fixed length if in Fixed Length Mode. Characters can be set from 0001 to 3,832 characters in increments of 0001 (pad with zeroes).



Select Aztec Code Length 1 Setting

To configure this feature, scan the ENTER/EXIT PROGRAMMING MODE bar code above, then the bar code at left followed by the digits from the Alphanumeric characters in [Appendix D, Keypad](#) representing your desired character(s). End by scanning the ENTER/EXIT bar code again.

Make a mistake? Scan the CANCEL bar code to abort and not save the entry string. You can then start again at the beginning.



CANCEL

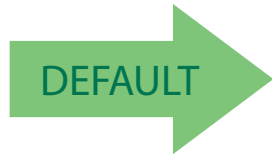

0001 = Length 1 is 1 Character



Aztec Code Set Length 2

This feature specifies one of the bar code lengths for Aztec Code Length Control. Length 2 is the maximum label length if in Variable Length Mode, or the second fixed length if in Fixed Length Mode. Characters can be set from 0001 to 3,832 characters in increments of 0001 (pad with zeroes).



Select Aztec Code Length 2 Setting

To configure this feature, scan the ENTER/EXIT PROGRAMMING MODE bar code above, then the bar code at left followed by the digits from the Alphanumeric characters in **Appendix D, Keypad** representing your desired character(s). End by scanning the ENTER/EXIT bar code again.

Make a mistake? Scan the CANCEL bar code to abort and not save the entry string. You can then start again at the beginning.



CANCEL

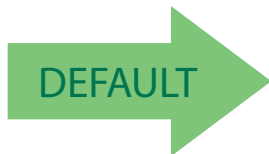

Length 2 is 3,832 Characters

China Sensible Code

China Sensible Code Enable / Disable

Enables/disables the ability of the reader to decode China Sensible Code labels.

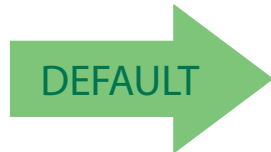

China Sensible Code = Disable



China Sensible Code = Enable

China Sensible Code Length Control

This feature specifies either variable length decoding or fixed length decoding for this symbology.

Variable Length: For variable length decoding, a minimum and maximum length may be set.

Fixed Length: For fixed length decoding, two different lengths may be set.

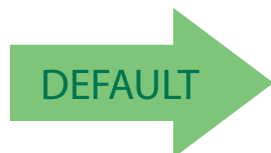

China Sensible Code Length Control = Variable Length



China Sensible Code Length Control = Fixed Length



China Sensible Code Set Length 1

Specifies one of the bar code lengths for China Sensible Code Length Control. Length 1 is the minimum label length if in Variable Length Mode, or the first fixed length if in Fixed Length Mode. Characters can be set from 0001 to 7,827 characters in increments of 0001 (pad with zeroes).



Select China Sensible Code Length 1 Setting

To configure this feature, scan the ENTER/EXIT PROGRAMMING MODE bar code above, then the bar code at left followed by the digits from the Alphanumeric characters in **Appendix D, Keypad** representing your desired character(s). End by scanning the ENTER/EXIT bar code again.

Make a mistake? Scan the CANCEL bar code to abort and not save the entry string. You can then start again at the beginning.



CANCEL

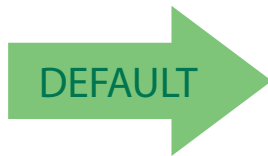

0001 = Length 1 is 1 Character



China Sensible Code Set Length 2

This feature specifies one of the bar code lengths for **China Sensible Code Length Control**. Length 2 is the maximum label length if in Variable Length Mode, or the second fixed length if in Fixed Length Mode. Characters can be set from 0001 to 7,827 characters in increments of 0001 (pad with zeroes).



Select China Sensible Code Length 2 Setting

To configure this feature, scan the ENTER/EXIT PROGRAMMING MODE bar code above, then the bar code at left followed by the digits from the Alphanumeric characters in **Appendix D, Keypad** representing your desired character(s). End by scanning the ENTER/EXIT bar code again.

Make a mistake? Scan the CANCEL bar code to abort and not save the entry string. You can then start again at the beginning.



CANCEL

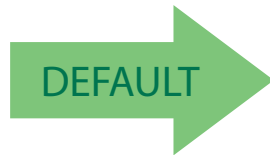

Length 2 is 7,827 Characters



Data Matrix

Data Matrix Enable / Disable

Enables/disables ability of reader to decode Data Matrix labels.



Data Matrix = Disable



Data Matrix = Enable



Data Matrix Square/Rectangular Style

Specifies the options available when reading Data Matrix with different form factors. Choices are:

- Square Style
- Rectangular Style
- Both Square and Rectangular Style

The configuration item can also be configured as a bit mask to filter one or more Data Matrix labels with different symbol size AND shape styles.



Data Matrix Dimensions Mask = Square Style



Data Matrix Dimensions Mask = Rectangular Style

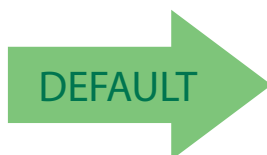

Data Matrix Dimensions Mask = Both Square and Rectangular Style



Data Matrix Length Control

This feature specifies either variable length decoding or fixed length decoding for this symbology.

Variable Length: For variable length decoding, a minimum and maximum length may be set.

Fixed Length: For fixed length decoding, two different lengths may be set.

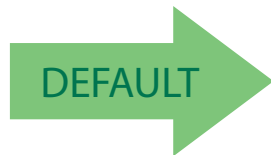

Data Matrix Length Control = Variable Length



Data Matrix Length Control = Fixed Length

Data Matrix Set Length 1

Specifies one of the bar code lengths for Data Matrix Length Control. Length 1 is the minimum label length if in Variable Length Mode, or the first fixed length if in Fixed Length Mode. Characters can be set from 0001 to 3,116 characters in increments of 0001 (pad with zeroes).



Select Data Matrix Length 1 Setting

To configure this feature, scan the ENTER/EXIT PROGRAMMING MODE bar code above, then the bar code at left followed by the digits from the Alphanumeric characters in [Appendix D, Keypad](#) representing your desired character(s). End by scanning the ENTER/EXIT bar code again.

Make a mistake? Scan the CANCEL bar code to abort and not save the entry string. You can then start again at the beginning.



CANCEL

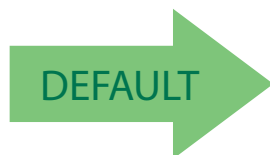

0001 = Length 1 is 1 Character



Data Matrix Set Length 2

This feature specifies one of the bar code lengths for **Data Matrix Length Control**. Length 2 is the maximum label length if in **Variable Length Mode**, or the second fixed length if in **Fixed Length Mode**. Characters can be set from 0001 to 3,116 characters in increments of 0001 (pad with zeroes).



Select Data Matrix Length 2 Setting

To configure this feature, scan the ENTER/EXIT PROGRAMMING MODE bar code above, then the bar code at left followed by the digits from the Alphanumeric characters in **Appendix D, Keypad** representing your desired character(s). End by scanning the ENTER/EXIT bar code again.

Make a mistake? Scan the CANCEL bar code to abort and not save the entry string. You can then start again at the beginning.



CANCEL

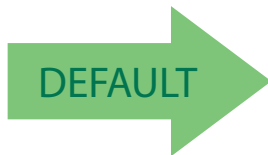

Length 2 is 3,116 Characters

GS1 DotCode

The following options apply for the DotCode barcode decoding.

DotCode Enable

This options enables/disables the ability of the scanner to decode DotCode barcodes.



DotCode High Resolution Enable

This options improves the decoding performance for very small module size barcodes, e.g. tobacco products..

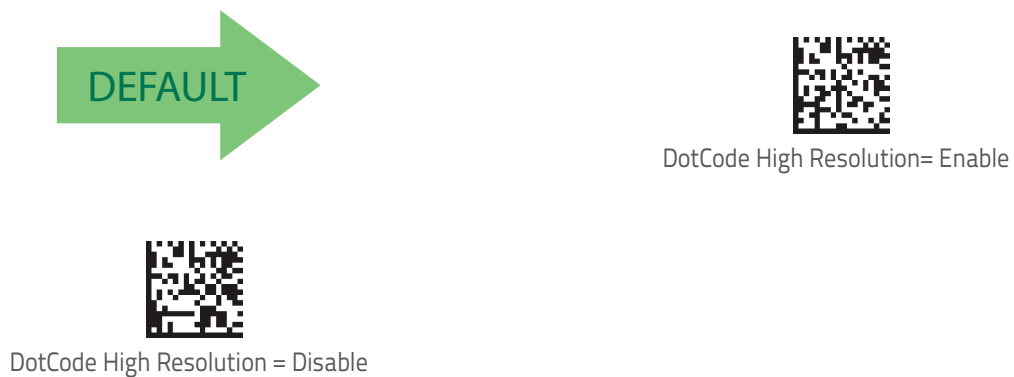

DotCode Position-based Decoding

This option can improve the decoding performance when the next barcode to be decoded is approximately shown in the same position as the previous one.



Additional Options

To improve performances the following additional settings are available using the configuration utility.

- Dot Size
- Fixed Length or Variable Length
- Min and Max barcode size

Maxicode

Maxicode Enable / Disable

Enables/disables ability of reader to decode Maxicode labels.



Maxicode Primary Message Transmission

Enables/disables the transmission of only the Primary Message when the Secondary Message is not readable.

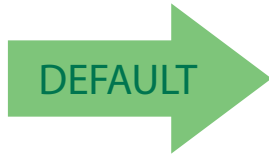

Maxicode Primary Message Transmission = Disable



Maxicode Primary Message Transmission = Enable



Maxicode Length Control

This feature specifies either variable length decoding or fixed length decoding for this symbology.

Variable Length: For variable length decoding, a minimum and maximum length may be set.

Fixed Length: For fixed length decoding, two different lengths may be set.

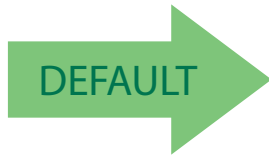

Maxicode Length Control = Variable Length



Maxicode Length Control = Fixed Length

Maxicode Set Length 1

Specifies one of the bar code lengths for **Maxicode Length Control**. Length 1 is the minimum label length if in **Variable Length Mode**, or the first fixed length if in **Fixed Length Mode**. Characters can be set from 0001 to 0145 characters in increments of 0001 (pad with zeroes).



Select Maxicode Length 1 Setting

To configure this feature, scan the ENTER/EXIT PROGRAMMING MODE bar code above, then the bar code at left followed by the digits from the Alphanumeric characters in **Appendix D, Keypad** representing your desired character(s). End by scanning the ENTER/EXIT bar code again.

Make a mistake? Scan the CANCEL bar code to abort and not save the entry string. You can then start again at the beginning.



CANCEL

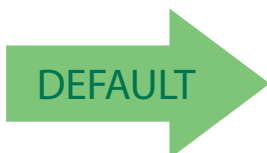

0001 = Length 1 is 1 Character



Maxicode Set Length 2

This feature specifies one of the bar code lengths for **Maxicode Length Control**. Length 2 is the maximum label length if in Variable Length Mode, or the second fixed length if in Fixed Length Mode. Characters can be set from 0001 to 0145 characters in increments of 0001 (pad with zeroes).



Select Maxicode Length 2 Setting

To configure this feature, scan the ENTER/EXIT PROGRAMMING MODE bar code above, then the bar code at left followed by the digits from the Alphanumeric characters in **Appendix D, Keypad** representing your desired character(s). End by scanning the ENTER/EXIT bar code again.

Make a mistake? Scan the CANCEL bar code to abort and not save the entry string. You can then start again at the beginning.



CANCEL



Length 2 is 0145 Characters



PDF417

PDF417 Enable / Disable

Enables/disables the ability of the reader to decode PDF417 labels.



PDF417 = Disable



PDF417 = Enable



PDF417 Length Control

This feature specifies either variable length decoding or fixed length decoding for this symbology.

Variable Length: For variable length decoding, a minimum and maximum length may be set.

Fixed Length: For fixed length decoding, two different lengths may be set.

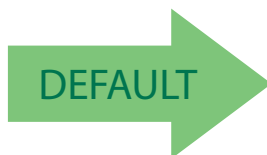

PDF417 Length Control = Variable Length



PDF417 Length Control = Fixed Length



PDF417 Set Length 1

Specifies one of the bar code lengths for PDF417 Length Control. Length 1 is the minimum label length if in Variable Length Mode, or the first fixed length if in Fixed Length Mode. Length includes the bar code's data characters only. Characters can be set from 0001 to 2,710 characters (pad with zeroes) in increments of 01. Any value greater than 2,710 will be considered to be 2,710.



Select PDF417 Length 1 Setting

To configure this feature, scan the ENTER/EXIT PROGRAMMING MODE bar code above, then the bar code at left followed by the digits from the Alphanumeric characters in [Appendix D, Keypad](#) representing your desired character(s). End by scanning the ENTER/EXIT bar code again.

Make a mistake? Scan the CANCEL bar code to abort and not save the entry string. You can then start again at the beginning.



CANCEL

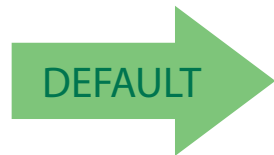

0001 = Length 1 is 1 Character



PDF417 Set Length 2

This feature specifies one of the bar code lengths for PDF417 Length Control. Length 2 is the maximum label length if in Variable Length Mode, or the second fixed length if in Fixed Length Mode. Length includes the bar code's check, data, and full-ASCII shift characters. The length does not include start/stop characters. Characters can be set from 01 to 2,710 characters (pad with zeroes) in increments of 01. Any value greater than 2,710 will be considered to be 2,710.



Select PDF417 Length 2 Setting

To configure this feature, scan the ENTER/EXIT PROGRAMMING MODE bar code above, then the bar code at left followed by the digits from the Alphanumeric characters in **Appendix D, Keypad** representing your desired character(s). End by scanning the ENTER/EXIT bar code again.

Make a mistake? Scan the CANCEL bar code to abort and not save the entry string. You can then start again at the beginning.



CANCEL

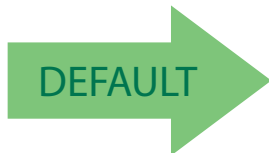

Length 2 is 2,710 Characters

Micro PDF417

Micro PDF417 Enable / Disable

Enables/disables the ability of the reader to decode Micro PDF417 labels.

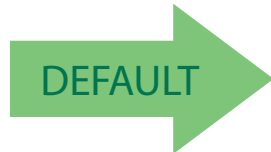

Micro PDF417 = Disable



Micro PDF417 = Enable

Micro PDF417 Code 128 GS1-128 Emulation

Specifies which AIM ID to use for MicroPDF labels when doing Code 128 or GS1-128 emulation.

Emulation choices are:

- Micro PDF AIM ID and label type
- Code 128 / EAN128 AIM Id and label type

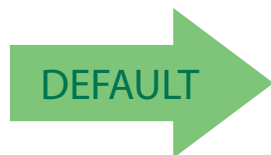

Micro PDF417 Code 128 GS1-128 Emulation =
Micro PDF AIM ID and label type



Micro PDF417 Code 128 GS1-128 Emulation =
Code 128 / EAN128 AIM ID and label type



Micro PDF417 Length Control

This feature specifies either variable length decoding or fixed length decoding for this symbology.

Variable Length: For variable length decoding, a minimum and maximum length may be set.

Fixed Length: For fixed length decoding, two different lengths may be set.

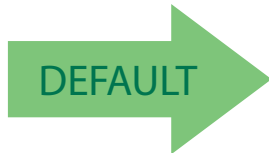

Micro PDF417 Length Control = Variable Length



Micro PDF417 Length Control = Fixed Length

Micro PDF417 Set Length 1

Specifies one of the bar code lengths for Micro PDF417 Length Control. Length 1 is the minimum label length if in Variable Length Mode, or the first fixed length if in Fixed Length Mode. Length includes the bar code's data characters only. Characters can be set from 0001 to 0366 characters (pad with zeroes) in increments of 01. Any value greater than 0366 will be considered to be 0366.



Select Micro PDF417 Length 1 Setting

To configure this feature, scan the ENTER/EXIT PROGRAMMING MODE bar code above, then the bar code at left followed by the digits from the Alphanumeric characters in **Appendix D, Keypad** representing your desired character(s). End by scanning the ENTER/EXIT bar code again.

Make a mistake? Scan the CANCEL bar code to abort and not save the entry string. You can then start again at the beginning.



CANCEL

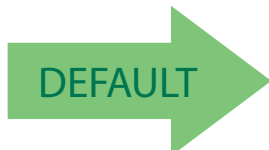

0001 = Length 1 is 1 Character



Micro PDF417 Set Length 2

This feature specifies one of the bar code lengths for Micro PDF417 Length Control. Length 2 is the maximum label length if in Variable Length Mode, or the second fixed length if in Fixed Length includes the bar code's data characters only. Characters can be set from 0001 to 0366 characters (pad with zeroes) in increments of 01. Any value greater than 0366 will be considered to be 0366.



Select Micro PDF417 Length 2 Setting

To configure this feature, scan the ENTER/EXIT PROGRAMMING MODE bar code above, then the bar code at left followed by the digits from the Alphanumeric characters in [Appendix D, Keypad](#) representing your desired character(s). End by scanning the ENTER/EXIT bar code again.

Make a mistake? Scan the CANCEL bar code to abort and not save the entry string. You can then start again at the beginning.



CANCEL

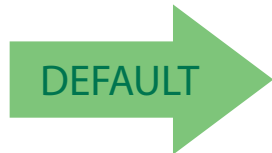

Length 2 is 0366 Characters



QR Code

QR Code Enable / Disable

Enables/disables the ability of the reader to decode QR Code labels.



QR Code Length Control

This feature specifies either variable length decoding or fixed length decoding for this symbology.

Variable Length: For variable length decoding, a minimum and maximum length may be set.

Fixed Length: For fixed length decoding, two different lengths may be set.

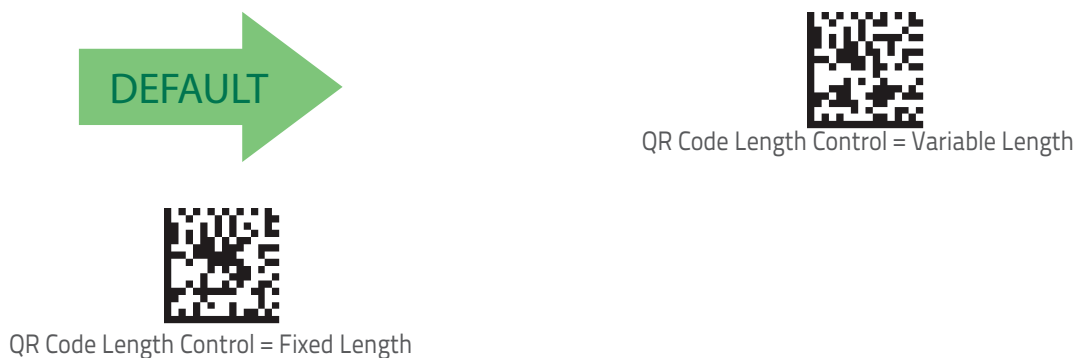



QR Code Set Length 1

Specifies one of the bar code lengths for QR Code Length Control. Length 1 is the minimum label length if in Variable Length Mode, or the first fixed length if in Fixed Length Mode. Characters can be set from 0001 to 7,089 characters in increments of 0001 (pad with zeroes).



Select QR Code Length 1 Setting

To configure this feature, scan the ENTER/EXIT PROGRAMMING MODE bar code above, then the bar code at left followed by the digits from the Alphanumeric characters in [Appendix D, Keypad](#) representing your desired character(s). End by scanning the ENTER/EXIT bar code again.

Make a mistake? Scan the CANCEL bar code to abort and not save the entry string. You can then start again at the beginning.



CANCEL

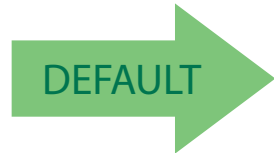

0001 = Length 1 is 1 Character



QR Code Set Length 2

This feature specifies one of the bar code lengths for QR Code Length Control. Length 2 is the maximum label length if in Variable Length Mode, or the second fixed length if in Fixed Length Mode. Characters can be set from 0001 to 7,089 characters in increments of 0001 (pad with zeroes).



Select QR Code Length 2 Setting

To configure this feature, scan the ENTER/EXIT PROGRAMMING MODE bar code above, then the bar code at left followed by the digits from the Alphanumeric characters in [Appendix D, Keypad](#) representing your desired character(s). End by scanning the ENTER/EXIT bar code again.

Make a mistake? Scan the CANCEL bar code to abort and not save the entry string. You can then start again at the beginning.



CANCEL

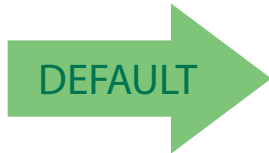

Length 2 is 7,089 Characters

Micro QR Code

Micro QR Code Enable/Disable

Enables/disables the ability of the reader to decode Micro QR Code labels.

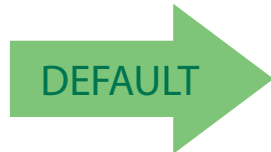

Micro QR Code = Disable



Micro QR Code = Enable

Micro QR Code Length Control

This feature specifies either variable length decoding or fixed length decoding for this symbology.

Variable Length: For variable length decoding, a minimum and maximum length may be set.

Fixed Length: For fixed length decoding, two different lengths may be set.



Micro QR Code Length Control = Variable Length



Micro QR Code Length Control = Fixed Length



Micro QR Code Set Length 1

Specifies one of the bar code lengths for **Micro QR Code Length Control**. Length 1 is the minimum label length if in **Variable Length Mode**, or the first fixed length if in **Fixed Length Mode**. Characters can be set from 0001 to 0035 characters in increments of 0001 (pad with zeroes).



Select Micro QR Code Length 1 Setting

To configure this feature, scan the ENTER/EXIT PROGRAMMING MODE bar code above, then the bar code at left followed by the digits from the Alphanumeric characters in **Appendix D, Keypad** representing your desired character(s). End by scanning the ENTER/EXIT bar code again.

Make a mistake? Scan the CANCEL bar code to abort and not save the entry string. You can then start again at the beginning.



CANCEL

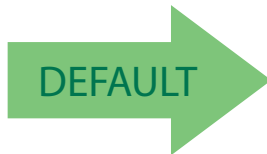

0001 = Length 1 is 1 Character



Micro QR Code Set Length 2

This feature specifies one of the bar code lengths for **Micro QR Code Length Control**. Length 2 is the maximum label length if in Variable Length Mode, or the second fixed length if in Fixed Length Mode. Characters can be set from 0001 to 0035 characters in increments of 0001 (pad with zeroes).



Select Micro QR Code Length 2 Setting

To configure this feature, scan the ENTER/EXIT PROGRAMMING MODE bar code above, then the bar code at left followed by the digits from the Alphanumeric characters in **Appendix D, Keypad** representing your desired character(s). End by scanning the ENTER/EXIT bar code again.

Make a mistake? Scan the CANCEL bar code to abort and not save the entry string. You can then start again at the beginning.



CANCEL

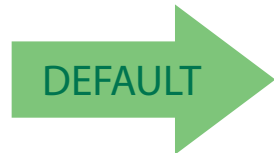

Length 2 is 0035 Characters



UCC Composite

UCC Optional Composite Timer

Specifies the amount of time the system will wait for the stacked part of a UCC Composite label before transmitting the linear label without an add-on.



UCC Optional Composite Timer = Timer Disabled



UCC Optional Composite Timer = 70msec



UCC Optional Composite Timer = 100msec



UCC Optional Composite Timer = 200msec



UCC Optional Composite Timer = 300msec

Postal Code Selection

Enables/disables the ability of the scanner to decode labels of a specific postal symbology.

- Disable All Postal Codes
- Postnet
- Planet
- Royal Mail
- Kix
- Australia Post
- Japan Post
- IMB
- Sweden Post
- Portugal Post



Postal Code Selection = Disable All Postal Codes



Postal Code Selection = Enable Postnet



Postal Code Selection = Enable Planet



Postal Code Selection = Enable Royal Mail



Postal Code Selection = Enable Kix



Postal Code Selection = Enable Australia Post

Postal Code Selection (continued)



Postal Code Selection = Enable Japan Post



Postal Code Selection = Enable IMB



Postal Code Selection = Enable Sweden Post



Postal Code Selection = Enable Portugal Post

Postnet BB Control

Controls the ability of the scanner to decode B and B' fields of Postnet labels.

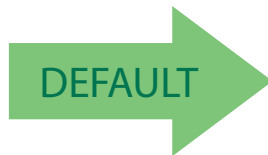

Postnet BB Control = Disable



Postnet BB Control = Enable

OCR Decoding

The scanner family is equipped with an Optical Character Recognition feature.

This section describes how to configure the barcode scanner to enable OCR decoding.

The scanner supports the following OCR font types:

- OCR-A
- OCR-B
- MICR E13B
- US Currency Serial Number.

In most OCR applications a suitable usage of check digits and the addition of constraints on sub-strings types (e.g. digits-only or letter-only) reduces mis-decoding probabilities.

The user can choose between a set of predefined templates (already optimized for decoding) and customizable free templates.

For free templates, as OCR decoding is less reliable than traditional barcode decoding, the scanner provides tools to minimize misdecoded labels. As a result, particular care shall be dedicated to the setup of free custom templates to reduce incorrect output.

For more information on how to customize the user templates for your needs, please contact Technical Support.

Use one of the following labels to enable one of the predefined templates for OCR decoding.

OCR predefined template: EU ID Card OCR Format



EU Identity Card OCR

OCR predefined template: IATA Passport



IATA Passport OCR

OCR predefined template: Italian Post payment form



Italian Post OCR Payment

OCR predefined template: Italian Bank payment form



Enable Italian Bank Freccia Bank Payment form

OCR predefined template: Swiss Driving License



Enable Swiss Driving License OCR

OCR Decoding Disable

Use the following label to turn off the OCR decoding feature:



Disable OCR function



NOTES

Motion Features

MOTION AIMING CONTROL
MOTION SENSITIVITY
MOTIONLESS TIMEOUT

Use this chapter to configure motion settings for the handheld.
Reference [Appendix B](#), for a listing of standard factory settings.

Motion Aiming Control

Configures the ability of the scanner to Enable/Disable the Aiming system when motion is detected.

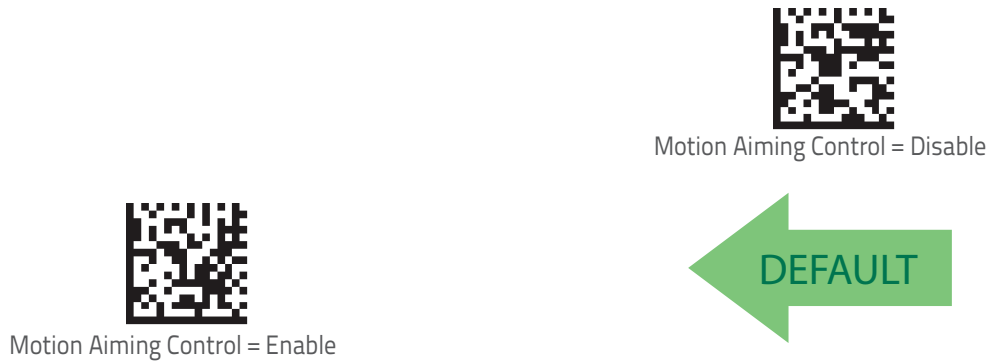

Motion Sensitivity

Defines discrete set of levels for scanner motion sensitivity when in handheld use.

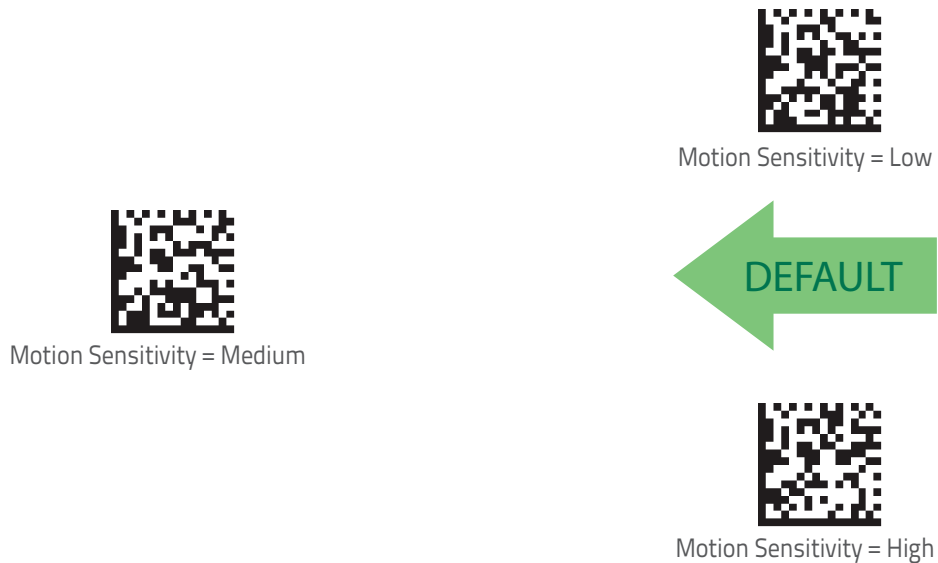

Motionless Timeout

Specifies the waiting time in 100 millisecond ticks to assume that the reader is in a motionless condition. The selectable range is 500 msec to 25.5 Seconds. When no motion event is detected for a period of time longer than this timeout, the software assumes the reader is in a motionless condition. This normally results in returning the scanner to Stand Mode. This option relates to such features as Aimer On and Stand Mode/Object Detection scanning with respect to motion.



Select Motionless Timeout Setting

To configure this feature, scan the ENTER/EXIT PROGRAMMING MODE bar code above, then the bar code at left followed by three digits from the Alphanumeric characters in [Appendix D, Keypad](#) representing your desired character(s). End by scanning the ENTER/EXIT bar code again.

Make a mistake? Scan the CANCEL bar code to abort and not save the entry string. You can then start again at the beginning.



CANCEL

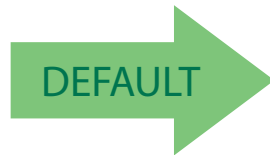

020 = Motionless Timeout = 2 seconds

Chapter 4

References

This section contains explanations and examples of selected bar code features. See "Configuration Using Bar Codes" for the actual bar code labels used to configure the scanner.

RS-232 PARAMETERS
<ul style="list-style-type: none">▪ RS-232 Only▪ RS-232/USB COM Parameters
KEYBOARD INTERFACE
<ul style="list-style-type: none">▪ Wedge Quiet Interval▪ Intercharacter Delay▪ Intercode Delay
DATA FORMAT
<ul style="list-style-type: none">▪ Data Editing▪ Global Prefix/Suffix▪ Global AIM ID▪ Label ID▪ Character Conversion
SCANNING FEATURES
<ul style="list-style-type: none">▪ Scanning Features
SCANNING FEATURES
<ul style="list-style-type: none">▪ Scan Mode▪ Scanning Active Time▪ Flash On Time▪ Flash Off Time
SYMBOLOGIES
<ul style="list-style-type: none">▪ Set Length▪ Set Length

RS-232 Parameters

RS-232 Only

Baud Rate

Baud rate is the number of bits of data transmitted per second. Set the scanner's baud rate to match the baud rate setting of the host device. With an improper baud rate setting, data may not reach the host correctly.

Data Bits

This parameter allows the reader to interface with devices requiring a 7-bit or 8-bit ASCII protocol for sending and receiving data.

Stop Bits

The stop bit(s) at the end of each transmitted character marks the end of transmission of one character and prepares the receiving device for the next character in the serial data stream. The number of stop bits selected (one or two) depends on the number the receiving terminal is programmed to accommodate. Set the number of stop bits to match host device requirements.

Parity

This feature specifies parity required for sending and receiving data. A parity check bit is the most significant bit of each ASCII coded character. Select the parity type according to host device requirements.

- Select None when no parity bit is required.
- Select Odd parity and the parity bit value is set to 0 or 1, based on data, to ensure that an odd number of 1 bits are contained in the coded character.
- Select Even parity and the parity bit value is set to 0 or 1, based on data, to ensure that an even number of 1 bits are contained in the coded character.

Handshaking Control

The data interface consists of an RS-232 port designed to operate either with or without the hardware handshaking lines, Request to Send (RTS), and Clear to Send (CTS). Handshaking Control includes the following options:

- RTS — RTS is asserted during transmissions. CTS is ignored.
- RTS/CTS — RTS is asserted during transmissions. CTS gates transmissions.
- RTS/XON/XOFF — RTS is asserted during transmissions. CTS is ignored. XON and XOFF gate transmissions.
- RTS On/CTS — RTS is always asserted. CTS gates transmissions.
- RTS/CTS Scan Control — RTS is asserted during transmissions. CTS gates transmissions and controls enable and disable state of scanner.

RS-232/USB COM Parameters

Intercharacter Delay

This parameter specifies the intercharacter delay between the end of one character and the beginning of the next. The delay can be set within a range of zero (0) to 990 milliseconds in 10ms increments. A setting of zero specifies no delay.

To set the delay:

1. Determine the desired setting in milliseconds.
2. Divide the desired setting by 10 (setting is in 10ms increments). Pad the result with leading zeroes to yield two digits. For example: 0 = 00, 5 = 05, 20 = 20, etc.
3. Scan the ENTER/EXIT PROGRAMMING MODE bar code to enter Programming Mode.
4. Scan the bar code: SELECT INTERCHARACTER DELAY SETTING.
5. Scan the appropriate two digits from the keypad in [Appendix D, Keypad](#), that represent the duration which was determined in the steps above. You will hear a two-beep indication after the last character.



If you make a mistake before the last character, scan the CANCEL bar code to abort and not save the entry string. You can then start again at the beginning.

NOTE

6. Scan the ENTER/EXIT PROGRAMMING MODE bar code to exit.

This completes the procedure. See the following table for examples of how to set this feature.

Table 11. Intercharacter Delay Setting Examples

STEP	ACTION	EXAMPLES			
1	Desired Setting	50ms	150ms	600ms	850ms
2	Divide by 10 (pad with leading zeroes to yield two-digits)	05	15	60	85
3	Scan ENTER/EXIT PROGRAMMING MODE				
4	Scan SELECT INTERCHARACTER DELAY SETTING				
5	Scan Two Characters From Appendix D, Keypad	'0' and '5'	'1' and '5'	'6' and '0'	'8' and '5'
6	Scan ENTER/EXIT PROGRAMMING MODE				

ACK NAK Options

This enables/disables the ability of the scanner to support the RS-232 ACK/NAK protocol. When configured, the scanner and/or host sends an “ACK” when it receives data properly, and sends “NAK” when the data is in error.

Options are:

- Disable
- Enable for label transmission — The scanner expects an ACK/NAK response from the host when a label is sent
- Enable for host-command acknowledge — The scanner will respond with ACK/NAK when the host sends a command
- Enable for label transmission and host-command acknowledge

ACK Character

This setting specifies an ASCII character or hex value to be used as the ACK character. ASCII characters or any hex value from 0 to 0xFF can be selected.



NOTE

Setting to previously defined characters such as XON, XOFF, or host commands conflicts with normal operation of these characters. 8-bit data is not recognized when the option Data Bits has been set as 7 Data Bits.

1. Determine the desired character or value.
2. Use the [ASCII Chart](#) at the back of this manual to find the hex equivalent for the desired character/value.
3. Scan ENTER/EXIT PROGRAMMING MODE to enter Programming Mode.
4. Scan the bar code: SELECT ACK CHARACTER SETTING.
5. Scan the appropriate two alphanumeric characters from the keypad in [Appendix D, Keypad](#), that represent the desired character/value determined above. The second character will cause a two-beep indication.
6. Scan the ENTER/EXIT PROGRAMMING MODE bar code to exit.

See the table below for examples of how to set this feature.

Table 12. ACK Character Setting Examples

STEP	ACTION	EXAMPLES			
1	Desired Character/Value	ACK	\$	@	>
2	Hex equivalent from ASCII Chart	0x06	0x24	0x40	0x3E
3	Scan ENTER/EXIT PROGRAMMING MODE				
4	Scan SELECT ACK CHARACTER SETTING				
5	Scan Two Characters from Appendix D, Keypad	'0' and '6'	'2' and '4'	'4' and '0'	'3' AND 'E'
6	Scan ENTER/EXIT PROGRAMMING MODE				

NAK Character

This setting specifies an ASCII character or hex value to be used as the NAK character. ASCII characters or any hex value from 0 to 0xFF can be selected.



NOTE

Setting to previously defined characters such as XON, XOFF, or host commands conflicts with normal operation of these characters. 8-bit data is not recognized when the option Data Bits on has been set as 7 Data Bits.

To set this feature:

1. Determine the desired character or value.
2. Use the [ASCII Chart](#) on the inside back cover of this manual to find the hex equivalent for the desired character/value.
3. Scan the ENTER/EXIT PROGRAMMING MODE bar code to enter Programming Mode.
4. Scan the bar code: SELECT NAK CHARACTER SETTING.
5. Scan the appropriate two alpha-numeric characters from the keypad in [Appendix D, Keypad](#), that represent the desired character/value determined above. The second character will cause a two-beep indication.
6. Scan the ENTER/EXIT PROGRAMMING MODE bar code to exit Programming Mode.

This completes the procedure. See the table below for examples of how to set this feature.

Table 13. NAK Character Setting Examples

STEP	ACTION	EXAMPLES			
1	Desired Character/Value	NAK	\$	@	>
2	Hex equivalent	0x15	0x24	0x40	0x3E
3	Scan ENTER/EXIT PROGRAMMING MODE				
4	Scan SELECT NAK CHARACTER SETTING				
5	Scan Two Characters From Appendix D, Keypad	'1' and '5'	'2' and '4'	'4' and '0'	'3' AND 'E'
6	Scan ENTER/EXIT PROGRAMMING MODE				

ACK NAK Timeout Value

This option specifies the amount of time the scanner waits for an ACK character from the host following label transmission. The selectable timeout range is 200 milliseconds to 15,000ms (15 seconds) in 200ms increments. A selection of 0 disables the timeout.

To set this value:

1. Determine the desired setting in milliseconds.
2. Divide the desired setting by 200 (setting is in 200ms increments). Pad the result with leading zeroes to yield two digits. For example: 0 = 00, 5 = 05, 20 = 20, etc.
3. Scan the ENTER/EXIT PROGRAMMING MODE bar code to enter Programming Mode.
4. Scan the bar code: SELECT ACK NAK TIMEOUT VALUE SETTING.
5. Scan the appropriate two digits from the keypad in [Appendix D, Keypad](#), that represent the duration which was determined in the steps above. You will hear a two-beep indication after the last character.



NOTE

If you make a mistake before the last character, scan the CANCEL bar code to abort and not save the entry string. You can then start again at the beginning.

6. Scan the ENTER/EXIT PROGRAMMING MODE bar code to exit Programming Mode.

This completes the procedure. See the table below for examples of how to set this feature.

Table 14. ACK NAK Timeout Value Setting Examples

STEP	ACTION	EXAMPLES			
1	Desired Setting	200ms	1,000ms (1 sec.)	5200ms (5.2 sec.)	15,000ms (15 sec.)
2	Divide by 200	01	05	26	75
3	Scan ENTER/EXIT PROGRAMMING MODE				
4	Scan SELECT ACK NAK TIMEOUT VALUE SETTING				
5	Scan Two Characters From Appendix D, Keypad	'0' and '1'	'0' and '5'	'2' and '6'	'7' and '5'
6	Scan ENTER/EXIT PROGRAMMING MODE				

ACK NAK Retry Count

This feature specifies the number of times the scanner retries a label transmission due to a retry condition. The selectable range is from 1 to 254 retries. A selection of 0 disables the count, and a selection of 255 specifies unlimited retries.

To set this feature:

1. Determine the desired setting.
2. Pad the number with leading zeroes to yield three digits. For example: 0 = 000, 5 = 005, 20 = 020, etc.
3. Scan the ENTER/EXIT PROGRAMMING MODE bar code to enter Programming Mode.
4. Scan the bar code: SELECT ACK NAK RETRY COUNT SETTING.
5. Scan the appropriate three digits from the keypad in Appendix D, Keypad, that represent the number which was determined in the steps above. You will hear a two-beep indication after the last character.



NOTE

If you make a mistake before the last character, scan the CANCEL bar code to abort and not save the entry string. You can then start again at the beginning.

6. Scan the ENTER/EXIT PROGRAMMING MODE bar code to exit Programming Mode.

This completes the procedure. See the table below for examples of how to set this feature.

Table 15. ACK NAK Retry Count Setting Examples

STEP	ACTION	EXAMPLES			
1	Desired Setting	Disable Retry Count	3 Retries	54 Retries	Unlimited Retries
2	Pad with leading zero(es)	000	003	054	255
3	Scan ENTER/EXIT PROGRAMMING MODE				
4	Scan SELECT ACK NAK RETRY COUNT SETTING				
5	Scan Three Characters From Appendix D, Keypad	'0', '0' and '0'	'0', '0' and '3'	'0', '5' and '4'	'2', '5' and '5'
6	Scan ENTER/EXIT PROGRAMMING MODE				

Disable Character

Specifies the value of the RS-232 host command used to disable the scanner. ASCII characters or any hex value from 0 to 0xFF can be selected.



NOTE

Setting to previously defined characters such as XON, XOFF, or host commands conflicts with normal operation of these characters. 8-bit data is not recognized when the option Data Bits has been set as 7 Data Bits.

To set the value:

1. Determine the desired character or value. A setting of 0xFF indicates the Disable Character is not used (not available).
2. Use the [ASCII Chart](#) on the inside back cover of this manual to find the hex equivalent for the desired character/value.
3. Scan the ENTER/EXIT PROGRAMMING MODE bar code to enter Programming Mode.
4. Scan the bar code: SELECT DISABLE CHARACTER SETTING.
5. Scan the appropriate two alphanumeric characters from the keypad in [Appendix D, Keypad](#), that represent the desired character/value determined above. The second character will cause a two-beep indication.
6. Scan the ENTER/EXIT PROGRAMMING MODE bar code to exit Programming Mode.

This completes the procedure. See the table below for examples of how to set this feature.

Table 16. Disable Character Setting Examples

STEP	ACTION	EXAMPLES			
1	Desired character/value	'd'	'y'	'D'	Disable Command Not Used
2	Hex equivalent from ASCII Chart	0x64	0x7D	0x44	0xFF
3	Scan ENTER/EXIT PROGRAMMING MODE				
4	Scan SELECT DISABLE CHARACTER VALUE SETTING				
5	Scan Two Characters From Appendix D, Keypad	'6' and '4'	'7' and 'D'	'4' and '4'	'F' and 'F'
6	Scan ENTER/EXIT PROGRAMMING MODE				

Enable Character

Specifies the value of the RS-232 host command used to enable the scanner. ASCII characters or any hex value from 0 to 0xFF can be selected.



NOTE

Setting to previously defined characters such as XON, XOFF, or host commands conflicts with normal operation of these characters. 8-bit data is not recognized when the option Data Bits has been set as 7 Data Bits.

To set this feature:

Determine the desired character or value. A setting of 0xFF indicates the Enable Character is not used (not available).

1. Determine the desired character or value.
2. Use the [ASCII Chart](#) on the inside back cover of this manual to find the hex equivalent for the desired character/value.
3. Scan the ENTER/EXIT PROGRAMMING MODE bar code to enter Programming Mode.
4. Scan the bar code: SELECT ENABLE CHARACTER SETTING.
5. Scan the appropriate two alphanumeric characters from the keypad in [Appendix D, Keypad](#), that represent the desired character/value determined above. The second character will cause a two-beep indication.
6. Scan the ENTER/EXIT PROGRAMMING MODE bar code to exit Programming Mode.

This completes the procedure. See the table below for examples of how to set this feature.

Table 17. Enable Character Setting Examples

STEP	ACTION	EXAMPLES			
1	Desired character/value	'e'	'}'	'E'	Enable Command Not Used
2	Hex equivalent from ASCII Chart	0x65	0x7D	0x45	0xFF
3	Scan ENTER/EXIT PROGRAMMING MODE				
4	Scan SELECT ENABLE CHARACTER SETTING				
5	Scan Two Characters From Appendix D, Keypad	'6' and '5'	'7' and 'D'	'4' and '5'	'F' and 'F'
6	Scan ENTER/EXIT PROGRAMMING MODE				

Keyboard Interface

Wedge Quiet Interval

Specifies the amount of time the scanner looks for keyboard activity before it breaks the keyboard connection in order to transmit data to host. The range is from 0 to 990ms in 10ms increments.



This feature applies **ONLY** to the Keyboard Wedge interface.

NOTE

1. Determine the desired setting in milliseconds.
2. Divide the desired setting by 10 (setting is in 10ms increments). Pad the result with leading zeroes to yield two digits. For example: 0 = 00, 5 = 05, 20 = 20, etc.
3. Scan the ENTER/EXIT PROGRAMMING MODE bar code to enter Prog. Mode.
4. Scan the bar code: SELECT WEDGE QUIET INTERVAL SETTING.
5. Scan the appropriate two digits from the keypad in [Appendix D, Keypad](#), that represent the duration which was determined in the steps above. You will hear a two-beep indication after the last character.



If you make a mistake before the last character, scan the **CANCEL** bar code to abort and not save the entry string. You can then start again at the beginning.

NOTE

6. Scan the ENTER/EXIT PROGRAMMING MODE bar code to exit.

This completes the procedure to set the Wedge Quiet Interval. See the table below for examples of how to set this feature.

Table 18. Wedge Quiet Interval Setting Examples

STEP	ACTION	EXAMPLES			
1	Desired Setting	10ms	150ms	600ms	850ms
2	Divide by 10 (and pad with leading zeroes)	01	15	60	85
3	Scan ENTER/EXIT PROGRAMMING MODE				
4	Scan SELECT WEDGE QUIET INTERVAL SETTING				
5	Scan Two Characters From Appendix D, Keypad	'0' and '1'	'1' and '5'	'6' and '0'	'8' and '5'
6	Scan ENTER/EXIT PROGRAMMING MODE				

Intercharacter Delay

This parameter specifies the intercharacter delay between the end of one character and the beginning of the next. The delay can be set within a range of zero (0) to 990 milliseconds in 10ms increments. A setting of zero specifies no delay.



This feature applies **ONLY** to the Keyboard Wedge interface.

NOTE

To set the delay:

1. Determine the desired setting in milliseconds.
2. Divide the desired setting by 10 (setting is in 10ms increments). Pad the result with leading zeroes to yield two digits. For example: 0 = 00, 5 = 05, 20 = 20, etc.
3. Scan the ENTER/EXIT PROGRAMMING MODE bar code to enter Programming Mode.
4. Scan the bar code: SELECT INTERCHARACTER DELAY SETTING.
5. Scan the appropriate two digits from the keypad in [Appendix D, Keypad](#), that represent the duration which was determined in the steps above. You will hear a two-beep indication after the last character.



If you make a mistake before the last character, scan the **CANCEL** bar code to abort and not save the entry string. You can then start again at the beginning.

NOTE

6. Scan the ENTER/EXIT PROGRAMMING MODE bar code to exit Programming Mode.

This completes the procedure. See the table below for examples of how to set this feature.

Table 19. Intercharacter Delay Setting Examples

STEP	ACTION	EXAMPLES			
1	Desired Setting	50ms	150ms	600ms	850ms
2	Divide by 10 (and pad with leading zeroes to yield two-digits)	05	15	60	85
3	Scan ENTER/EXIT PROGRAMMING MODE				
4	Scan SELECT INTERCHARACTER DELAY SETTING				
5	Scan Two Characters From Appendix D, Keypad	'0' and '5'	'1' and '5'	'6' and '0'	'8' and '5'
6	Scan ENTER/EXIT PROGRAMMING MODE				

Intercode Delay

Specifies the delay between labels transmitted to the host for this interface. The selectable range for this feature is from 0 to 99 seconds.

Follow these instructions to set this feature:

1. Determine the desired setting.
2. Pad the number with leading zeroes to yield two digits. For example: 0 = 00, 5 = 05, 20 = 20, etc
3. Scan the ENTER/EXIT PROGRAMMING MODE bar code to enter Programming Mode.
4. Scan the bar code: SELECT INTERCODE DELAY SETTING.
5. Scan the appropriate two digits from the keypad in [Appendix D, Keypad](#), that represent the duration which was determined in the steps above. You will hear a two-beep indication after the last character.



NOTE

If you make a mistake before the last character, scan the CANCEL bar code to abort and not save the entry string. You can then start again at the beginning.

6. Scan the ENTER/EXIT PROGRAMMING MODE bar code to exit Programming Mode.

This completes the procedure. See the table below for examples of how to set this feature.

Table 20. Wedge Intercode Delay Examples

STEP	ACTION	EXAMPLES			
1	Desired Setting	No Delay	5 Seconds	60 Seconds	99 Seconds
2	Pad with leading zero(es)	00	05	60	99
3	Scan ENTER/EXIT PROGRAMMING MODE				
4	Scan SELECT INTERCODE DELAY SETTING				
5	Scan Two Characters From Appendix D, Keypad	'0' and '0'	'0' and '5'	'6' and '0'	'9' and '9'
6	Scan ENTER/EXIT PROGRAMMING MODE				

Data Format

Data Editing

When a bar code is scanned, additional information can be sent to the host computer along with the bar code data. This combination of bar code data and supplementary user-defined data is called a “message string.” The Data Editing features can be used to build specific user-defined data into a message string. There are several types of selectable data characters that can be sent before and after scanned data. You can specify if they should be sent with all symbologies, or only with specific symbologies. The following shows the available elements you can add to a message string:

Figure 17. Breakdown of a Message String

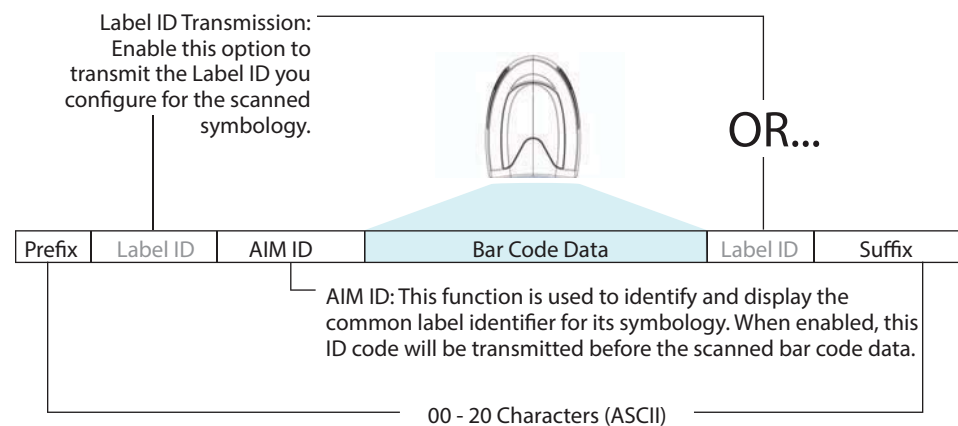

NOTE

Additional advanced editing is available. Contact Technical Support for more information.

Please Keep In Mind...

- Modifying a message string is not a mandatory requirement. Data editing is a sophisticated feature allowing highly customizable output for advanced users. Factory default settings for data editing is typically set to NONE.
- A prefix or suffix may be applied only to a specified symbology (reference 1D Symbologies) or across all symbologies (set via the Global features in Configuration Using Bar Codes).
- You can add any character from the ASCII Chart (from 00–FF) on the inside back cover of this manual as a prefix, suffix or Label ID.
- Enter prefixes and suffixes in the order in which you want them to appear on the output.

Global Prefix/Suffix

Up to 20 ASCII characters may be added as a prefix (in a position before the bar code data) and/or as a suffix (in a position following the bar code data) as indicated.

Figure 18. Prefix and Suffix Positions

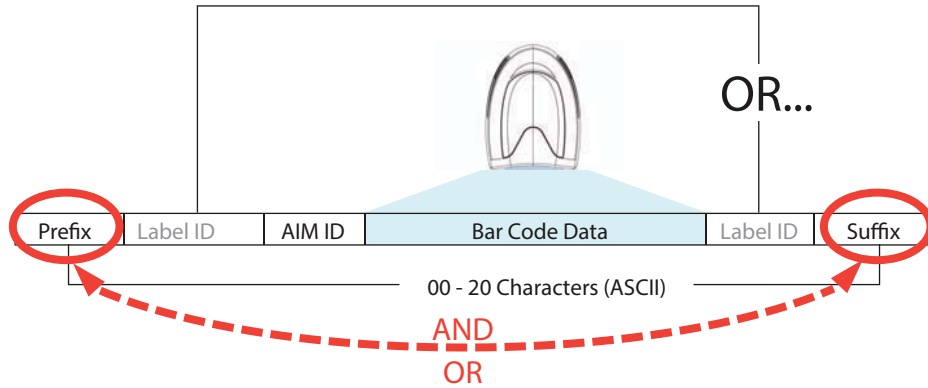

Example: Setting a Prefix

In this example, we'll set a prefix for all symbologies.

1. Determine which ASCII character(s) are to be added to scanned bar code data. In this example, we'll add a dollar sign ('\$') as a prefix.
2. Scan the ENTER/EXIT PROGRAMMING MODE bar code, then scan the SET GLOBAL PREFIX bar code.
3. Reference the [ASCII Chart](#) on the inside back cover of this manual to find the hex value assigned to the desired character. The corresponding hex number for the '\$' character is 24. To enter this selection code, scan the '2' and '4' bar codes from Appendix D, Keypad.



NOTE

If you make a mistake before the last character, scan the CANCEL bar code to abort and not save the entry string. You can then start again at the beginning.

4. If less than the expected string of 20 characters are selected, scan the ENTER/EXIT bar code to terminate the string.
5. Scan the ENTER/EXIT bar code once again to exit Programming Mode.
6. The resulting message string would appear as follows:
Scanned bar code data: **12345**
Resulting message string output: **\$12345**

Global AIM ID



This feature enables/disables addition of AIM IDs for all symbology types.

NOTE

AIM label identifiers (as opposed to custom characters you select yourself as with label identifiers) can be included with scanned bar code data. AIM label identifiers consist of three characters as follows:

- A close brace character (ASCII ‘}’), followed by...
- A code character (see the table below), followed by...
- A modifier character (the modifier character is symbol dependent).

SYMBOLGY	CHAR	SYMBOLGY	CHAR
UPC/EAN	E ^a	Code 128/GS1-128	C
Code 39 and Code 32	A	DataBar Omnidirectional, DataBar Expanded	e
Codabar	F	Standard 2 of 5	S
Interleaved 2 of 5	I	ISBN	X ^b
Code 93	G	Code 11	H

- a. UPC-A and UPC-E labels are converted to EAN 13 when adding AIM IDs.
 b. ISBN (X with a 0 modifier character)

Figure 19. AIM ID

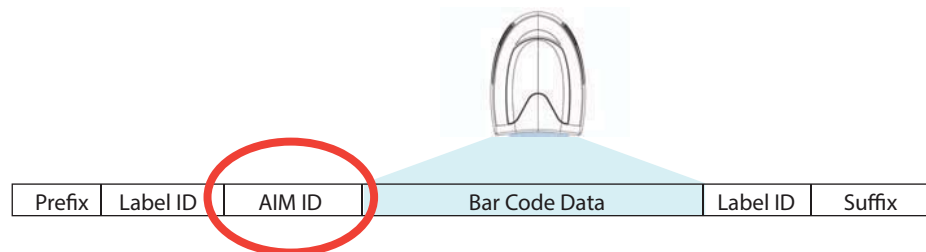

Label ID

A Label ID is a customizable code of up to three ASCII characters (each can be one of hex 0x01–0xFF), used to identify a bar code (symbology) type. It can be appended previous to or following the transmitted bar code data depending upon how this option is enabled. This feature provides options for configuring custom Label IDs as a pre-loaded set or individually per symbology (see "Label ID: Set Individually Per Symbology"). If you wish to program the scanner to always include an industry standard label identifier for ALL symbology types, see "Global AIM ID".

Label ID: Pre-loaded Sets

The following table lists the pre-loaded label ID sets for the USA and Europe.

Table 21. Label ID Pre-loaded Sets

Symbology	USA Label ID set		EU Label ID set	
	ASCII character	Hex value	ASCII character	Hexadecimal value
ABC Codabar	S	530000	S	530000
CODABAR	%	250000	R	520000
Code 39 CIP	Y	590000	Y	590000
Code 93	&	260000	U	550000
CODE11	CE	434500	b	620000
CODE128	#	230000	T	540000
CODE32	A	410000	X	580000
CODE39	*	2A0000	V	560000
CODE93	&	260000	U	550000
DATALOGIC 20F5	s	730000	s	730000
EAN13	F	460000	B	420000
EAN13 P2	F	460000	L	4C0000
EAN13 P5	F	460000	M	4D0000
EAN8	FF	464600	A	410000
EAN8 P2	FF	464600	J	4A0000
EAN8 P5	FF	464600	K	4B0000
FOLLETT 20F5	O	4F0000	O	4F0000
GS1 DATABAR EXPANDED	RX	525800	t	740000
GS1 DATABAR LIMITED	RL	524C00	v	760000
GS1 DATABAR OMNIDIRECTIONAL	R4	523400	u	750000
GS1-128		000000	k	6B0000

Symbology	USA Label ID set		EU Label ID set	
I2OF5	i	690000	N	4E0000
IATA	IA	494100	&	260000
Industrial 2 of 5	W	570000	W	570000
Interleaved 2 of 5	e	650000	e	650000
ISBN	l	490000	@	400000
ISBT128	f	660000	f	660000
ISSN	n	6E0000	n	6E0000
MSI	@	400000	Z	5A0000
S25	s	730000	P	500000
UPCA	A	410000	C	430000
UPCA P2	A	410000	F	460000
UPCA P5	A	410000	G	470000
UPCE	E	450000	D	440000
UPCE P2	E	450000	H	480000
UPCE P5	E	450000	I	490000
OCR-A	o	6F0000	\$o	246F00
OCR-B	o	6F0000	\$p	247000
MICR	o	6F0000	\$m	246D00

Label ID: Set Individually Per Symbology

To configure a Label ID individually for a single symbology:

1. Scan the ENTER/EXIT bar code.
2. Select Label ID position as either BEFORE (Enable as Prefix) or AFTER (Enable as suffix) by scanning the appropriate bar code in the section "Label ID Control". Reference Figure 20 for Label ID positioning options if multiple identification features are enabled.
3. Scan a bar code to select the symbology for which you wish to configure a custom Label ID from the section Label ID Symbology Selection.
4. Determine the desired character(s) (you may choose up to three) which will represent the Label ID for the selected symbology.
5. Turn to the [ASCII Chart](#) on the inside back cover of this manual and find the equivalent hex digits associated with your choice of Label ID. For example, if you wish to select an equal sign (=) as a Label ID, the chart indicates its associated hex characters as 3D. Turn to [Keypad](#) and scan the bar codes representing the hex characters determined. For the example given, the characters '3' and 'D' would be scanned. More examples of Label ID settings are provided in [Table 22](#).



NOTE

If you make a mistake before the last character, scan the **CANCEL** bar code to abort and not save the entry string. You can then start again at the beginning.

6. Scan the ENTER/EXIT bar code to exit Label ID entry.
7. Scan the ENTER/EXIT bar code once again to exit Programming Mode.

This completes the steps to configure a Label ID for a given symbology.

Figure 20. Label ID Position Options

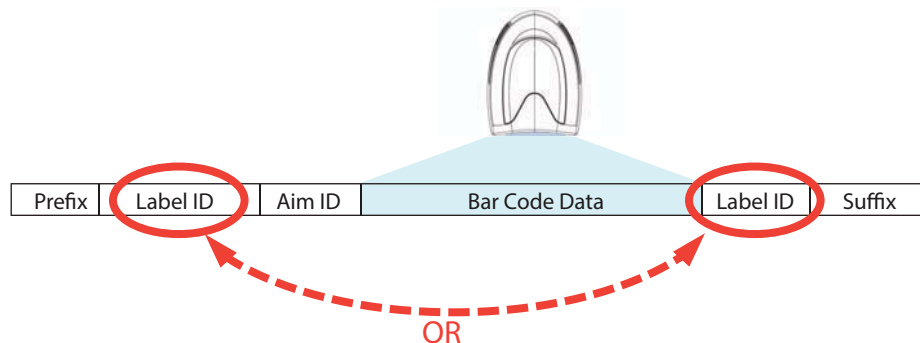

Label ID: Set Individually Per Symbology — continued

Table 22. Label ID Examples

STEP	ACTION	EXAMPLES			
1.	Scan the ENTER/EXIT bar code	(Scanner enters Programming Mode)			
2.	Determine placement of the Label ID characters BEFORE or AFTER with regard to scanned data using "Label ID Control"	Enable as Prefix	Enable as Suffix	Enable as Prefix	Enable as Suffix
3.	Scan the bar code selecting the symbology type you wish to designate label ID characters for using Label ID Symbology Selection	GS1 DataBar Omnidirectional	Code 39	Interleaved 2 of 5	Code 32
4.	Custom Label ID example (desired characters):	D B *	= C 3	+	P H
5.	Find hex equivalents from the ASCII table (inside back cover), then scan in these digits/characters using the bar codes in the section: Keypad. If you make a mistake before the last character, scan the CANCEL bar code to abort and not save the entry string. You can then start again at the beginning.	44 42 2A	3D 43 33	2B	50 48
6.	Scan the ENTER/EXIT bar code	(Scanner exits Label ID entry)			
7.	Scan the ENTER/EXIT bar code once again	(Scanner exits Programming Mode)			
Result:					
		DB*[bar code data]	[bar code data]=C3	+ [bar code data]	[bar code data]PH

Character Conversion

Character conversion is an eight byte configuration item. The eight bytes are 4 character pairs represented in hexadecimal ASCII values. The first character in the pair is the character that will be converted. The second character in the pair is the character to convert to. If the character to convert in a pair is FF, then no conversion is done.

For example, if you have the character conversion configuration item set to the following: 41423132FFFFFFFF

The first pair is 4142 or AB (41 hex is an ASCII capital A, 42 hex is an ASCII capital B) and the second pair is 3132 or 12 (31 hex is an ASCII 1, 32 is an ASCII 2). The other two pairs are FFFF and FFFF.

With the label, AB12BA21, it would look as follows after the character conversion: BB22BB22.

The A characters were converted to B characters and the 1 characters were converted to 2 characters. Nothing is done with the last two character pairs, since they are all FF.

To set Character Conversion:

1. Scan the ENTER/EXIT bar code.
2. Scan the bar code for "Character Conversion"
3. Determine the desired string. Sixteen positions must be determined as in the above example. Next, turn to the [ASCII Chart](#) on the inside back cover of this manual and find the equivalent hex digits needed to full-fill the string.
4. Turn to [Appendix D, Keypad](#) and scan the bar codes representing the hex characters determined in the previous step.
5. Scan the ENTER/EXIT bar code to exit Programming Mode.



NOTE

If less than the expected string of 16 characters are selected, scan the ENTER/EXIT bar code twice to accept the selections and exit Programming Mode.

Scanning Features

Good Read LED Duration

This feature specifies the amount of time that the Good Read LED remains on following a good read. The good read LED on time can be set within a range of 10 milliseconds to 2,550 milliseconds (0.001 to 2.55 seconds) in 100ms increments.

Follow these instructions to set this feature:

1. Determine the desired setting in milliseconds. A setting of 0 means that the good read LED stays on until the next time the trigger is pulled.
2. Divide the desired setting by 10 (setting is in 100ms increments). Pad the result with leading zeroes to yield three digits. For example: 0 = 000, 5 = 000, 20 = 020, etc.
3. Scan the ENTER/EXIT PROGRAMMING MODE bar code to enter Programming Mode.
4. Scan the bar code: SELECT GOOD READ LED DURATION SETTING.
5. Scan the appropriate three digits from the keypad in Appendix D, Keypad representing the duration which was determined in the steps above. You will hear a two-beep indication after the last character.



NOTE

If you make a mistake before the last character, scan the CANCEL bar code to abort and not save the entry string. You can then start again at the beginning.

6. Scan the ENTER/EXIT PROGRAMMING MODE bar code to exit Programming Mode.

This completes the procedure. See the following table for some examples of how to set this feature.

Table 23 - Good Read LED Duration Setting Example

STEP	ACTION	EXAMPLES			
1	Desired Setting	Good Read LED stays on until next trigger pull (00)	20ms	150ms	2550ms (2.55 sec.)
2	Divide by 10 (and pad with leading zeroes)	000	002	015	255
3	Scan ENTER/EXIT PROGRAMMING MODE				
4	Scan SELECT GOOD READ LED DURATION SETTING				
5	Scan Three Characters From Appendix D, Keypad	'0', '0' and '0'	'0', '0' and '2'	'0', '1' and '5'	'2', '5' and '5'
6	Scan ENTER/EXIT PROGRAMMING MODE				



RGB Good Read Color

Set the Good Read LED color.

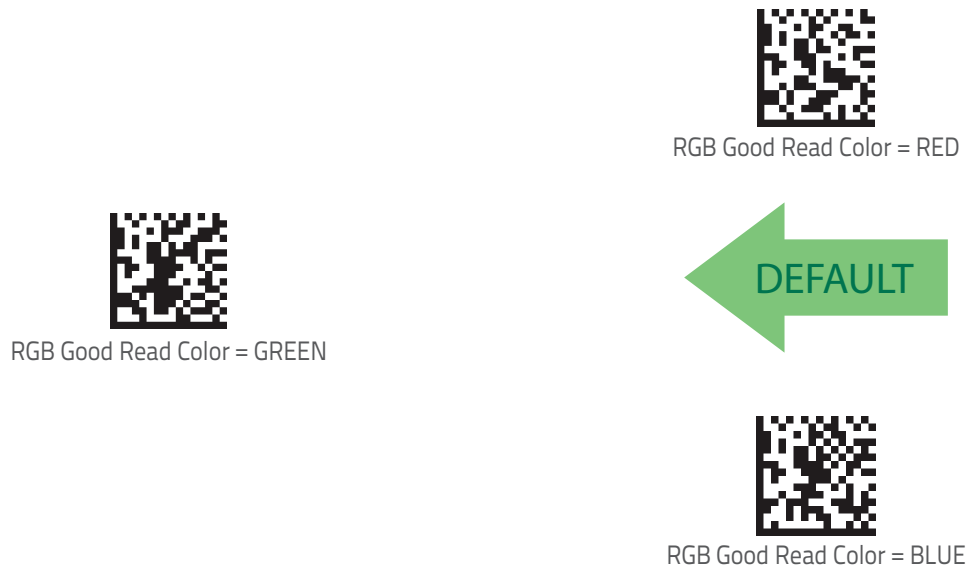

Scan Mode

Selects the scan operating mode for the reader. Selections are:

Trigger Single: When the trigger is pulled, scanning is activated until one of the following occurs:

- Stand Mode/Object Detection has elapsed
- a label has been read
- the trigger is released

This mode is associated with typical handheld reader operation: when the trigger is pulled, scanning starts and the product scans until the trigger is released, or a label is read, or the maximum Stand Mode/Object Detection has elapsed.

Trigger Hold Multiple : When the trigger is pulled, scanning starts and the product scans until the trigger is released or Stand Mode/Object Detection has elapsed. Reading a label does not disable scanning. **Double Read Timeout** prevents undesired multiple reads of the same label while in this mode.

Trigger Pulse Multiple: When the trigger is pulled, continuous scanning is activated until Stand Mode/Object Detection has elapsed or the trigger has been released and pulled again. **Double Read Timeout** prevents undesired multiple reads of the same label while in this mode.

Flashing: The reader flashes¹ on and off regardless of the trigger status. Flash rate is controlled by **Flash On Time** and **Flash Off Time**. When Flash is ON the reader reads continuously. When Flash is OFF scanning is deactivated.



Always On: No trigger pull is required to read a bar code. Scanning is continually on. **Double Read Timeout** prevents undesired multiple reads of the same label while in this mode.

Stand Mode/Object Detection: No trigger pull is required to read a bar code. Scanning turns on automatically when an item is placed in reader's field of view. While in a stand watch state, the reader illumination LED goes from dim to maximum bright.

¹Controlled by **Flash On Time**.

Scanning Active Time

This setting specifies the amount of time that the reader stays in scan ON state once the state is entered. The range for this setting is from 1 to 255 seconds in 1-second increments.

Follow these instructions to set this feature:

1. Determine the desired setting.
2. Pad the result with leading zeroes to yield three digits. For example: 0 = 000, 5 = 005, 20 = 020, etc.
3. Scan the ENTER/EXIT PROGRAMMING MODE bar code to enter Programming Mode.
4. Scan the bar code: SELECT SCANNING ACTIVE TIME SETTING.
5. Scan the appropriate three digits from the keypad in [Appendix D, Keypad](#) that represent the duration which was determined in the steps above. You will hear a two-beep indication after the last character.



NOTE

If you make a mistake before the last character, scan the CANCEL bar code to abort and not save the entry string. You can then start again at the beginning.

6. Scan the ENTER/EXIT PROGRAMMING MODE bar code to exit Programming Mode.

This completes the procedure. See the table below for examples of how to set this feature.

Table 24. Scanning Active Time Setting Examples

STEP	ACTION	EXAMPLES			
1	Desired Setting	1 Second	90 Sec. (1.5 min.)	180 Sec. (3 min.)	255 Seconds (4.25 min.)
2	Pad leading zero(es)	001	090	180	255
3	Scan ENTER/EXIT PROGRAMMING MODE				
4	Scan SELECT SCANNING ACTIVE TIME SETTING				
5	Scan Three Characters From Appendix D, Keypad	'0', '0' and '1'	'0', '9' and '0'	'1', '8' and '0'	'2', '5' and '5'
6	Scan ENTER/EXIT PROGRAMMING MODE				

Aiming Duration Time

Specifies the frame of time the aiming pointer remains on after decoding a label, when in trigger single mode. The range for this setting is from 1 to 255 seconds in 1-second increments.

Follow these instructions to set this feature:

1. Determine the desired setting.
2. Pad the result with leading zeroes to yield three digits. For example: 0 = 000, 5 = 005, 20 = 020, etc.
3. Scan the ENTER/EXIT PROGRAMMING MODE bar code to enter Programming Mode.
4. Scan the bar code: SELECT AIMING DURATION TIME SETTING.
5. Scan the appropriate three digits from the keypad in [Appendix D, Keypad](#), that represent the duration which was determined in the steps above. You will hear a two-beep indication after the last character.



NOTE

If you make a mistake before the last character, scan the CANCEL bar code to abort and not save the entry string. You can then start again at the beginning.

6. Scan the ENTER/EXIT PROGRAMMING MODE bar code to exit Programming Mode.

This completes the procedure. See [Table 25](#) for some examples of how to set this feature.

Table 25. Aiming Duration Time Setting Examples

STEP	ACTION	EXAMPLES			
1	Desired Setting	1 Second	90 Sec. (1.5 min.)	180 Sec. (3 min.)	255 Seconds (4.25 min.)
2	Pad leading zero(es)	001	090	180	255
3	Scan ENTER/EXIT PROGRAMMING MODE				
4	Scan SELECT AIMING DURATION TIME SETTING				
5	Scan Three Characters From Appendix D, Keypad	'0', '0' and '1'	'0', '9' and '0'	'1', '8' and '0'	'2', '5' and '5'
6	Scan ENTER/EXIT PROGRAMMING MODE				

Flash On Time

This feature specifies the ON time for the indicator LED while in Flash Mode. The selectable range is 100 to 9,900 milliseconds (0.1 to 9.9 seconds), in 100 millisecond increments.

Follow these instructions to set this feature.

1. Determine the desired setting in milliseconds.
2. Divide the desired setting by 100 (setting is in 100ms increments). Pad the result with leading zeroes to yield two digits. For example: 0 = 00, 5 = 05, 20 = 20, etc.
3. Scan the ENTER/EXIT PROGRAMMING MODE bar code to enter Programming Mode.
4. Scan the bar code: SELECT FLASH ON TIME SETTING.
5. Scan the appropriate two digits from the keypad in [Appendix D, Keypad](#) representing the duration which was determined in the steps above. You will hear a two-beep indication after the last character.



NOTE

If you make a mistake before the last character, scan the **CANCEL** bar code to abort and not save the entry string. You can then start again at the beginning.

6. Scan the ENTER/EXIT PROGRAMMING MODE bar code to exit Programming Mode.

This completes the procedure. See the table below for examples of how to set this feature.

Table 26. Flash On Time Setting Examples

STEP	ACTION	EXAMPLES			
1	Desired Setting	500ms	1,000ms (1 sec.)	5200ms (5.2 sec.)	9,900ms (9.9 sec.)
2	Divide by 100 (and pad with leading zeroes to yield two digits)	05	10	52	99
3	Scan ENTER/EXIT PROGRAMMING MODE				
4	Scan SELECT FLASH ON TIME SETTING				
5	Scan Two Characters From Appendix D, Keypad	'0' and '5'	'1' and '0'	'5' and '2'	'9' and '9'
6	Scan ENTER/EXIT PROGRAMMING MODE				

Flash Off Time

This feature specifies the OFF time for the indicator LED while in Flash Mode. The selectable range is 100 to 9,900 milliseconds (0.1 to 9.9 seconds), in 100 millisecond increments.

Follow these instructions to set this feature.

1. Determine the desired setting in milliseconds.
2. Divide the desired setting by 100 (setting is in 100ms increments). Pad the result with leading zeroes to yield two digits. For example: 0 = 00, 5 = 05, 20 = 20, etc.
3. Scan the ENTER/EXIT PROGRAMMING MODE bar code to enter Programming Mode.
4. Scan the bar code: SELECT FLASH OFF TIME SETTING.
5. Scan the appropriate two digits from the keypad in [Appendix D, Keypad](#), that represent the duration which was determined in the steps above. You will hear a two-beep indication after the last character.



NOTE

If you make a mistake before the last character, scan the CANCEL bar code to abort and not save the entry string. You can then start again at the beginning.

6. Scan the ENTER/EXIT PROGRAMMING MODE bar code to exit Programming Mode.

This completes the procedure. See the table below for examples of how to set this feature.

Table 27. Flash Off Time Setting Examples

STEP	ACTION	EXAMPLES			
1	Desired Setting	500ms	1,000ms (1 sec.)	5200ms (5.2 sec.)	9,900ms (9.9 sec.)
2	Divide by 100 (and pad with leading zeroes to yield two digits)	05	10	52	99
3	Scan ENTER/EXIT PROGRAMMING MODE				
4	Scan SELECT FLASH OFF TIME SETTING				
5	Scan Two Characters From Appendix D, Keypad	'0' and '5'	'1' and '0'	'5' and '2'	'9' and '9'
6	Scan ENTER/EXIT PROGRAMMING MODE				

RF Features

Automatic Configuration Update

When this feature is enabled, the base station and reader will keep their configurations synchronized. If a reader's configuration is altered by reading programming labels, this change is automatically transferred and updated in a linked base station. Likewise, if the base station's configuration is changed using the configuration utility or by host commands, then the reader's configuration will automatically be updated if this feature is enabled.

RF Address Stamping

Source Radio Address Delimiter Character

This option specifies the delimiter character to be placed between the label data and radio address when address stamping is enabled.



This feature only applies if "Source Radio Address Transmission" is enabled.

NOTE

Follow these instructions to select the delimiter character:

1. Determine the desired character, then find its hexadecimal equivalent on the ASCII Chart on the inside back cover. A setting of 00 specifies no delimiter character.
2. Scan the ENTER/EXIT PROGRAMMING MODE bar code to enter Programming Mode.
3. Scan the bar code: SET SOURCE RADIO ADDRESS DELIMITER CHARACTER.
4. Scan the appropriate two digits from the keypad in [Appendix D, Keypad](#), that represent the hexadecimal characters which were determined in the steps above. You will hear a two-beep indication after the last character.



If you make a mistake before the last character, scan the CANCEL bar code to abort and not save the entry string. You can then start again at the beginning.

NOTE

5. Scan the ENTER/EXIT PROGRAMMING MODE bar code to exit.

Table 28. Source Radio Address Delimiter Character Setting Examples

STEP	ACTION	EXAMPLES			
1	Desired Setting	No delimiter character	, (comma)	- (dash)	/ (slash)
2	Scan ENTER/EXIT PROGRAMMING MODE				
3	Scan SET SOURCE RADIO ADDRESS DELIMITER CHARACTER				
4	Scan Two Characters From Appendix D, Keypad	'0' and '0'	'2' and 'C'	'2' and 'D'	'2' AND 'F'
5	Scan ENTER/EXIT PROGRAMMING MODE				

Symbologies

Set Length

Length Control allows you to select either variable length decoding or fixed length decoding for the specified symbology.

Variable Length: For variable length decoding, a minimum and maximum length may be set.

Fixed Length: For fixed length decoding, two different lengths may be set.

Set Length 1

This feature specifies one of the bar code lengths for a given symbology. Length 1 is the minimum label length if in Variable Length Mode, or the first fixed length if in Fixed Length Mode.

Reference the 1D Symbologies section to view the selectable range (number of characters) for the symbology being set.

Follow these instructions to set this feature:

1. Determine the desired character length. Pad the number with leading zeroes to yield two digits. For example: 0 = 00, 5 = 05, 20 = 20, etc.
2. Scan the ENTER/EXIT PROGRAMMING MODE bar code to enter Programming Mode.
3. Scan the “Select Length 1 Setting” for the symbology being set.
4. Scan the appropriate two digits from the keypad in Appendix D, Keypad, that represent the length setting which was determined in the steps above. You will hear a two-beep indication after the last character.



NOTE

If you make a mistake before the last character, scan the CANCEL bar code to abort and not save the entry string. You can then start again at the beginning.

5. Scan the ENTER/EXIT PROGRAMMING MODE bar code to exit Programming Mode.

This completes the procedure. See the table below for examples of how to set this feature.

Table 30. Length 1 Setting Examples

STEP	ACTION	EXAMPLES			
1	Desired Setting	01 Character	07 Characters	52 Characters	74 Characters
2	Scan ENTER/EXIT PROGRAMMING MODE				
3	Scan SELECT LENGTH 1SETTING for the desired symbology				
4	Scan Two Characters From Appendix D, Keypad	'0' and '1'	'0' and '7'	'5' and '2'	'7' AND '4'
5	Scan ENTER/EXIT PROGRAMMING MODE				

Set Length 2

This feature specifies one of the bar code lengths for a given symbology. Length 2 is the maximum label length if in Variable Length Mode, or the second fixed length if in Fixed Length Mode.

Reference the *1D Symbologies* section to view the selectable range (number of characters) for the symbology being set. A setting of 00 specifies to ignore this length (only one fixed length).

Follow these instructions to set this feature:

1. Determine the desired character length. Pad the number with leading zeroes to yield two digits. For example: 0 = 00, 5 = 05, 20 = 20, etc.
2. Scan the ENTER/EXIT PROGRAMMING MODE bar code to enter Programming Mode.
3. Scan the “Select Length 2 Setting” for the symbology being set.
4. Scan the appropriate two digits from the keypad in *Appendix D, Keypad*, that represent the length setting which was determined in the steps above. You will hear a two-beep indication after the last character.



NOTE

If you make a mistake before the last character, scan the CANCEL bar code to abort and not save the entry string. You can then start again at the beginning.

5. Scan the ENTER/EXIT PROGRAMMING MODE bar code to exit Programming Mode.

This completes the procedure. See the table below for examples of how to set this feature.

Table 31. Length 2 Setting Examples

STEP	ACTION	EXAMPLES			
1	Desired Setting	00 (ignore second length)	07 Characters	52 Characters	74 Characters
2	Scan ENTER/EXIT PROGRAMMING MODE				
3	Scan SELECT LENGTH 2 SETTING				
4	Scan Two Characters From Appendix D, Keypad	'0' and '0'	'0' and '7'	'5' and '2'	'7' and '4'
5	Scan ENTER/EXIT PROGRAMMING MODE				

Appendix A

Technical Specifications

The table below contains Physical and Performance Characteristics, User Environment and Regulatory information. Table 34 provides Standard Cable Pinouts.

Table 32. Technical Specifications

Electrical Features	
Power Supply	5 VDC 4.5 - 14.0 VDCGBT/GM4500: 5V to 14V +/-5% in the Communication Port 5V to 14V +/-5% in the Aux Power Port NOTE: Aux Power Port is recommended when long cables are connected to Communication Port
Consumption (Typical)	Operating: <400 mA @ 5V <200 mA @ 12V Standby/Idle: <90 mA @ 5V 475 mA (PC host USB) 1150 mA (5V on Aux Power Port) 520 mA (12V on Aux Power Port) Gun Charging via micro USB: 480 mA (PC host port, no scan) 900 mA (wall adapter, no scan) 1160 mA (wall adapter, scan while charging)
Max. Scan Rate	50 frames/sec

Optical Features	
Optical Format	1/4"
Active Imager Size	3896 um (H) x 2453 um (V)
Active Pixels	1280 H x 800 V
Illumination System	LED source Warm White Emission (wavelength = 350 - 770 nm) Hyper Red Emission (wavelength = 660 nm, DGM model only) IEC 62471 Exempt Risk Group
Aiming System	RED laser source IEC 60825-1 Class 2 Radiation 1 mW Avg., Emitted wavelength 650 nm, 10ms pulse
Ambient Light	Up to 100,000 lux
Tilt Tolerance	0° - 360°
Pitch Tolerance	± 65°
Optical Features (continued)	
Skew Tolerance	± 65
Field of View	36° H x 23° V
PCS	minimum 15%

DOF - Depth of Field (Typical) ^a		
Symbology	SR	HD
Code 39	5 mil: 7.0 - 38.0 cm (2.7" - 14.9") 10 mil: 2.2 - 58.0 cm (0.8" - 22.8") 20 mil: FOV lim. - 110 cm (up to 43.3")	3 mil: 5.0 - 15.0 cm (2.0" - 5.9") 5 mil: 0.5 - 25.0 cm (0.2" - 9.8") 10 mil: 0.5 - 45.0 cm (0.2" - 17.7")
EAN13	7.5 mil: 9.0 - 30.0 cm (3.5" - 11.8") 13 mil: 1.0 - 71.0 cm (0.4" - 27.9")	7.5 mil: 2.0 - 23.5 cm (0.8" - 9.2") 13 mil: 1.0 - 40.0 cm (0.4" - 15.7")
PDF417	6.6 mil: 6.5 - 24.0 cm (2.6" - 9.4") 10 mil: 2.5 - 41.0 cm (1.0" - 16.1") 15 mil: 2.3 - 65.0 cm (0.9" - 25.6")	4 mil: 3.0 - 12.0 cm (1.2" - 4.7") 6.6 mil: 0.5 - 23.5 cm (0.2" - 9.2") 10 mil: 0.5 - 31.0 cm (0.2" - 12.2")
Datamatrix	10 mil: 5.5 - 27.0 cm (2.2" - 10.6") 15 mil: 2.8 - 41.0 cm (1.1" - 16.1")	5 mil: 5.5 - 9.0 cm (2.2" - 3.5") 10 mil: 0.2 - 27.0 cm (0.1" - 10.6")
Max Resolution	1D Min = 4 mils PDF417 Min = 5 mils Datamatrix Min = 7.5 mils	1D Min = 3 mils PDF417 Min = 3 mils Datamatrix Min = 4 mils

^a. 13 mils DOF based on EAN. All other 1D codes are Code 39. All labels grade A, typical environmental light, 20°C, label inclination 10°

Environmental Features	
Operating Temperature	0 °C to + 50 °C (+32° F to +122 °F)
Storage Temperature	-40 °C to + 70 °C (-40 ° F to +158 °F)
Humidity	95% non condensing
Drop Resistance	IEC 68-2-32 Tested 1.8 m (6 ft)
ESD Protection	16 KV
Protection Class	IP52
Weight (without cable)	161 g (5.7 oz.) With integrated stand approx. 374 g (13.2 oz.)

Decode Capability
<p>1D Bar Codes</p> <p>UPC/EAN/JAN (A, E, 13, 8); UPC/EAN/JAN (including P2 /P5); UPC/EAN/JAN (including; ISBN / Bookland & ISSN); UPC/EAN Coupons; Code 39 (including full ASCII); Code 39 Trioptic; Code39 CIP (French Pharmaceutical); LOGMARS (Code 39 w/ standard check digit enabled); Danish PPT; Code 32 (Italian Pharmacode 39); Code 128; Code 128 ISBT; Interleaved 2 of 5; Standard 2 of 5; Interleaved 2 of 5 CIP (HR); Industrial 2 of 5; Discrete 2 of 5; Matrix 2 of 5; IATA 2of5 Air cargo code; Code 11; Codabar; Codabar (NW7); ABC Codabar; EAN 128; Code 93 ; MSI; PZN; Plessey; Anker Plessey; GS1 DataBar Omnidirectional; GS1 DataBar Limited; GS1 DataBar Expanded; GS1 DataBar Truncated; DATABAR Expanded Coupon.</p>
<p>2D / Stacked Codes</p> <p>The scanner is capable of decoding the following symbologies using multiple frames (i.e. Multi-Frame Decoding):</p> <p>Datamatrix; Inverse Datamatrix; Datamatrix is configurable for the following parameters: Normal or Inverted; Square or Rectangular Style; Data length (1 - 3600 characters); Maxicode; QR Codes (QR, Micro QR and Multiple QR Codes); Aztec; Postal Codes - (Australian Post; Japanese Post; KIX Post; Planet Code; Postnet; Royal Mail Code (RM45CC); Intelligent Mail Barcode (IMB); Sweden Post; Portugal Post); LaPoste A/R 39; PDF-417; MacroPDF; Micro PDF417; GS1 Composites (1 - 12); French CIP13^a; GS1 DataBar Stacked; GS1 DataBar Stacked Omnidirectional; GS1 DataBar Expanded Stacked; GS1 Databar Composites; GS1 DotCode; Chinese Sensible Code; Inverted 2D codes^b.</p> <p>^aIt is acceptable to handle this with ULE</p> <p>^bThe SW can apply the Normal/Reverse Decoding Control to the following symbologies: Datamatrix, QR, Micro QR, Aztec and Chinese Sensible Code.</p>

LED and Beeper Indications

The imager’s beeper sounds and its illumination flashes or changes color to indicate various functions or errors on the reader. A “Green Spot” also lights to indicate a good read. The tables below list these indications.

Table 33. LED and Speaker Indications

Indication	LED	Beeper
Power-up	Upper LED flashes/blinks on power-up, however, this may be too rapid to view. With a USB interface, the LED blinks until enumeration with the host is completed.	Imager beeps four times at highest frequency and volume upon power-up.
Good Read	Upper green LED comes on for programmed time (default). LED behavior for this indication is configurable using configuration utility.	One beep at current frequency, volume, mono/bi-tonal setting upon a successful label scan.
ROM Failure	200ms on / 200ms off	Imager sounds one error beep at highest volume for 200 mS.
Limited Scanning Label Read	N/A	Imager 'chirps' six times at the highest frequency and current volume.
Imager Disabled	The LED blinks continuously 100mS on / 900 mS off	N/A

User Indications

Indication	3GL & Good Read LEDs	Buzzer
Power-up	OFF	Rising Beeps' Sequence
USB Enumeration Phase	250 ms ^a ON ↔ 250 ms OFF	OFF
USB Suspend	Depends on Power Cable and specific configurations	OFF
Idle	OFF	OFF
While Reading	OFF	OFF
Decode Done	Solid ON Programmable duration (1 s default)	Single Beep
Reader Disabled (POS) Communication with host not established	100 ms ON ↔ 900 ms OFF	OFF
Firmware Upgrade	250 ms ON ↔ 250 ms OFF	OFF
Host Download	250 ms ON ↔ 250 ms OFF	OFF
Enter Service Mode	No Effect	Beeps' Sequence
Label Programming	No Effect	Beep

^a 'ms" stands for milliseconds, equivalent to 1/1000th of a second

Programming Mode

The following indications ONLY occur when the scanner is in Programming Mode.

INDICATION	DESCRIPTION	LED	SPEAKER
Label Programming Mode Entry	A valid programming label has been scanned.	LED blinks continuously	Scanner sounds four low frequency beeps.
Label Programming Mode Rejection of Label	A label has been rejected.	N/A	Scanner sounds three times at lowest frequency & current volume.
Label Programming Mode Acceptance of Partial Label	In cases where multiple labels must be scanned to program one feature, this indication acknowledges each portion as it is successfully scanned.	N/A	Scanner sounds one short beep at highest frequency & current volume.
Label Programming Mode Acceptance of Programming	Configuration option(s) have been successfully programmed via labels and the scanner has exited Programming Mode.	N/A	Scanner sounds one high frequency beep and 4 low frequency beeps followed by reset beeps.
Label Programming Mode Cancel Item Entry	Cancel label has been scanned.	N/A	Scanner sounds two times at low frequency and current volume.

Troubleshooting

Problem	Possible Cause	Possible Solutions
Nothing happens when the scan button is pulled.	No power to the imager.	Check system power. Ensure power supply is connected.
	Interface or power cables are loose.	Ensure all cable connections are secure.
LED comes on, but bar code does not decode.	Imager not programmed for correct bar code type.	Ensure imager is programmed to read the type of bar code scanned. Refer to the PRG for more information.
	Bar code label is unreadable.	Check the label to ensure it is not defaced. Try scanning another bar code type.
	Distance between imager and bar code is incorrect.	Move imager closer to or further from the bar code.
Bar code is decoded but not transmitted to the host.	Imager not programmed for the correct host type.	Scan the appropriate host type bar code. Refer to the PRG for more information.

Standard Cable Pinouts

Figure 21 and Table 34 provide standard pinout information for the scanner's cable.

Figure 21. Standard Cable Pinouts

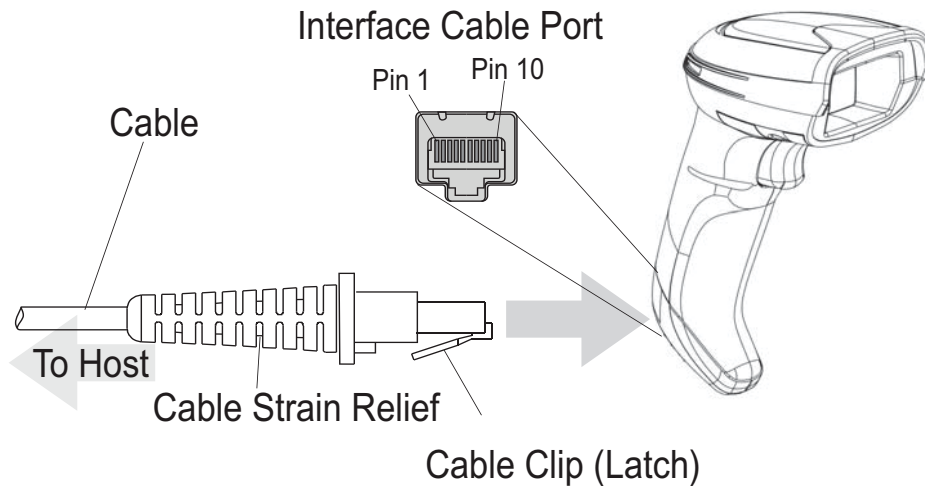

The signal descriptions in Table 34 apply to the connector on the scanner and are for reference only.

Table 34. Standard Cable Pinouts — Scanner Side

Pin	RS-232	USB	Keyboard Wedge
1	RTS (out)		
2		D+	CLKIN (KBD side)
3		D-	DATAIN (KBD side)
4	GND	GND	GND
5	RX		
6	TX		
7	VCC	VCC	VCC
8			CLKOUT (PC side)
9			DATAOUT (PC side)
10	CTS (in)		

NOTES

Appendix B

Standard Defaults

The most common configuration settings are listed in the “Default” column of the table below. Programming bar codes are provided for each parameter. A column has also been provided for recording of your preferred default settings for these same configurable features.

Table 35. Standard Defaults

Parameter	Default	Your Setting	
GLOBAL INTERFACE FEATURES			
Host Commands — Obey/Ignore	Obey		
USB Suspend Mode	Enable		
RS-232 ONLY			
Baud Rate	9600		
Data Bits	8 Data Bits		
Stop Bits	1 Stop Bit		
Parity	None		
Handshaking Control	RTS		
RS-232/USB-COM			
Intercharacter Delay	No Delay		
Beep On ASCII BEL	Disable		
Beep On Not on File	Enable		
ACK NAK Options	Disable		
ACK Character	'ACK'		
NAK Character	'NAK'		
ACK NAK Timeout Value	200 ms		
ACK NAK Retry Count	3 Retries		
ACK NAK Error Handling	Ignore Errors Detected		
Indicate Transmission Failure	Enable		

Standard Defaults

Parameter	Default	Your Setting	
Disable Character	'D'		
Enable Character	'E'		
KEYBOARD WEDGE			
Country Mode	U.S. Keyboard		
Keyboard Send Control Characters	00		
Wedge Quiet Interval	100 ms		
Intercode Delay	No Delay		
Caps Lock State	Caps Lock OFF		
Numlock	NumLock Key Unchanged		
USB Keyboard Speed	1 ms		
Keyboard Numeric Keypad	Standard Keys		
DATA FORMAT			
Global Prefix/Suffix	No Global Prefix Global Suffix = 0x0D (CR)		
Global AIM ID	Disable		
GS1-128 AIM ID	Enable		
Label ID: Pre-loaded Sets	EU Set		
Label ID: Pre-loaded Sets	Disable		
Case Conversion	Disable		
Character Conversion	No Char Conversion		
READING PARAMETERS			
Double Read Timeout	0.6 Second		
Power On Alert	Power-up Beep		
Good Read: When to Indicate	After Decode		
Good Read Beep Type	Mono		
Good Read Beep Frequency	High		

Parameter	Default	Your Setting	
Good Read Beep Length	80 ms		
Good Read Speaker Volume / Vibration	High		
Enable/Disable Good Read Indicator	300 ms		
SCANNING FEATURES			
Scan Mode	Trigger Single		
Stand Mode/Object Detection Sensitivity	Medium		
Stand Mode Indication	5 Seconds		
Flash On Time	OFF		
Flash On Time	10 = Flash is ON for 1 Second		
Flash Off Time	06 = Flash is OFF for 600ms		
CODE SELECTION - 1D SYMBOLOGIES			
Code EAN/UPC			
Coupon Control	Enable only UPCA coupon decoding		
UPC-A			
UPC-A Enable/Disable	Enable		
UPC-A Check Character Transmission	Send		
Expand UPC-A to EAN-13	Don't Expand		
UPC-A Number System Character Transmission	Transmit		
UPC-E			
UPC-E Enable/Disable	Enable		
UPC-E Check Character Transmission	Send		
Expand UPC-E to EAN-13	Don't Expand		
Expand UPC-E to UPC-A	Don't Expand		
UPC-E Number System Character Transmission	Transmit		
GTIN			
EAN 13	Disable		

Standard Defaults

Parameter	Default	Your Setting	
EAN 13 (Jan 13)			
EAN 13 Enable/Disable	Enable		
EAN 13 Check Character Transmission	Send		
EAN-13 Flag 1 Character	Transmit		
EAN-13 ISBN Conversion	Disable		
ISSN	Disable		
EAN 8			
EAN 8 Enable/Disable	Enable		
EAN 8 Check Character Transmission	Send		
Expand EAN 8 to EAN 13	Disable		
UPC/EAN Global Settings			
UPC/EAN Price Weight Check	Disable		
Add-Ons			
Optional Add-ons	Disable P2, P5 and P8		
Optional Add-On Timer	70 ms		
Code 39			
Code 39 Enable/Disable	Enable		
Code 39 Check Character Calculation	Disable		
Code 39 Check Character Transmission	Send		
Code 39 Start/Stop Character Transmission	Don't Transmit		
Code 39 Full ASCII	Disable		
Code 39 Quiet Zones	Small Quiet Zones on two sides		
Code 39 Length Control	Variable		
Code 39 Set Length 1	2		
Code 39 Set Length 2	50		
Code 32 (Italian Pharmaceutical Code)			
Code 32 Enable/Disable	Disable		
Code 32 Check Character Transmission	Don't Send		
Code 32 Start/Stop Character Transmission	Don't Transmit		

Parameter	Default	Your Setting	
Code 39 CIP (French Pharmaceutical Code)			
Code 39 CIP Enable/Disable	Disable		
Special Codes			
Code 128			
Code 128 Enable/Disable	Enable		
Expand Code 128 to Code 39	Don't Expand		
Code 128 Check Character Transmission	Don't Send		
Code 128 Function Character Transmission	Don't Send		
Code 128 Quiet Zones	Small Quiet Zones on two sides		
Code 128 Length Control	Variable		
Code 128 Set Length 1	1		
Code 128 Set Length 2	80		
GS1-128			
GS1-128 Enable	Transmit in Code 128 Data Format		
ISBT 128			
ISBT 128 Concatenation	Disable		
ISBT 128 Force Concatenation	Disable		
ISBT 128 Concatenation Mode	Static		
ISBT 128 Dynamic Concatenation Timeout	200 msec		
Interleaved 2 of 5			
I 2 of 5 Enable/Disable	Disable		
I 2 of 5 Check Character Calculation	Disable		
I 2 of 5 Check Character Transmission	Send		
I 2 of 5 Length Control	Variable		
I 2 of 5 Set Length 1	6		
I 2 of 5 Set Length 2	50		
Interleaved 2 of 5 CIP HR			
Interleaved 2 of 5 CIP HR Enable/Disable	Disable		

Standard Defaults

Parameter	Default	Your Setting	
Follett 2 of 5			
Follett 2 of 5 Enable/Disable	Disable		
Standard 2 of 5			
Standard 2 of 5 Enable/Disable	Disable		
Standard 2 of 5 Check Character Calculation	Disable		
Standard 2 of 5 Check Character Transmission	Send		
Standard 2 of 5 Length Control	Variable		
Standard 2 of 5 Length Control	8		
Standard 2 of 5 Set Length 2	50		
Industrial 2 of 5			
Industrial 2 of 5 Enable/Disable	Disable		
Industrial 2 of 5 Check Character Calculation	Disable		
Industrial 2 of 5 Check Character Transmission	Enable		
Industrial 2 of 5 Length Control	Variable		
Industrial 2 of 5 Set Length 1	1		
Industrial 2 of 5 Set Length 2	50		
Code IATA			
IATA Enable/Disable	Disable		
IATA Check Character Transmission	Enable		

Parameter	Default	Your Setting	
Codabar			
Codabar Enable/Disable	Disable		
Codabar Check Character Calculation	Don't Calculate		
Codabar Check Character Transmission	Send		
Codabar Start/Stop Character Transmission	Transmit		
Codabar Start/Stop Character Set	abcd/abcd		
Codabar Start/Stop Character Match	Don't Require Match		
Codabar Quiet Zones	Small Quiet Zones on two sides		
Codabar Length Control	Variable		
Codabar Set Length 1	3		
Codabar Set Length 2	50		
ABC Codabar			
ABC Codabar Enable/Disable	Disable		
ABC Codabar Concatenation Mode	Static		
ABC Codabar Dynamic Concatenation Timeout	200 msec		
ABC Codabar Force Concatenation	Disable		
Code 11			
Code 11 Enable/Disable	Disable		
Code 11 Check Character Calculation	Check C and K		
Code 11 Check Character Transmission	Send		
Code 11 Length Control	Variable		
Code 11 Set Length 1	4		
Code 11 Set Length 2	50		
GS1 DataBar Omnidirectional			
GS1 DataBar Omnidirectional Enable/Disable	Disable		
GS1 DataBar Omnidirectional GS1-128 Emulation	Disable		

Standard Defaults

Parameter	Default	Your Setting	
GS1 DataBar™ Expanded			
GS1 DataBar Expanded Enable/Disable	Disable		
GS1 DataBar Expanded GS1-128 Emulation	Disable		
	2D component not required		
GS1 DataBar Expanded Length Control	Variable		
GS1 DataBar Expanded Set Length 1	1		
GS1 DataBar Expanded Set Length 2	74		
GS1 DataBar™ Limited			
GS1 DataBar Limited Enable/Disable	Disable		
GS1 DataBar Limited GS1-128 Emulation	Disable		
Code 93			
Code 93 Enable/Disable	Disable		
Code 93 Check Character Calculation	Enable Check C and K		
Code 93 Check Character Transmission	Disable		
Code 93 Length Control	Variable		
Code 93 Set Length 1	1		
Code 93 Set Length 2	50		
Code 93 Quiet Zones	Small Quiet Zones on two sides		
MSI			
MSI Enable/Disable	Disable		
MSI Check Character Calculation	Enable Mod10		
MSI Check Character Transmission	Enable		
MSI Length Control	Variable		
MSI Set Length 1	1		
MSI Set Length 2	50		
MOTION FEATURES			
Motion Aiming Control	Enable		
Motion Sensitivity	Medium		
Motionless Timeout	2 seconds		

Default Exceptions

Table 36. Default Exceptions by Interface Type

Parameter	Default Exception
Interfaces: All Keyboard Wedge, USB Keyboard	
No unique settings	
Interface: RS232-WN	
Expand UPC-A to EAN-13	Enable
UPC-E Check Character Transmission	Disable
Parity	Odd Parity
Handshaking Control	RTS/CTS
Transmission Label ID Code	Prefix
GS1-128 AIM ID	Disable
UPCE Label ID Character(s)	C
EAN 8 Label ID Character(s)	B
EAN 13 Label ID Character(s)	A
Code ISBN Label ID Character(s)	A
Code 39 Label ID Character(s)	M
Interleaved 2of5 Label ID Character(s)	I
Code Standard 2/5 Label ID Character(s)	H
Codabar Label ID Character(s)	N
Code 128 Label ID Character(s)	K
GS1-128 Label ID Character(s)	P
Datalogic 2 of 5 Label ID Character(s)	H
ISBT 128 Label ID Character(s)	K
UPCE P2 Label ID Character(s)	C
UPCE/P5 Label ID Character(s)	C
UPCE/GS1-128 Label ID Character(s)	C

Standard Defaults

Parameter	Default Exception
EAN8/P2 Label ID Character(s)	B
EAN8/P5 Label ID Character(s)	B
EAN8/GS1-128 Label ID Character(s)	B
EAN13/P2 Label ID Character(s)	A
EAN13/P5 Label ID Character(s)	A
EAN13/GS1-128 Label ID Character(s)	A
GS1 DataBar 14 (Omnidirectional) Label ID Character(s)	E
GS1 DataBar Expanded Label ID Character(s)	E
GS1 DataBar Limited Label ID Character(s)	E
Character Conversion	CR to `
Interface: RS232-OPOS	
Baud Rate	115200 Baud
Transmission Label ID Code	Prefix
GS1-128 AIM ID	Disable
UPCA Label ID Character(s)	C
UPCE Label ID Character(s)	D
EAN 8 Label ID Character(s)	A
EAN 13 Label ID Character(s)	B
Code ISBN Label ID Character(s)	@
Code 39 Label ID Character(s)	V
Code 32 Label ID Character(s)	X
Interleaved 2of5 Label ID Character(s)	N
Code Standard 2/5 Label ID Character(s)	P
Codabar Label ID Character(s)	R
Code 11 Label ID Character(s)	b
Code 128 Label ID Character(s)	T
GS1-128 Label ID Character(s)	k
UPCA/P2 Label ID Character(s)	F
UPCA/P5 Label ID Character(s)	G

Parameter	Default Exception
UPCA/GS1-128 Label ID Character(s)	Q
UPCE/P2 Label ID Character(s)	H
UPCE/P5 Label ID Character(s)	I
EAN8/P2 Label ID Character(s)	J
EAN8/P5 Label ID Character(s)	K
EAN8/GS1-128 Label ID Character(s)	*
EAN13/P2 Label ID Character(s)	L
EAN13/P5 Label ID Character(s)	M
EAN13/GS1-128 Label ID Character(s)	#
GS1 DataBar 14 (Omnidirectional) Label ID Character(s)	u
GS1 DataBar Expanded Label ID Character(s)	t
GS1 DataBar Limited Label ID Character(s)	v

NOTES

Appendix C

Sample Bar Codes

The sample bar codes in this appendix are typical representations for their symbology types.

1D Bar Codes

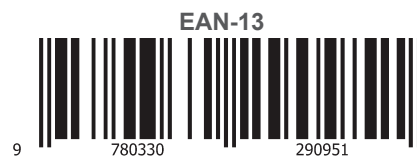

Code 128



Sample Bar Codes (continued)

Code 32



345678902

Codabar



13579

Code 93



ABCDEF

Code 11



12345

GS1 DataBar™ (RSS)



GS1 DataBar™ variants must be enabled to read the bar codes below (see "GS1 DataBar™ Omnidirectional").

GS1 DataBar™ Expanded Stacked



10293847560192837465019283746029478450366523

GS1 DataBar™ Expanded



1234890hjo9900mnb

GS1 DataBar™ Limited



08672345650916

GS1 DataBar™-14

GS1 DataBar™ Omnidirectional Truncated



55432198673467

GS1 DataBar™ Omnidirectional Stacked



90876523412674

GS1 DataBar™ Omnidirectional Stacked



78123465709811

2D Bar Codes

Aztec



Datamatrix



China Sensible Code



MaxiCode

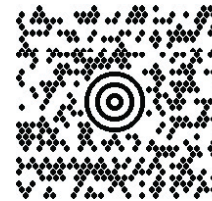

Test Message

PDF 417



ABCabc

Micro PDF 417



BV17453

QR Code



35900G9

Micro QR Code



123456

UCC Composite

(17) 050923 (10) ABC123



(01) 0 4012345 67890 1 1

Appendix D

Keypad

Use the bar codes in this appendix to enter numbers as you would select digits/characters from a keypad.



0



1



2



3



4



5



6



7



8



9



A



B



C



D



E



F

Appendix E

Scancode Tables

Control Character Emulation

Control character emulation selects from different scancode tables as listed in this appendix. Each of the control character sets below are detailed by interface type in the tables. These apply to Wedge and USB Keyboard platforms.

Control Character 00: Characters from 00 to 0x1F are sent as control character Ctrl+Keys, special keys are located from 0x80 to 0xA1.

Control Character 01: Characters from 00 to 0x1F are sent as control character Ctrl+Capital Key, special keys are located from 0x80 to 0xA1.

Control Character 02: Special keys are located from 00 to 0x1F and characters from 0x80 to 0xFE are intended as an extended ASCII table (Microsoft Windows Codepage 1252).

Single Press and Release Keys

In the following tables, Ar↓ means Alt right pressed and Ar↑ means Alt right released and so on. Definitions for other keys are Al (Alt left), Cr (Control Right) Cl (Control Left) Sh (shift). This method can be used for combining Alt, Control or Shift with other keys.

Example: Consider a Control character set to 00. If AltRight+A is required before sending a label to the host, it could be done by setting three Prefix keys in this way: 0x99 0x41 0x9A.

Interface Type PC AT PS/2 or USB-Keybaord

Table 37. Scancode Set When Control Character is 00 or 01

	x0	x1	x2	x3	x4	x5	x6	x7	x8	x9	xA	xB	xC	xD	xE	xF
0x	NULL C+@	SOH C(S)+A	STX C(S)+B	ETX C(S)+C	EOT C(S)+D	ENQ C(S)+E	ACK C(S)+F	BEL C(S)+G	BS	HT TAB	LF C(S)+J	VT C(S)+K	FF C(S)+L	CR Enter	SO C(S)+N	SI C(S)+O
1x	DLE C(S)+P	DC1 C(S)+Q	DC2 C(S)+R	DC3 C(S)+S	DC4 C(S)+T	NAK C(S)+U	SYN C(S)+V	ETB C(S)+W	CAN C(S)+X	EM C(S)+Y	SUB C(S)+Z	ESC Esc	FS C+1	GS C+]	RS C+^	US C(S)+_
2x	SP	!	"	#	\$	%	&	'	()	*	+	,	-	.	/
3x	0	1	2	3	4	5	6	7	8	9	:	;	<	=	>	?
4x	@	A	B	C	D	E	F	G	H	I	J	K	L	M	N	O
5x	P	Q	R	S	T	U	V	W	X	Y	Z	[\]	^	_
6x	,	a	b	c	d	e	f	g	h	i	j	k	l	m	n	o
7x	p	q	r	s	t	u	v	w	x	y	z	{		}	~	Del
8x	€	Sh↓	Sh↑	Ins	Ent (keyp)	F1	F2	F3	F4	F5	F6	F7	F8	F9	F10	F11
9x	F12	Home	End	Pg Up	Pg Dwn	↑	↓	←	→	Ar↓	Ar↑	Al↓	Al↑	Cl↓	Cl↑	Cr↓
Ax	Cr↑		'	<i>f</i>	"	...	†	‡	^	% ₀₀	Š	<	Š	<	Œ	
Bx	°	±	²	³	´	µ	¶	·	,	¹	º	»	¼	½	¾	¿
Cx	À	Á	Â	Ã	Ä	Å	Æ	Ç	È	É	Ê	Ë	Ì	Í	Î	Ï
Dx	Ð	Ñ	Ò	Ó	Ô	Õ	Ö	×	Ø	Ù	Ú	Û	Ü	Ý	Þ	ß
Ex	à	á	â	ã	ä	å	æ	ç	è	é	ê	ë	ì	í	î	ï
Fx	ð	ñ	ò	ó	ô	õ	ö	÷	ø	ù	ú	û	ü	ý	þ	ÿ

Extended characters (sky blue) are sent through dedicated keys (when available in the selected country mode) or by using an Alt Mode sequence.

Interface Type PC AT PS/2 or USB-Keyboard (continued)

Table 38. Scancode Set When Control Character is 02

	x0	x1	x2	x3	x4	x5	x6	x7	x8	x9	xA	xB	xC	xD	xE	xF
0x	Ar↓	Ar↑	Al↓	Al↑	Cl↓	Cl↑	Cr↓	Cr↑	BS	Tab	→	S+ Tab	Enter Keypd	Enter	Ins	Pg Up
1x	Pg Dwn	Home	←	↓	↑	F6	F1	F2	F3	F4	F5	ESC	F7	F8	F9	F10
2x	Space	!	“	#	\$	%	&	'	()	*	+	,	-	.	/
3x	0	1	2	3	4	5	6	7	8	9	:	;	<	=	>	?
4x	@	A	B	C	D	E	F	G	H	I	J	K	L	M	N	O
5x	P	Q	R	S	T	U	V	W	X	Y	Z	[\]	^	_
6x	,	a	b	c	d	e	f	g	h	i	j	k	l	m	n	o
7x	p	q	r	s	t	u	v	w	x	y	z	{		}	~	Del
8x	€	‘	’	f	”	…	†	‡	^	%	Š	<	Š	<	œ	
9x		‘	’	“	”	•	—	—	~	™	š	>	œ		ž	ÿ
Ax	NBSP	ı	ı	£	¤	¥	ı	§	¨	©	ª	«	¬	-	®	-
Bx	°	±	²	³	´	µ	¶	·	,	ı	°	»	¼	½	¾	¿
Cx	À	Á	Â	Ã	Ä	Å	Æ	Ç	È	É	Ê	Ë	Ì	Í	Î	Ï
Dx	Ð		Ò	Ó	Ô	Õ	Ö	×	Ø	Ù	Ú	Û	Ü	Ý	Þ	ß
Ex	à	á	â	ã	ä	å	æ	ç	è	é	ê	ë	ì	í	î	ï
Fx	ð	ñ	ò	ó	ô	õ	ö	÷	ø	ù	ú	û	ü	ý	þ	ÿ

Interface Type PC AT PS/2 Alt Mode or USB-Keyboard Alt Mode

Table 39. Scancode Set When Control Character is 00 or 01

	x0	x1	x2	x3	x4	x5	x6	x7	x8	x9	xA	xB	xC	xD	xE	Xf
0x	Alt+000	Alt+001	Alt+002	Alt+003	Alt+004	Alt+005	Alt+006	Alt+007	BS	HT TAB	Alt+010	Alt+011	Alt+012	CR Enter	Alt+014	Alt+015
1x	Alt+016	Alt+017	Alt+018	Alt+019	Alt+020	Alt+021	Alt+022	Alt+023	Alt+024	Alt+025	Alt+026	ESC Esc	Alt+028	Alt+029	Alt+030	Alt+031
2x	A+032	A+033	A+034	A+035	A+036	A+037	A+038	A+039	A+040	A+041	A+042	A+043	A+044	A+045	A+046	A+047
3x	A+048	A+049	A+050	A+051	A+052	A+053	A+054	A+055	A+056	A+057	A+058	A+059	A+060	A+061	A+062	A+063
4x	A+064	A+065	A+066	A+067	A+068	A+069	A+070	A+071	A+072	A+073	A+074	A+075	A+076	A+077	A+078	A+079
5x	A+080	A+081	A+082	A+083	A+084	A+085	A+086	A+087	A+088	A+089	A+090	A+091	A+092	A+093	A+094	A+095
6x	A+096	A+097	A+098	A+099	A+100	A+101	A+102	A+103	A+104	A+105	A+106	A+107	A+108	A+109	A+110	A+111
7x	A+112	A+113	A+114	A+115	A+116	A+117	A+118	A+119	A+120	A+121	A+122	A+123	A+124	A+125	A+126	A+127
8x	€	Sh↓	Sh↑	Ins	Ent (keyp)	F1	F2	F3	F4	F5	F6	F7	F8	F9	F10	F11
9x	F12	Home	End	Pg Up	Pg Dwn	↑	↓	←	→	Ar↓	Ar↑	Al↓	Al↑	Cl↓	Cl↑	Cr↓
Ax	Cr↑	A+0161	A+0162	A+0163	A+0164	A+0165	A+0166	A+0167	A+0168	A+0169	A+0170	A+0171	A+0172	A+0173	A+0174	A+0175
Bx	A+0176	A+0177	A+0178	A+0179	A+0180	A+0181	A+0182	A+0183	A+0184	A+0185	A+0186	A+0187	A+0188	A+0189	A+0190	A+0191
Cx	A+0192	A+0193	A+0194	A+0195	A+0196	A+0197	A+0198	A+0199	A+0200	A+0201	A+0202	A+0203	A+0204	A+0205	A+0206	A+0207
Dx	A+0208	A+0209	A+0210	A+0211	A+0212	A+0213	A+0214	A+0215	A+0216	A+0217	A+0218	A+0219	A+0220	A+0221	A+0222	A+0223
Ex	A+0224	A+0225	A+0226	A+0227	A+0228	A+0229	A+0230	A+0231	A+0232	A+0233	A+0234	A+0235	A+0236	A+0237	A+0238	A+0239
Fx	A+0240	A+0241	A+0242	A+0243	A+0244	A+0245	A+0246	A+0247	A+0248	A+0249	A+0250	A+0251	A+0252	A+0253	A+0254	A+0255







Interface Type PC AT PS/2 Alt Mode or USB-KeyBoard Alt Mode (continued)

Table 40. Scancode Set When Control Character is 02

	x0	x1	x2	x3	x4	x5	x6	x7	x8	x9	xA	xB	xC	xD	xE	xF
0x	Ar↓	Ar↑	Al↓	Al↑	Cl↓	Cl↑	Cr↓	Cr↑	BS	Tab	→	S+ Tab	Enter Key/psd	Enter	Ins	Pg Up
1x	Pg Dwn	Home	←	↓	↑	F6	F1	F2	F3	F4	F5	ESC	F7	F8	F9	F10
2x	A+032	A+033	A+034	A+035	A+036	A+037	A+038	A+039	A+040	A+041	A+042	A+043	A+044	A+045	A+046	A+047
3x	A+048	A+049	A+050	A+051	A+052	A+053	A+054	A+055	A+056	A+057	A+058	A+059	A+060	A+061	A+062	A+063
4x	A+064	A+065	A+066	A+067	A+068	A+069	A+070	A+071	A+072	A+073	A+074	A+075	A+076	A+077	A+078	A+079
5x	A+080	A+081	A+082	A+083	A+084	A+085	A+086	A+087	A+088	A+089	A+090	A+091	A+092	A+093	A+094	A+095
6x	A+096	A+097	A+098	A+099	A+100	A+101	A+102	A+103	A+104	A+105	A+106	A+107	A+108	A+109	A+110	A+111
7x	A+112	A+113	A+114	A+115	A+116	A+117	A+118	A+119	A+120	A+121	A+122	A+123	A+124	A+125	A+126	A+127
8x	A+0128	A+0129	A+0130	A+0131	A+0132	A+0133	A+0134	A+0135	A+0136	A+0137	A+0138	A+0139	A+0140	A+0141	A+0142	A+0143
9x	A+0144	A+0145	A+0146	A+0147	A+0148	A+0149	A+0150	A+0151	A+0152	A+0153	A+0154	A+0155	A+0156	A+0157	A+0158	A+0159
Ax	A+0160	A+0161	A+0162	A+0163	A+0164	A+0165	A+0166	A+0167	A+0168	A+0169	A+0170	A+0171	A+0172	A+0173	A+0174	A+0175
Bx	A+0176	A+0177	A+0178	A+0179	A+0180	A+0181	A+0182	A+0183	A+0184	A+0185	A+0186	A+0187	A+0188	A+0189	A+0190	A+0191
Cx	A+0192	A+0193	A+0194	A+0195	A+0196	A+0197	A+0198	A+0199	A+0200	A+0201	A+0202	A+0203	A+0204	A+0205	A+0206	A+0207
Dx	A+0208	A+0209	A+0210	A+0211	A+0212	A+0213	A+0214	A+0215	A+0216	A+0217	A+0218	A+0219	A+0220	A+0221	A+0222	A+0223
Ex	A+0224	A+0225	A+0226	A+0227	A+0228	A+0229	A+0230	A+0231	A+0232	A+0233	A+0234	A+0235	A+0236	A+0237	A+0238	A+0239
Fx	A+0240	A+0241	A+0242	A+0243	A+0244	A+0245	A+0246	A+0247	A+0248	A+0249	A+0250	A+0251	A+0252	A+0253	A+0254	A+0255

Microsoft Windows Codepage 1252

Windows-1252 is a character encoding of the Latin alphabet, used by default in the legacy components of Microsoft Windows in English and some other Western languages.

	00	01	02	03	04	05	06	07	08	09	0A	0B	0C	0D	0E	0F
00	<u>NUL</u> 0000	<u>STX</u> 0001	<u>SOT</u> 0002	<u>ETX</u> 0003	<u>EOF</u> 0004	<u>ENO</u> 0005	<u>ACK</u> 0006	<u>BEL</u> 0007	<u>BS</u> 0008	<u>HT</u> 0009	<u>LF</u> 000A	<u>VT</u> 000B	<u>FF</u> 000C	<u>CR</u> 000D	<u>SD</u> 000E	<u>SI</u> 000F
10	<u>DLE</u> 0010	<u>DC1</u> 0011	<u>DC2</u> 0012	<u>DC3</u> 0013	<u>DC4</u> 0014	<u>NAK</u> 0015	<u>SYN</u> 0016	<u>ETB</u> 0017	<u>CAN</u> 0018	<u>EM</u> 0019	<u>SUB</u> 001A	<u>ESC</u> 001B	<u>FS</u> 001C	<u>GS</u> 001D	<u>RS</u> 001E	<u>US</u> 001F
20	<u>SP</u> 0020	<u>!</u> 0021	<u>"</u> 0022	<u>#</u> 0023	<u>\$</u> 0024	<u>%</u> 0025	<u>&</u> 0026	<u>'</u> 0027	<u>(</u> 0028	<u>)</u> 0029	<u>*</u> 002A	<u>+</u> 002B	<u>,</u> 002C	<u>-</u> 002D	<u>.</u> 002E	<u>/</u> 002F
30	<u>0</u> 0030	<u>1</u> 0031	<u>2</u> 0032	<u>3</u> 0033	<u>4</u> 0034	<u>5</u> 0035	<u>6</u> 0036	<u>7</u> 0037	<u>8</u> 0038	<u>9</u> 0039	<u>:</u> 003A	<u>;</u> 003B	<u><</u> 003C	<u>=</u> 003D	<u>></u> 003E	<u>?</u> 003F
40	<u>@</u> 0040	<u>A</u> 0041	<u>B</u> 0042	<u>C</u> 0043	<u>D</u> 0044	<u>E</u> 0045	<u>F</u> 0046	<u>G</u> 0047	<u>H</u> 0048	<u>I</u> 0049	<u>J</u> 004A	<u>K</u> 004B	<u>L</u> 004C	<u>M</u> 004D	<u>N</u> 004E	<u>O</u> 004F
50	<u>P</u> 0050	<u>Q</u> 0051	<u>R</u> 0052	<u>S</u> 0053	<u>T</u> 0054	<u>U</u> 0055	<u>V</u> 0056	<u>W</u> 0057	<u>X</u> 0058	<u>Y</u> 0059	<u>Z</u> 005A	<u>[</u> 005B	<u>\</u> 005C	<u>]</u> 005D	<u>^</u> 005E	<u>_</u> 005F
60	<u>`</u> 0060	<u>a</u> 0061	<u>b</u> 0062	<u>c</u> 0063	<u>d</u> 0064	<u>e</u> 0065	<u>f</u> 0066	<u>g</u> 0067	<u>h</u> 0068	<u>i</u> 0069	<u>j</u> 006A	<u>k</u> 006B	<u>l</u> 006C	<u>m</u> 006D	<u>n</u> 006E	<u>o</u> 006F
70	<u>p</u> 0070	<u>q</u> 0071	<u>r</u> 0072	<u>s</u> 0073	<u>t</u> 0074	<u>u</u> 0075	<u>v</u> 0076	<u>w</u> 0077	<u>x</u> 0078	<u>y</u> 0079	<u>z</u> 007A	<u>{</u> 007B	<u> </u> 007C	<u>}</u> 007D	<u>~</u> 007E	<u>DEL</u> 007F
80	<u>€</u> 20AC		<u>ƒ</u> 201A	<u>Œ</u> 201E	<u>•</u> 2025	<u>†</u> 2020	<u>‡</u> 2021	<u>ˆ</u> 02C5	<u>‰</u> 2030	<u>Š</u> 0160	<u><</u> 2039	<u>€</u> 0162		<u>ž</u> 017D		
90		<u>ˆ</u> 2078	<u>˚</u> 2019	<u>™</u> 201C	<u>”</u> 201D	<u>•</u> 2022	<u>–</u> 2013	<u>—</u> 2014	<u>ˆ</u> 02DC	<u>™</u> 2122	<u>Š</u> 0161	<u>›</u> 203A	<u>œ</u> 0163		<u>ž</u> 017E	<u>Ÿ</u> 0178
A0	<u>NEST</u> 00AD	<u>ı</u> 00A1	<u>ı</u> 00A2	<u>£</u> 00A3	<u>¤</u> 00A4	<u>¥</u> 00A5	<u>ı</u> 00A6	<u>§</u> 00A7	<u>ˆ</u> 00A8	<u>©</u> 00A9	<u>ª</u> 00AA	<u>«</u> 00AB	<u>¬</u> 00AC	<u>–</u> 00AD	<u>®</u> 00AE	<u>¯</u> 00AF
B0	<u>°</u> 00B0	<u>±</u> 00B1	<u>²</u> 00B2	<u>³</u> 00B3	<u>´</u> 00B4	<u>µ</u> 00B5	<u>¶</u> 00B6	<u>·</u> 00B7	<u>¸</u> 00B8	<u>¹</u> 00B9	<u>º</u> 00BA	<u>»</u> 00BB	<u>¼</u> 00BC	<u>½</u> 00BD	<u>¾</u> 00BE	<u>¿</u> 00BF
C0	<u>À</u> 00C0	<u>Á</u> 00C1	<u>Â</u> 00C2	<u>Ã</u> 00C3	<u>Ä</u> 00C4	<u>Å</u> 00C5	<u>Æ</u> 00C6	<u>Ç</u> 00C7	<u>È</u> 00C8	<u>É</u> 00C9	<u>Ê</u> 00CA	<u>Ë</u> 00CB	<u>Ì</u> 00CC	<u>Í</u> 00CD	<u>Î</u> 00CE	<u>Ï</u> 00CF
D0	<u>Ð</u> 00D0	<u>Ñ</u> 00D1	<u>Ò</u> 00D2	<u>Ó</u> 00D3	<u>Ô</u> 00D4	<u>Õ</u> 00D5	<u>Ö</u> 00D6	<u>×</u> 00D7	<u>Ø</u> 00D8	<u>Ù</u> 00D9	<u>Ú</u> 00DA	<u>Û</u> 00DB	<u>Ü</u> 00DC	<u>Ý</u> 00DD	<u>Þ</u> 00DE	<u>ß</u> 00DF
E0	<u>à</u> 00E0	<u>á</u> 00E1	<u>â</u> 00E2	<u>ã</u> 00E3	<u>ä</u> 00E4	<u>å</u> 00E5	<u>æ</u> 00E6	<u>ç</u> 00E7	<u>è</u> 00E8	<u>é</u> 00E9	<u>ê</u> 00EA	<u>ë</u> 00EB	<u>ì</u> 00EC	<u>í</u> 00ED	<u>î</u> 00EE	<u>ï</u> 00EF
F0	<u>ø</u> 00F0	<u>ñ</u> 00F1	<u>ò</u> 00F2	<u>ó</u> 00F3	<u>ô</u> 00F4	<u>õ</u> 00F5	<u>ö</u> 00F6	<u>÷</u> 00F7	<u>ø</u> 00F8	<u>ù</u> 00F9	<u>ú</u> 00FA	<u>û</u> 00FB	<u>ü</u> 00FC	<u>ý</u> 00FD	<u>þ</u> 00FE	<u>ÿ</u> 00FF

ASCII Chart

ASCII Char.	Hex No.	ASCII Char.	Hex No.	ASCII Char.	Hex No.	ASCII Char.	Hex No.
NUL	00	SP	20	@	40	'	60
SOH	01	!	21	A	41	a	61
STX	02	"	22	B	42	b	62
ETX	03	#	23	C	43	c	63
EOT	04	\$	24	D	44	d	64
ENQ	05	%	25	E	45	e	65
ACK	06	&	26	F	46	f	66
BEL	07	'	27	G	47	g	67
BS	08	(28	H	48	h	68
HT	09)	29	I	49	i	69
LF	0A	*	2A	J	4A	j	6A
VT	0B	+	2B	K	4B	k	6B
FF	0C	,	2C	L	4C	l	6C
CR	0D	-	2D	M	4D	m	6D
SO	0E	.	2E	N	4E	n	6E
SI	0F	/	2F	O	4F	o	6F
DLE	10	0	30	P	50	p	70
DC1	11	1	31	Q	51	q	71
DC2	12	2	32	R	52	r	72
DC3	13	3	33	S	53	s	73
DC4	14	4	34	T	54	t	74
NAK	15	5	35	U	55	u	75
SYN	16	6	36	V	56	v	76
ETB	17	7	37	W	57	w	77
CAN	18	8	38	X	58	x	78
EM	19	9	39	Y	59	y	79
SUB	1A	:	3A	Z	5A	z	7A
ESC	1B	;	3B	[5B	{	7B
FS	1C	<	3C	\	5C		7C
GS	1D	=	3D]	5D	}	7D
RS	1E	>	3E	^	5E	~	7E
US	1F	?	3F	_	5F	DEL	7F