

USER MANUAL

LB512A-KIT-R2, LB532A-L-R2, LB532A-R-R2, LB532A-M-R2

INDUSTRIAL ETHERNET EXTENDERS

24/7 TECHNICAL SUPPORT AT 1.877.877.2269 OR VISIT BLACKBOX.COM

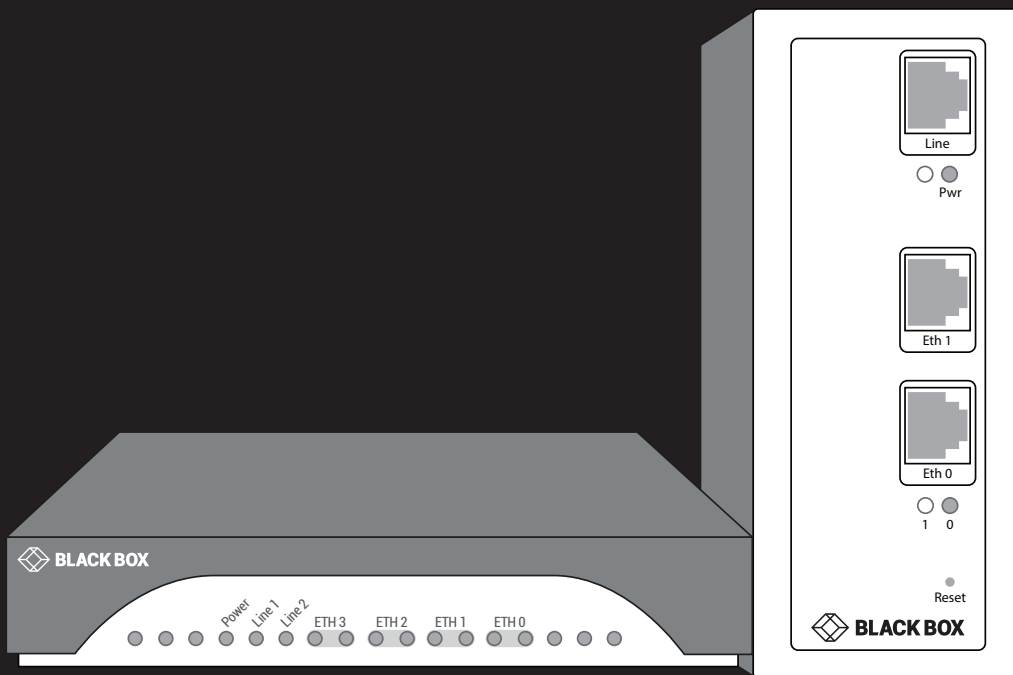

TABLE OF CONTENTS

SAFETY PRECAUTIONS	3
1. SPECIFICATIONS	4
2. OVERVIEW	5
2.1 Introduction.....	5
2.2 What's Included.....	5
2.3 Hardware Description.....	5
2.3.1 LB512A-R2 Front Panel.....	5
2.3.2 LB512A-R2 Back Panel.....	6
2.3.3 LB532A-R2 Front Panel.....	7
3. INSTALLATION	8
3.1 Connect the Line Interface.....	8
3.2 Connect the Ethernet Interface.....	8
3.3 Connect the Power Source.....	8
3.4 Status LEDs.....	9
4. CONFIGURATION	10
4.1 Options.....	10
4.2 DIP Switches.....	11
5. WIZARD INTERFACE	12
5.1 Connect with Web GUI.....	12
6. CLI OPERATION AND CONFIGURATION	16
6.1 Connect with SSH.....	16
6.2 Change the IP Address.....	16
6.3 Change the Default Username.....	16
6.4 Save the Configuration.....	16
6.5 DSL Commands.....	16
APPENDIX A. REGULATORY INFORMATION	19
A.1 EMC.....	19
A.2 Safety.....	19
A.3 PSTN Regulatory.....	19
A.4 FCC Part 68 (ACTA) Statement.....	19
A.5 Industry Canada Notice.....	20
A.6 Radio and TV Interference (FCC Part 15).....	20
A.7 EC Declaration of Conformity.....	20
APPENDIX B. DISCLAIMER/TRADEMARKS	21
B.1 Disclaimer.....	21
B.2 Trademarks Used in this Manual.....	21



SAFETY PRECAUTIONS

SAFETY PRECAUTIONS

WARNING: This device contains no user-serviceable parts. The equipment should be returned to Black Box for repairs, or repaired by a qualified service personnel.

IMPORTANT: This is a Class A device and is intended for use in a light industrial environment. It is not intended nor approved for use in an industrial or residential environment.

WARNING: The external power adapter should be a listed Limited Power Source. The outlet that is used to power the device should be within 10 feet (3 meters) of the device, should be easily accessible, and protected by a circuit breaker.

If an AC power adapter is used, ensure that the power cable used meets all applicable standards for the country in which it is to be installed, and that it is connected to a grounded wall outlet.

Hazardous network voltages are present in WAN ports regardless of whether power to the unit is ON or OFF. To avoid electric shock, use caution when near WAN ports. When detaching the cables, detach the end away from the device first.

Do not work on the system or connect or disconnect cables during periods of lightning activity.

CHAPTER 1: SPECIFICATIONS**TABLE 1-1. SPECIFICATIONS**

SPECIFICATION	DESCRIPTION
Protocol	LB512A-KIT-R2, LB532A-L-R2, LB532A-R-R2: Transparent to higher layer protocols; LB532A-M-R2: Transparent bridging (IEEE 802.1d), VLAN based QoS (802.1p/q), ARP, DHCP
Transmission Line	Single twisted pair (2-wire)
Line Rates	LB512A-KIT-R2: 192 kbps to 5.7 Mbps, selectable in 16 64 kbps increments up to 5.7 Mbps; LB532A-L-R2, LB532A-R-R2, LB532A-M-R2: 192 kbps to 15.3 Mbps, selectable in all 64 kbps increments starting at 192 kbps
LED Status Indicators	WAN: Link; LAN (Ethernet): Link/Act, Power
Line Coding	LB512A-KIT-R2: TC-PAM 16 for rates from 192 kbps to 2.3 Mbps; TC-PAM 32 for rates above 2.3 Mbps; LB532A-L-R2, LB532A-R-R2: TC-PAM 16 for rates up to 2.3 Mbps; TC-PAM 32 for rates above 2.3 Mbps; TC-PAM 64 for rates up to 11.4 Mbps, TC-PAM 128 for rates up to 15.3 Mbps; LB532A-M-R2: TC-PAM 16 for rates of 192 kbps to 2.3 Mbps; TC-PAM 32 for rates above 2.3 Mbps; TC-PAM 64 for rates above 5.7 Mbps, TC-PAM 128 for rate sup to 11.4 Mbps
Connectors	LB512A-KIT-R2: RJ-45 on copper line side and (4) 10/100 Ethernet, shrouded male IEC320 power connector; LB532A-L-R2, LB532A-R-R2: RJ-45 on copper line side and (2) 10/100 Ethernet, terminal block power connector; LB532A-M-R2: (2) RJ-45 on copper line side and (4) 10/100 Ethernet
Line Interface	Transformer coupled, 1500 VAC isolation
Management	LB512A-KIT-R2, LB532A-L-R2, LB532A-R-R2: DIP switch, Telnet console; LB532A-M-R2: DIP switch, HTTP, NTP, SMPv3, SYSLOG Client, CLI (Telnet, SSH, Console port), TFTP firmware upgrade, import/export config
MTBF	4.7 years
Power	LB512A-KIT-R2: External: 90 to 260 VAC, 50 to 60 Hz (universal input); LB532A-L-R2, LB532A-R-R2: External: 90 to 260 VAC, 50 to 60 Hz (universal input); Internal: 12 to +48 VDC (optional) (10 to 52 VDC); LB532A-M-R2: External: 90 to 260 VAC, 50 to 60 Hz (universal input) via terminal block; Internal: +12 to +48 VDC (optional)
Power Consumption	LB512A-KIT-R2, LB532A-L-R2, LB532A-R-R2: 0.8 A @ 5 V; LB532A-M-R2: 1 A @ 5 V, 5 W
Operating Temperature	LB512A-KIT-R2: 32 to 122° F (0 to 55° F); LB532A-L-R2, LB532A-R-R2, LB532A-M-R2: -40 to +185° F (-40 to +85° C)
Humidity	5 to 95%, noncondensing
Altitude	0 to 15,000 ft. (0 to 4600 m)
Enclosure	LB512A-KIT-R2: Plastic; LB532A-L-R2, LB532A-R-R2, LB532A-M-R2: Aluminum (IP40)
Dimensions	LB512A-KIT-R2: 1.52" H x 5" W x 4.7" D (3.9 x 12.7 x 10.6 cm); LB532A-L-R2, LB532A-R-R2, LB532A-M-R2: 5.62" H x 2.25" W x 4.66" D (14.27 x 5.7 x 11.8 cm)
Weight	LB512A-KIT-R2: 2 lb. (1 kg); LB532A-L-R2, LB532A-R-R2, LB532A-M-R2: 0.7 lb. (0.3 kg)
Compliance	FCC Part 15A, CE Mark per EMC directive 89/336/EEC, Low voltage directive 73/23/EEC



CHAPTER 2: OVERVIEW

2.1 INTRODUCTION

The Industrial Ethernet Extender is ideal for users or service providers who need high-speed dedicated network connections. Based on the ITU and ETSI G.SHDSL G.991.2 standard, the LB512A-KIT-R2, LB532A-R2 enables providers to extend their reach-and-range by delivering rate-adaptive nx64 symmetrical speeds up to 15.3 Mbps over a single pair of wires. If you need even more bandwidth, the LB512A-KIT-R2, LB532A-R2 can bond as many as two pairs (4 wires) for up to 30 Mbps.

Below is a list of available products:

- ◆ Industrial Ethernet Extender, consists of an Industrial Ethernet Extender, Local (LB532A-L-R2) and an Industrial Ethernet Extender, Remote (LB532A-R-R2)
- ◆ Industrial Ethernet Extender, Multidrop (LB532A-M-R2)
- ◆ Ethernet Extender Kit (LB512A-KIT-R2), consists of a Local and a Remote Extender

2.2 WHAT'S INCLUDED

Your package should include the following items. If anything is missing or damaged, contact Black Box Technical Support at 877-877-2269 or info@blackbox.com

- ◆ LB512A-KIT-R2, LB532A-R2 Ethernet Extender, 4-Port
- ◆ External power supply

2.3 HARDWARE DESCRIPTION

2.3.1 LB512A-R2 FRONT PANEL

Figure 2-1 shows the front panel of the Ethernet Extender. Table 2-1 describes its components.

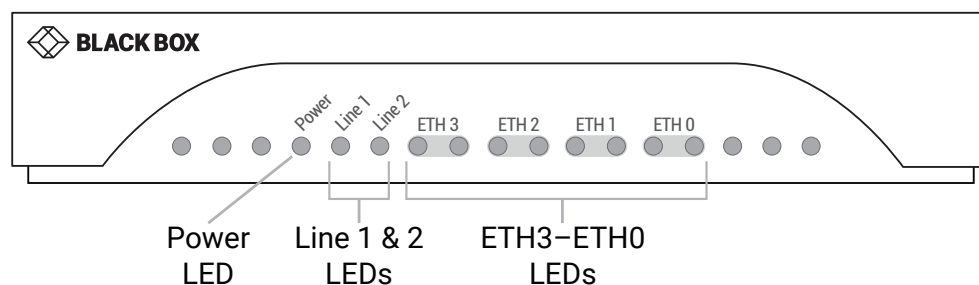

FIGURE 2-1. FRONT PANEL

CHAPTER 2: OVERVIEW

TABLE 2-1. FRONT PANEL COMPONENTS

COMPONENT IN FIGURE 2-1	DESCRIPTION
Power LED	LED turns on when power is supplied to the unit. LED is off when no power is supplied to the unit.
Line 1 and Line 2 LEDs	One LED for each port. OFF = Port is configured as down. ON = Port is in data mode. Blinking slowly = Port is in handshake mode (looking for a remote signal) Blinking fast = Port is in training mode (active communication with remote)
ETH3–ETH0 LEDs	ON = Port is linked OFF = Data is passing over the port

2.3.2 LB512A-R2 BACK PANEL

Figure 2-2 shows the back panel of the Ethernet Extender. Table 2-2 describes its components.

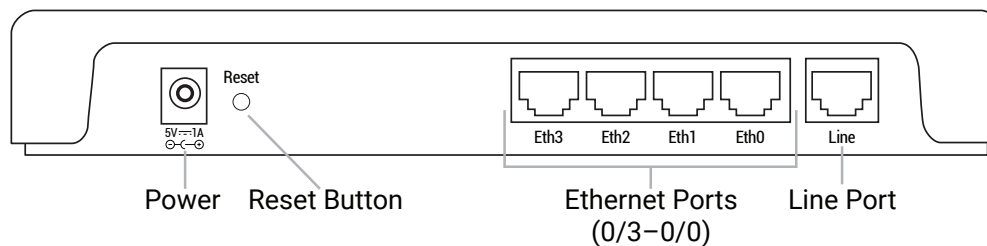

FIGURE 2-2. BACK PANEL

TABLE 2-2. BACK PANEL COMPONENTS

COMPONENT IN FIGURE 2-2	DESCRIPTION
Barrel connector	Links to 5-V, 1-A external power supply
Reset button	Press to reset the unit
(4) RJ-45 connectors	Ethernet ports (0/3 - 0/0)
(1) RJ-45 connector	Line port

CHAPTER 2: OVERVIEW

2.3.3 LB532A-R2 FRONT PANEL

Figure 2-3 shows the front panel of the Ethernet Extender. Table 2-1 describes its components.

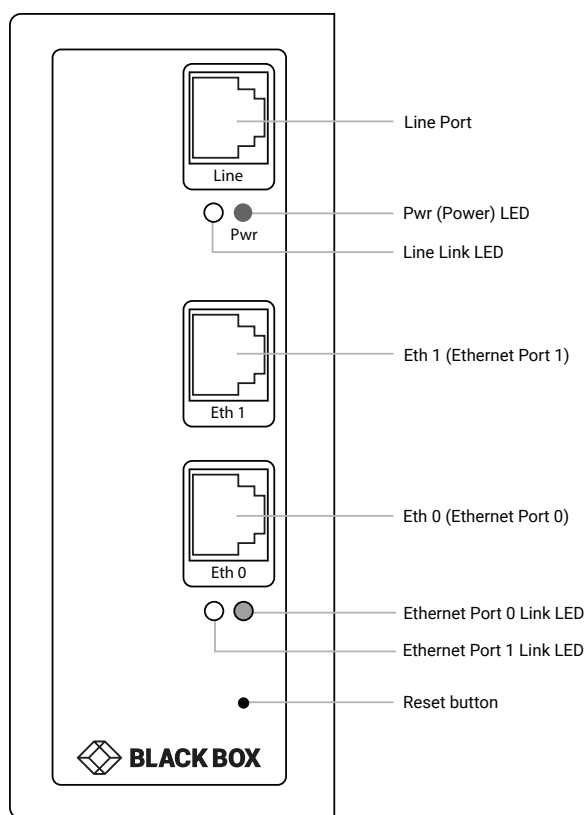

FIGURE 2-3. LB532A-R2 FRONT PANEL

TABLE 2-3. LB532A-R2 FRONT PANEL COMPONENTS

COMPONENT IN FIGURE 2-3	DESCRIPTION
RJ-45 connector	Line Port
Power LED	Lights when power is ON to the unit
Line Link LED	The Link LED glows solid while a link is established. While the link is training, it blinks once every second.
Eth 1 (Ethernet Port 1)	The Ethernet Link LED shows that there is an active physical connection to the console, or an active physical connection to an Ethernet device.
Eth 0 (Ethernet Port 0)	The Ethernet Link LED shows that there is an active physical connection to the console, or an active physical connection to an Ethernet device.
Ethernet Port 0 Link LED	ON = Port is linked OFF = Data is passing over the port
Ethernet Port 1 Link LED	ON = Port is linked OFF = Data is passing over the port
Reset button	Press to reset the unit

CHAPTER 3: INSTALLATION

3.1 CONNECT THE LINE INTERFACE

To function properly, the LB512A-KIT-R2, LB532A-R2 must be connected using a twisted-pair, unconditioned, dry, metal wire, between 19 (0.9-mm)

and 26 AWG (0.4-mm). Leased circuits that run through signal equalization equipment are not acceptable.

The Ethernet Extender has an RJ-45 interface jack (DSL) that conforms to the T568B standard. Any standard Category 5e cable can be used to directly connect two extenders. The Ethernet Extender has a two-wire interface.

Observe the signal/pin relationship on the LB512A-KIT-R2, LB532A-R2's Line interface jack for each pair in Figure 3-1.

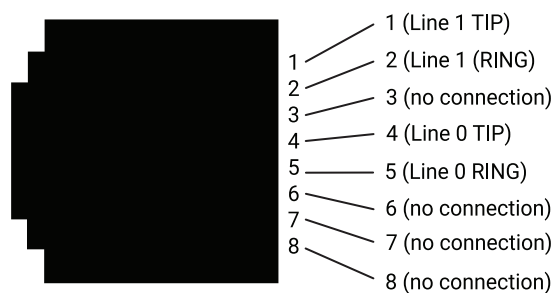

FIGURE 3-1. RJ-45 TWISTED-PAIR LINE INTERFACE

3.2 CONNECT THE ETHERNET INTERFACE

The Ethernet Extender has four unshielded RJ-45 auto-MDIX 10/100BASE-T interfaces. These are designed to connect directly to a 10/100BASE-TX network. You may connect this port to a hub or PC using a straight-through or crossover cable that is up to 328 feet (100 meters) long.

3.3 CONNECT THE POWER SOURCE

The Ethernet Extender does not have a power switch, so it powers up as soon as it is plugged in.

Connect the power via the barrel jack on the rear panel of the Extender. No configuration is necessary for the power supply.

CHAPTER 3: INSTALLATION

3.4 STATUS LEDS

The LEDs indicate the status of power, copper link, and Ethernet connections.

NOTE: When off, the LED indicators are clear; when lit, the indicators are yellow.

TABLE 3-1. FRONT PANEL LEDS

NUMBER IN FIGURE 2-1	LED INDICATOR	DESCRIPTION
1	Power LED	LED turns on when power is supplied to the unit. LED is off when no power is supplied to the unit.
2	On-site Pair LEDs	One LED for each port. OFF = Port is configured as down. ON = Port is in data mode. Blinking slowly = Port is in handshake mode (looking for a remote signal) Blinking fast - Port is in training mode (active communication with remote)
3	ETH3-ETH0 LEDs	ON = Port is linked OFF = Data is passing over the port

CHAPTER 4: CONFIGURATION

4.1 OPTIONS

The copper-link extenders are configured to work in pairs. If the factory-installed configuration needs to be adjusted, you can configure the device by using:

- ♦ DIP switches (while powered off)
- ♦ Web Wizards through HTTP access
- ♦ Command line interface (CLI) through SSH
- ♦ A combination of the above

For simple and common configurations, you may only need to use the DIP switches.

NOTE: If you will not have physical access to the device, it is best to leave the DIP switches disabled, as they will always override the other configuration access methods for some settings. This will be problematic if you need to change these settings remotely.

The factory installed configuration is shown below.

```
context ip ROUTER
    interface LAN
        ipaddress 192.168.200.11/24 #Remote units are set to 192.168.200.10/24
        ipaddress DHCP dhcp
context switch-group DEFAULT
    bind interface ROUTER LAN
    no shutdown
    interface ETHERNET _ 0 _ 0
    interface ETHERNET _ 0 _ 1
    interface ETHERNET _ 0 _ 2
    interface ETHERNET _ 0 _ 3
    interface DSL _ 0 _ 0
port ethernet 0 0
    bind switch-group DEFAULT ETHERNET _ 0 _ 0
    no shutdown
port ethernet 0 1
    bind switch-group DEFAULT ETHERNET _ 0 _ 1
    no shutdown
port ethernet 0 2
    bind switch-group DEFAULT ETHERNET _ 0 _ 2
    no shutdown
port ethernet 0 3
    bind switch-group DEFAULT ETHERNET _ 0 _ 3
    no shutdown
port line 0 0
    service-mode 2-wire
    mode local
    bind switch-group DEFAULT DSL _ 0 _ 0
    no shutdown
```



CHAPTER 4: CONFIGURATION

4.2 DIP SWITCHES

The DIP switches enable you to configure the Local/Remote and TCPAM/Rate preset. These settings are applied when the device powers on, and they cannot be changed while the device is powered on. Keep this in mind if you plan on adjusting these settings later remotely, as the DIP switch settings at boot will always take priority.

To disable the DIP switches:

1. Power off the device.
2. Set all DIP switches to OFF.

To enable the DIP switches:

1. Power off the device.
2. Set DIP switch #1 to Local or Remote. When connecting two Ethernet Extenders, one needs to be configured as Local, and the other Remote:
 - ♦ OFF = Local
 - ♦ ON = Remote
3. Set DIP switches #2–5 to a TCPAM/Rate Preset. When connecting two Ethernet Extenders back to back, their speeds should be configured to match.
4. Set DIP switches #6–8 to OFF. These are reserved for future use.

TABLE 4-1. DIP SWITCHES

#2	#3	#4	#5	TCPAM/RATE PRESET
ON	ON	ON	ON	TCPAM 16/32 Autorate
ON	ON	ON	OFF	TCPAM 64/128 Autorate
ON	ON	OFF	ON	TCPAM-4 192 kbps
ON	ON	OFF	OFF	TCPAM-4 2496 kbps
ON	OFF	ON	ON	TCPAM-8 192 kbps
ON	OFF	ON	OFF	TCPAM-8 5056 kbps
ON	OFF	OFF	ON	TCPAM-16 192 kbps
ON	OFF	OFF	OFF	TCPAM-16 3840 kbps
OFF	ON	ON	ON	TCPAM-32 768 kbps
OFF	ON	ON	OFF	TCPAM-32 5696 kbps
OFF	ON	OFF	ON	TCPAM-64 192 kbps
OFF	ON	OFF	OFF	TCPAM-64 12736 kbps
OFF	OFF	ON	ON	TCPAM-128 256 kbps
OFF	OFF	ON	OFF	TCPAM-128 15296 kbps
OFF	OFF	OFF	ON	Reserved
OFF	OFF	OFF	OFF	Disable DIP switches

CHAPTER 5: WIZARD INTERFACE

The Ethernet Extender provides a browser interface that allows you to configure and manage it. After you set up the IP address for the extender, you can access the Web interface applications directly in your Web browser by entering the configured IP address. You can then use your Web browser to list and manage configuration parameters from a PC.

NOTE: Earlier versions predating Internet Explorer 9.0 browser are not compatible with the LB512A-KIT-R2, LB532A-R2.

5.1 CONNECT WITH WEB GUI

1. Connect the Ethernet cable.
2. Connect the power supply.
3. Connect via web browser to the default address 192.168.200.10 or connect to 192.168.200.11 for 2-pack local units.
4. Log in with the default username admin without a password.

Once the network connection is established, you will be able to reach the LB512A-KIT-R2, LB532A-R2 Web GUI. Log into the Web GUI using the following credentials (see Figure 5-1).

- ♦ username: admin
- ♦ password: [blank, just press the Enter key]

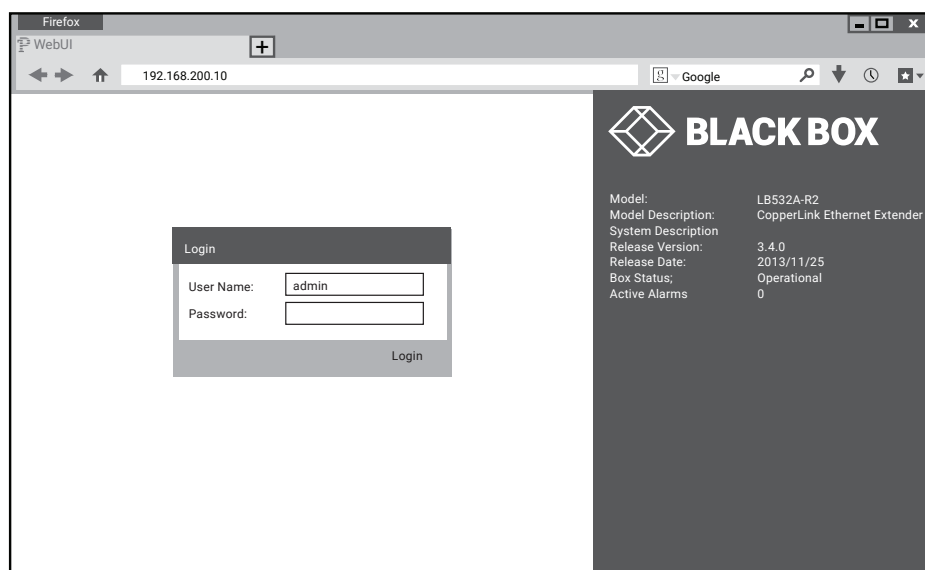

FIGURE 5-1. LOGIN SCREEN

The LB512A-KIT-R2, LB532A-R2 includes a Web Wizard within the GUI. The icon to the wizard is in the top right corner of your browser as shown in Figure 5-2.



FIGURE 5-2. WEB WIZARD HOME PAGE

CHAPTER 5: WIZARD INTERFACE

Once the wizard icon is selected, you will have the options of supported set-ups as shown in Figure 5-3. Click on LB512A-KIT-R2, LB532A-R2 Basic Setup.

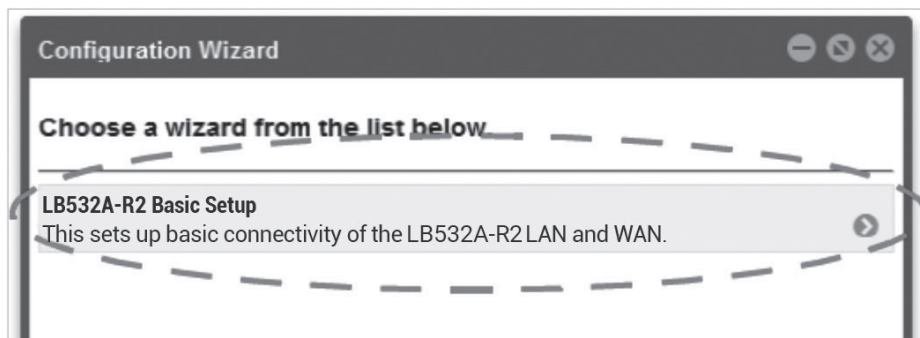

FIGURE 5-3. CHOOSE WIZARD

Clicking on the LB512A-KIT-R2, LB532A-R2 Basic Setup will bring up the most common configurations used on the Ethernet Extender. Figure 5-4 depicts options to configure the extender through the Basic Setup wizard.

A screenshot of the Configuration Wizard interface for the LB532A-R2 device. The title bar reads "Configuration Wizard" and "LB532A-R2". The interface is divided into three main sections: "User Address", "Management IP Setup", and "Line Setup".
- **User Address:** Includes fields for "Password:" and "Retype Password:".
- **Management IP Setup:** Includes radio buttons for "Management IP:" (Static, DHCP, Both), with "Both" selected. Below are fields for "IP Address:" (192 168 200 10), "Netmask:" (255 255 255 0), "Gateway:", and "Management VLAN ID:".
- **Line Setup:** Includes dropdown menus for "Line Type:" (Local), "Service Mode:" (2 wire), "Annex:" (B/G), and "Line Rate:" (Normal).
At the bottom right, there are buttons for "Preview" and "Save & Reboot".

FIGURE 5-4. BASIC SETUP

CHAPTER 5: WIZARD INTERFACE

User Access: (optional configuration) Users may change the password for the admin user.

- ◆ Management IP Setup:
 - Static: Create your own IP address, netmask and gateway (optional—the gateway is required for remote management).
 - DHCP: The LB512A-KIT-R2, LB532A-R2 management port will accept an IP address from a DHCP server.
 - Both: This choice will assign two IP addresses (one static and one DHCP to the management port)
 - Management VLAN ID: (Optional) define a VLAN ID for management traffic.
- ◆ Line Setup: This where you can manually set your copper link line options.

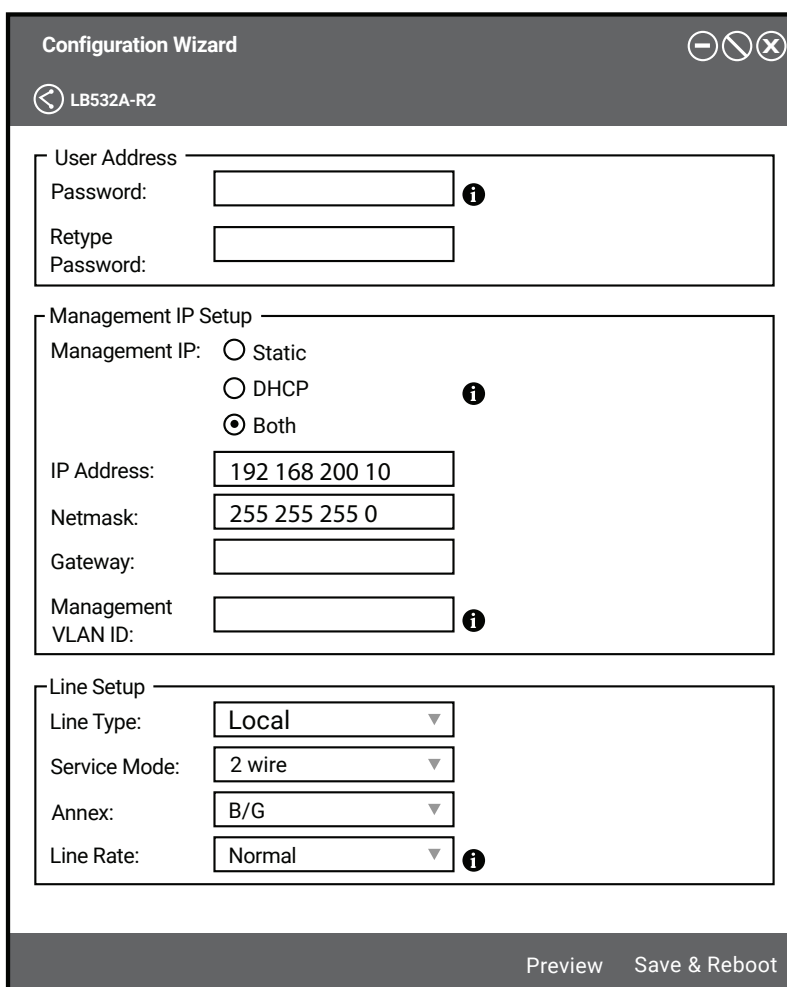
NOTE: The copper link Ethernet Extenders by default are set to plug-and-play operation.

- Line Type (Local or Remote): This will set the extender as Local or Remote. Local is typically used at the network, Remote is typically used at the remote device or remote network. LB512A-KIT-R2 is already configured as one Local and one Remote.
- Service Mode: Configures the number of pairs (wires) you want to use. The extender will default to the maximum number of wires available on your Extender (2-wire).
- Annex: Consult Black Box Technical Support at 877-877-2269 or info@blackbox.com before changing this setting.
- Line Rate Configuration: This will increase the potential line rate of the extender. The extender defaults to automatically select the optimal rate based on the distance (adaptive).

NOTE: There are two modes: Normal (TCPAM16|32) and Extended (TCPAM64|128). Selecting the Extended mode will double the bandwidth, but will reduce the reach (distance) by half. Default is normal.

On the bottom right corner of the Basic Configuration wizard page, you can preview configurations and reboot. Figure 8 depicts what you can expect to see if you click on the preview tab.

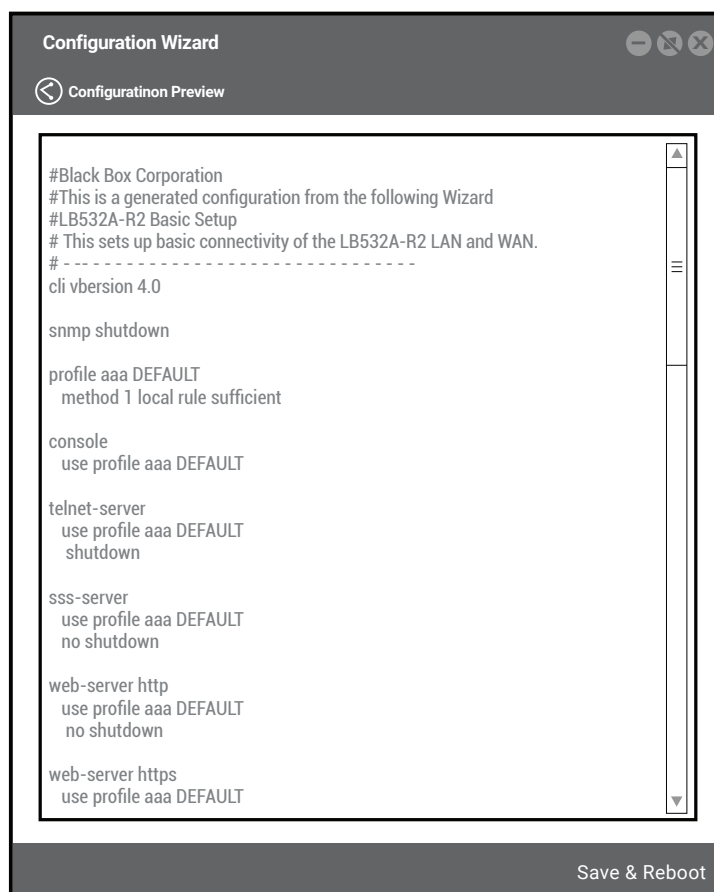

FIGURE 5-5. CONFIGURE PREVIEW OPTION

CHAPTER 5: WIZARD INTERFACE

When you choose the save and reboot option, a prompt will ask you to confirm. If the configuration is correct, select Yes as shown in Figure 5-6.

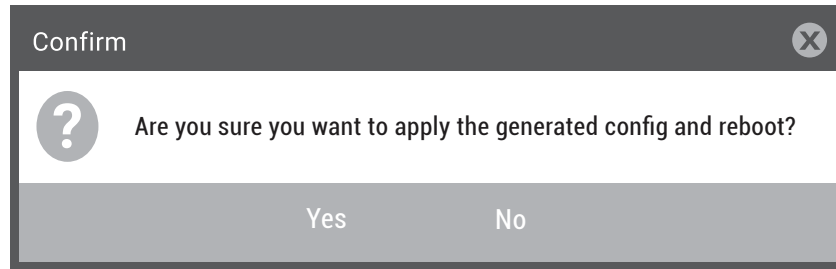

FIGURE 5-6. CONFIRMATION SCREEN

Typically the time to reboot and re-establish a DSL link so the extender can pass traffic will be less than 2 minutes.

CHAPTER 6: CLI OPERATION AND CONFIGURATION

You can connect a PC to configure the LB512A-KIT-R2, LB532A-R2 Ethernet Extender using the CLI.

6.1 CONNECT WITH SSH

1. Connect the Ethernet cable.
2. Connect the power supply.
3. Connect via SSH to the extender through its IP address:
 - Default remote IP address: 192.168.200.10
 - Default local IP address: 192.168.200.11
4. Login with the default username admin and no password.

6.2 CHANGE THE IP ADDRESS (DEFAULT: 192.168.200.10)

Follow the command sequence below.

```
node~>enable
node~#configure node~(cfg)#context ip router
node~(ctx-ip)[router]#interface LAN
node~(if-ip)[router.LAN]#no ipaddress 192.168.200.10/24
node~(if-ip)[router.LAN]#ipaddress <new address>/<new mask>
```

6.3 CHANGE THE DEFAULT USERNAME

The default username will be removed once a new one is created. Follow the command sequence below:

```
node~>enable
node~#configure
node~(cfg)#superuser <username> password <password>
```

6.4 SAVE THE CONFIGURATION

Follow the command sequence below:

```
node~>enable
node~#configure
node~(cfg)#copy running-config startup-config
```

6.5 COPPER LINK LINE COMMANDS

LOCAL AND REMOTE

This will set the extender as Local or Remote. Local is typically used at the network, Remote is typically used at the remote device or remote network. LB512A-KIT-R2 is already configured one as Local and one as Remote.

```
node(cfg)# mode {local|remote}
```



CHAPTER 6: CLI OPERATION AND CONFIGURATION

ANNEX TYPE

Consult Black Box Technical Support at 877-877-2269 or info@blackbox.com before changing this setting.

```
node(prt-dsl)[0/0]# annex-type { b-g | a-f }
```

LINE RATE CONFIGURATION

This will increase the line rate of the extender. Your extender defaults to auto-matically select the optimal rate based on the distance (adaptive).

```
node(prt-dsl)[0/0]# payload-rate {adaptive [max <192..15296>] | <192..15296>}
```

MODULATION SCHEME

NOTE: Higher TC-PAM rates will increase maximum payload rates available, but will decrease distance. Your extender defaults to automatically select the optimal setting. Consult the rate reach chart to determine your optimal setting if you choose to hard-set this value. Higher TC-PAM rates are ideal for shorter cable runs offering max symmetrical (upstream/downstream) speeds of 11.4 Mbps (TCPAM64) and 15.3 Mbps (TCPAM128) per pair.

```
node(prt-line)[0/0]# tcpam {auto(16/32) | auto(64/128) | 16 | 32 | 64 | 128}
```

COPPER LINK PORTS

The configurations below are used to configure various aspects of the copper link port(s).

```
node(cfg)# port dsl 0 0
```

SIGNAL TO NOISE RATIO

Configures the acceptable noise margin for adaptive rate. SNR is the relative strength of the DSL signal to Noise ratio. 6 dB is generally the lowest dB recommended in order for the modem to be able to synch. Generally speaking, as overall bandwidth increases, your signal to noise ratio decreases. The higher the number the better. Your extender defaults to 6, giving you the highest likelihood to connect.

```
node(prt-dsl)[0/0]# snr-margin <-10..22>
```

Below 6 dB	bad
6 dB–10 dB	fair
11dB–20 dB	good

DESCRIPTION

This is the description of the port/line (copper link connection). (Ex: "This line goes to building 4") When entering a description with spaces in the text, the description must be in quotations.

```
node~(prt-dsl)[0/0]# description <description>
```

SERVICE MODE

Configures the number of pairs (wires) you want to use. The LB512A-KIT-R2, LB532A-R2 will default to the maximum number of wires available on your version of the G.SHDSL.bis CPE: LB512A-KIT-R2, LB532A-R2 (4-wire).

```
node~(prt-dsl)[0/0]# service-mode { 2-wire | 4-wire }
```

CHAPTER 6: CLI OPERATION AND CONFIGURATION

SHUTDOWN

Disables or enables copper link port(s).

```
node~(prt-line)[0/0]# [no] shutdown
```

EXIT

Goes back to parent mode.

```
node~(prt-line)[0/0]# exit
```

SHOW

Displays all the configured options of the LB510A-R2 copper link port(s)

```
node(cfg)# show port line 0 0
```



APPENDIX A: REGULATORY INFORMATION

A.1 EMC

- ♦ FCC Part 15, Class A
- ♦ EN55022, Class A
- ♦ EN55024

A.2 SAFETY

- ♦ UL 60950-1/CSA C22.2 NO. 60950-1
- ♦ IEC/EN60950-1
- ♦ AS/NZS 60950-1

A.3 PSTN REGULATORY

- ♦ FCC Part 68
- ♦ CS-03
- ♦ AS/ACIF S043:2003

A.4 FCC PART 68 (ACTA) STATEMENT

This equipment complies with Part 68 of FCC rules and the requirements adopted by ACTA. On the bottom side of this equipment is a label that contains—among other information—a product identifier in the format US: AAAEQ##TXXXX. If requested, this number must be provided to the telephone company.

The method used to connect this equipment to the premises wiring and telephone network must comply with the applicable FCC Part 68 rules and requirements adopted by the ACTA.

If this equipment causes harm to the telephone network, the telephone company will notify you in advance that temporary discontinuance of service may be required. But if advance notice isn't practical, the telephone company will notify the customer as soon as possible. Also, you will be advised of your right to file a complaint with the FCC if you believe it is necessary.

The telephone company may make changes in its facilities, equipment, operations or procedures that could affect the operation of the equipment. If this happens the telephone company will provide advance notice in order for you to make necessary modifications to maintain uninterrupted service.

If trouble is experienced with this equipment, for repair or warranty information, please contact our company. If the equipment is causing harm to the telephone network, the telephone company may request that you disconnect the equipment until the problem is resolved.

Connection to party line service is subject to state tariffs. Contact the state public utility commission, public service commission or corporation commission for information.

APPENDIX A: REGULATORY INFORMATION

A.5 INDUSTRY CANADA NOTICE

This equipment meets the applicable Industry Canada Terminal Equipment Technical Specifications. This is confirmed by the registration number. The abbreviation, IC, before the registration number signifies that registration was performed based on a Declaration of Conformity indicating that Industry Canada technical specifications were met. It does not imply that Industry Canada approved the equipment.

This Declaration of Conformity means that the equipment meets certain telecommunications network protective, operational and safety requirements. The Department does not guarantee the equipment will operate to the user's satisfaction. Before installing this equipment, users should ensure that it is permissible to be connected to the facilities of the local telecommunications company. The equipment must also be installed using an acceptable method of connection. In some cases, the company's inside wiring associated with a single line individual service may be extended by means of a certified connector assembly (telephone extension cord). The customer should be aware that compliance with the above condition may not prevent degradation of service in some situations. Repairs to some certified equipment should be made by an authorized maintenance facility designated by the supplier. Any repairs or alterations made by the user to this equipment, or equipment malfunctions, may give the telecommunications company cause to request the user to disconnect the equipment. Users should ensure for their own protection that the ground connections of the power utility, telephone lines and internal metallic water pipe system, are connected together. This protection may be particularly important in rural areas.

A.6 RADIO AND TV INTERFERENCE (FCC PART 15)

This equipment generates and uses radio frequency energy, and if not installed and used properly—that is, in strict accordance with the manufacturer's instructions— may cause interference to radio and television reception. This equipment has been tested and found to comply with the limits for a Class A computing device in accordance with the specifications in Subpart B of Part 15 of FCC rules, which are designed to provide reasonable protection from such interference in a commercial installation. However, there is no guarantee that interference will not occur in a particular installation. If the equipment causes interference to radio or television reception, which can be determined by disconnecting the cables, try to correct the interference by one or more of the following measures: moving the computing equipment away from the receiver, re-orienting the receiving antenna, and/or plugging the receiving equipment into a different AC outlet (such that the computing equipment and receiver are on different branches).

A.7 EC DECLARATION OF CONFORMITY

We certify that the apparatus identified above conforms to the requirements of Council Directive 1999/5/EC on the approximation of the laws of the member states relating to Radio and Telecommunication Terminal Equipment and the mutual recognition of their conformity.

The safety advice in the documentation accompanying the products shall be obeyed. The conformity to the above directive is indicated by the CE sign on the device.

In accordance with the requirements of council directive 2002/96/ EC on Waste of Electrical and Electronic Equipment (WEEE), ensure that at end-of-life you separate this product from other waste and scrap and deliver to the WEEE collection system in your country for recycling.



APPENDIX B: DISCLAIMER/TRADEMARKS

B.1 DISCLAIMER

Black Box Corporation shall not be liable for damages of any kind, including, but not limited to, punitive, consequential or cost of cover damages, resulting from any errors in the product information or specifications set forth in this document and Black Box Corporation may revise this document at any time without notice.

B.2 TRADEMARKS USED IN THIS MANUAL

Black Box and the Black Box logo type and mark are registered trademarks of Black Box Corporation.

Any other trademarks mentioned in this manual are acknowledged to be the property of the trademark owners.



**NEED HELP?
LEAVE THE TECH TO US**

**LIVE 24/7
TECHNICAL
SUPPORT**

1.877.877.2269

