



# Cisco IP DECT Phone 6800 Series Deployment Guide



DECT (Digital Enhanced Cordless Telecommunications) is a standard for wireless, mobile voice services. Originally from Europe, DECT has been adopted worldwide.

This document contains information about the capabilities and hardware available in version 480 of the DECT firmware on Cisco.com.

## Revision History

Issue Date	Comments
12/09/2019	Initial Version
03/27/2020	Reformatted the guide with the template
5/1/2020	Added suggestions about cabling, power and preparing the base station locations.
5/24/2020	Updated range and density sections. Added information about secure call densities. Figure numbers updated.
8/20/2020	Added 6823 handset, DBS-110 Base Station, 110 Repeater information, and updates for Firmware 4.8.
10/18/2021	Updated support for Dual Cell system
9/22/2022	Updated Network considerations

# Contents

- INTENDED AUDIENCE ..... 5**
- QUICK SET UP AND INSTALLATION PROCESS ..... 6**
  - PLAN FOR THE DEVICE INSTALLATION ..... 6
  - UPGRADE THE DEVICES ..... 7
  - INSTALLING THE BASE STATION ..... 8
- INTRODUCTION..... 9**
  - REGULATORY AREAS COVERED WITH CISCO DECT SOLUTIONS ..... 9
  - SIGNAL AND BANDWIDTH ..... 10
  - REGISTRATION HIGHLIGHTS ..... 10
  - DEPLOYMENT ..... 10
  - SIGNAL AREA CHARACTERISTICS ..... 11
- PLAN YOUR DECT SYSTEM ..... 11**
- PLAN THE CAPACITY ..... 11**
  - DENSITY GUIDELINES..... 12
    - Audio Codec Considerations..... 13*
- MATCH THE BASE STATIONS TO THE DENSITY REQUIREMENTS ..... 13**
  - SINGLE CELL DEPLOYMENTS ..... 13
  - DUAL CELL DEPLOYMENTS ..... 14
  - MULTI-CELL DEPLOYMENTS ..... 14
- INSTALLATION ..... 15**
  - SINGLE CELL INSTALLATION ..... 18
    - Determine the Install Location for a Base Station ..... 18*
  - DUAL CELL AND MULTICELL INSTALLATION ..... 19
    - Scenario 1: Conference Room ..... 21*
    - Scenario 2: Multistorey Shops ..... 22*
    - Scenario 3: Mall Store or Small Shop ..... 22*
- NETWORK CONSIDERATIONS ..... 23**
- WORK WITH THE SITE LAYOUT AND SIGNAL BARRIERS ..... 23**
  - RADIO CONSIDERATIONS ..... 24
    - Building Penetration:..... 24*
    - Interference Sources:..... 24*
    - Radio/Cell Range:..... 24*
    - Attenuation ..... 25*
- READY TO ORDER EQUIPMENT ..... 25**
  - PRODUCT IDs..... 26
  - PROVISIONING APPROACHES ..... 28
- SITE SURVEY ..... 29**
  - Site Survey Tool ..... 29*
  - INSTALL THE BASE STATIONS ..... 32
    - Installation Caveats..... 32*
    - Troubleshooting ..... 33*
    - Rerun the Site Survey..... 33*

<i>Completion</i> .....	33
UPGRADE FROM OLD FIRMWARE .....	33
ABBREVIATIONS .....	33
<b>REFERENCES</b> .....	<b>34</b>

## **Intended Audience**

The target audience for this document include network administrators and anyone who plans, designs, and installs a Cisco IP DECT 6800 Series network.

## Quick Set up and Installation Process

This first section is a quick step-by-step guide. The details and context are found in the remainder of this document. You must read the entire document before you start your deployment to ensure success.

**Note:** The Cisco IP DECT 6800 Phone products support single cell, dual cell, and multicell deployments. All call control systems may not support multicell deployment. Currently, Cisco Webex Calling and Webex Calling Carrier support only single cell deployment. Before you begin, check with your call control provider to ensure that they support the deployment models described in this guide.

**Note:** There are many ways to install the base stations. This guide provides the best practices and the recommended deployment models supported by Cisco TAC.

### Plan for the Device Installation

These instructions are for the planner:

1. Review the site to install the DECT system.
  - Plan the location of the base stations.
    - Each base station covers 50m (164 feet) indoors. The base stations should be installed within 50 meters for good coverage. The location of the base station may be impacted by objects or barriers that create radio obstruction and interference. The handsets provide a free site survey tool to identify the impact of these potential barriers.
    - Each base station requires an Ethernet cable.
    - A power outlet is required for each base station if the Ethernet switch does not provide Power over Ethernet.
2. Determine the DECT equipment required:
  - Available base stations and repeater:
    - Cisco IP DECT DBS-110 Single-Cell Base Station
    - Cisco IP DECT DBS-210 Multi-Cell Base Station
    - Cisco IP DECT RPT-110 Repeater
  - The base stations vary in their support for SIP registrations and concurrent calls. For more information, see *Matching the Base Stations to the Density Requirements*.
  - Each handset supports up to 2 SIP registrations.
  - Available handsets:
    - Cisco IP DECT Phone 6823 Handset
    - Cisco IP DECT Phone 6825 Handset
    - Cisco IP DECT Phone 6825 Ruggedized Handset

- A foot stand is provided to place the base station on a table or shelf.
  - An optional kit is also available, but sold separately, to mount the base stations on the wall or ceiling.
  - The part numbers of the products are listed in the section *Product IDs*
3. Order and receive the equipment.
  4. Ship the equipment to the installation site.

The equipment may be upgraded either at a staging site before reshipping or at the installation site after reshipping. For information about firmware upgrade, see *Upgrade the Devices*.

## Upgrade the Devices


These instructions may be completed at a staging site or at the installation site.

1. Unpack and register the base stations to the call system.
2. Upgrade the base stations to the desired firmware version, if necessary.
  - The base stations and handsets are shipped with a firmware version that may be used in production or upgraded to the latest firmware upgrade supported by the call control system.
  - Cisco's best practice recommendation is to use the most recent firmware load available on Cisco.com.
  - Each base station may take up to one hour to upgrade.
3. Select and set the desired configuration parameters. Follow the instructions in the *Cisco IP DECT 6800 Series Administration Guide* to configure the base stations.
4. Unpack the handsets and remove the battery which is inside the rear battery door of each handset. Remove the plastic shield from the battery and reinstall the battery.
  - There is only one way that the battery fits inside the handset: if it isn't sliding into its slot easily, turn the battery over and try again.
  - The battery comes partially charged and the handset should be left on its cradle to charge fully before using the handset.
  - You can register each handset with the base station before charging and then upgrade the firmware while they charge on the cradle.
5. Register the handsets to the base stations.
6. If the base station sends a more recent firmware load to the handset, the handset may require one hour to complete the upgrade.

**Caution:** The handset must be placed on the cradle until the upgrade is completed. Don't remove the handset during upgrade to avoid permanent damage of the handset.

## Installing the Base Station

You may reship the configured base stations to the installation sites or install in the same site you received the base stations.

1. Place the base stations around the site in high locations without securing them to the wall or ceiling. You can use step ladders to test the locations.
2. Use the site survey tool on a few handsets to check the base station location for good coverage. If there is more than one base station to install, you can run the site survey to check the coverage. For more information, see *Site Survey*.
3. To use the survey tool in the handset, press **Menu**  and **\*47\***. The IP Search screen appears.
4. Press the **Select** softkey when the MAC address of the base station appears.
  - If you are using more than one base station, repeaters, or a combination of base stations and repeaters, you can select each of them from the same handset and test the radio strength to the handset. Unlike during a call, the handset doesn't roam between base stations when you're using the site survey tool. However, you can manually switch between base stations and repeaters during the site survey test by returning to the base station and repeater selection page **IP Search**.
5. Make a few test calls from the handsets.
6. Mount the base stations with the included foot stands, or the kits for wall or ceiling mount which are sold separately.
7. Place the handsets with their cradles at each user location, or in a central location if they are shared.



## Introduction

The Cisco IP DECT Phones 6800 Series is the mobility solution within Cisco's Multiplatform Phone portfolio. One advantage of Cisco's DECT solution over Wi-Fi is that the DECT solution components, the phones and the base stations have the same architecture and are designed to work exclusively with each other.

Unlike Wi-Fi, a customer can't use a third party DECT base station to support their Cisco handset. Third party base stations, repeaters, and handsets are not supported with the Cisco DECT Phone solution. The product design ensures that the DECT base station and the handset run on compatible frequencies.

You don't need to be an expert in DECT or wireless products to successfully install a working system. You must read the entire document to ensure successful deployment.

This document:

- Describes the elements in planning and designing a Cisco IP DECT 6800 Series Phone system.
- Provides a simplified design procedure.
- Includes the network planning and deployment processes used in North America and Europe.

The Cisco IP DECT 6800 Series contains:

- Cisco IP DECT Phone DBS-110 Single-Cell Base Station
- Cisco IP DECT Phone DBS-210 Multi-Cell Base Station
- Cisco IP DECT Phone RPT-110 Repeater
- Cisco IP DECT Phone 6823 Handset
- Cisco IP DECT Phone 6825 Handset
- Cisco IP DECT Phone 6825 Ruggedized Handset

Note: The 6825 Ruggedized Handset operates identically to the 6825 handset, but the Ruggedized Handset is IP65 rated for dusty and damp environments.

## Regulatory Areas Covered with Cisco DECT Solutions

This information is only for reference. Cisco's ordering process allows you to receive only the units which are set up correctly for your region. These are the current areas covered with Cisco DECT solutions:

- 1880-1900 MHz (Australia and New Zealand – power  $\leq$  158 mW)
- 1880-1900 MHz (E.U. and APAC)
- 1920-1930 MHz (U.S. and Canada)

Note: For Mexico, Cisco offers the NA (North America) version with NOM compliance.

There are other requirements for DECT in other regions of the world. When Cisco expands the offer, the other regions not in the above list will be offered.

## Signal and Bandwidth

The Cisco IP DECT Phone 6800 Series is built on Digital Enhanced Cordless Telecommunications (DECT) technology. The technology was developed for many users working in close proximity. DECT uses a low bit rate that provides good voice quality at 32kbps per channel, and effective for mobile phone users at home and small to medium sized industrial sites.

This series uses the Session Initiation Protocol (SIP) to provide a Voice over IP (VoIP) solution over Ethernet. The DECT base station connects to the call server and provisioning servers over Ethernet, and then uses DECT technology to connect, register, and provision the handsets.

DECT works close to the 1.9 GHz frequency band to avoid interference with Bluetooth, Wi-Fi, and microwave frequencies. The frequencies used by DECT are in the unlicensed residential spectrum and DECT devices may exhibit interference when they are in a close range of commonly used residential and commercial appliances. The actual DECT frequency used in your region is regulated by your country and may be different in other regions of the world.

Like other radio technologies, DECT uses a combination of Frequency Division Multiplexing (channels) and Time Division Multiplexing (time slots) techniques. DECT devices share available channels on the radio spectrum and limit the active number of devices within a close range.

For more information about device density, see *Density Guidelines*.

## Registration Highlights

The base stations register with the call control system and upgrade the firmware immediately after registration, if the system is configured. If more recent firmware load isn't available to download, they will register and use the default firmware shipped with the base station. Cisco recommends that customers and partners always run the latest available firmware. If you connect to Cisco Webex Calling or Webex Calling Carrier, the firmware versions are automatically maintained and updated. When the base stations have registered with the call control system, the handsets register with the base stations and then receive the firmware upgrades from the base stations. For call control registration, the call control system requires the base station's MAC address.

## Deployment

You can collect the network requirements for capacity, coverage, and quality to start the network deployment. Consider the location of the base stations where the handsets are used. Ensure that there aren't signal blocking obstacles near the base station.

The handsets have a simple site survey tool that you can use to determine the best base station locations for maximum coverage. For more information, see *Site Survey*. Mount the base stations in a high location with a clear line of sight to the area where the handsets are used. If you mount

the base stations behind closed doors or between steel beams, it creates signal interference which leads to reduced range and a reduced coverage area. Use the site survey tool to ensure good coverage where the handsets are used.

If the service area has many rooms and obstacles for good DECT signaling, you may need a multi-cell deployment. If the building is wood framed with drywall, you may not experience poor signal strength.

## **Signal Area Characteristics**

The signal area produced by the base station is omnidirectional and resembles a sphere. If you mount the base station very close to the ground or in a corner, the location can reduce the optimal signal strength. The best mounting area is a location high up on the wall, on the wall, or ceiling away from any corners. There are scenarios in buildings made of less obstructive materials such as wood and drywall, where the corner mounted base station serves more than one room. If the floors are like that of a house rather than a heavy, industrial building, a ceiling mounted base station can provide service to the floor above. Use the site survey to ensure that you have good coverage.

## **Plan Your DECT System**

Good system planning is essential to achieve the expectations of the customer. Typically, the network requirements include (but not limited to):

- The area to be covered.
- The type or architecture of the building and/or topology, and so on. This includes the material and thickness of the walls.
  - You don't require precise knowledge about the makeup and thickness of the walls. You should be aware of the "interior grade" and "exterior grade" walls. The site survey tool helps to determine if the walls are compromising good signal strength between different areas of your installation.
- The estimated traffic in each coverage area.
- Any signaling obstacles located in each coverage area.
- Any new Ethernet cables or power outlets required to support the base station mounting locations.

## **Plan the Capacity**

Capacity for each installation includes the number of simultaneous users and projected number of simultaneous calls. Each handset uses DECT channels on the base station. If you have more handset line registrations on a base station than its concurrent call capacity, every line cannot support calls at the same time. You must plan your capacity.

Capacity planning requires the following knowledge for each site:

- Intended number of handsets simultaneously registered

- Intended traffic load
- Intended coverage area

The DBS-110, DBS-210 base stations, and RPT-110 repeater signal strength:

- Indoor: 20-50 meters (60-164 feet) radius
  - The range of this radius depends on the nature and quantity of any radio signal impeding items or material in the installation site. Some of these may include items made of metal: shelving, doors, and supporting beams.
  - One base station will be sufficient for a single retail store's area if there are no thick walls or other sources of interference.
  - Adding base stations and repeaters help you to work around signal barriers.
- Outdoor: 300 meters (984 feet) radius
  - Note: The base stations and repeaters are not weather-guarded for extreme heat, damp, or cold conditions. If they should be used outdoors, they must be installed inside a weather-proof enclosure that does not severely impact their signal strength.

## Density Guidelines

In high density areas that require maximum channels, the base stations located very closely can cause interference. To minimize base station interference and good audio experience, follow these recommendations:

- Install base stations at least 2 meters (6.5 feet) away from each other.
- In the 20 MHz frequency spectrum (EU spectrum), the density should be 7 or fewer base stations in 100 square meters (1,076 square feet).
- In the 10 MHz frequency spectrum (Americas spectrum), the density should be 4 or fewer base stations in 100 square meters (1,076 square feet).

Use these conditions with the density and possible interference:

- **Low Density, Low Interference:** A Cisco IP DECT Base Station provides a coverage of 50 meters (164 feet) radius in a straight line without radio interference. This means, if the density is less than 5 simultaneous calls and not more than 30 simultaneous registrations, you only need one Cisco IP DECT Base Station.
- **Low Density, High Interference:** A Cisco IP DECT Base Station can support up to 30 line registrations, with up to 10 narrowband calls or 5 wideband calls. For more information, see *Single Cell Deployments*.  
For the DBS-210, if you add another base station, you can register 60 handsets, and support 16 narrowband or 8 wideband calls at one time. If high interference is expected because of RF attenuation or RF interferences, you can add more base stations or repeaters.  
For the DBS-110, if you add another base station, system can support up to 20 narrowband calls or 10 wideband calls. You can add up to 6 repeaters to extend the area covered.
- **High Density, Less Interference:** A Cisco IP DECT Base Station provides coverage of 20-50 meters (60–164 feet) radius indoors depending on the interference and attenuation. It

provides 300 meters (984 feet) radius coverage in plain outdoors. The 300 meters (984 foot) radius coverage area is also good for a room that is 300 meters (984 feet) in radius without any interference and attenuations.

- **High Density, High Interference:** You need the DBS-210 Multi-Cell Base Stations with many base stations deployed in the same system to achieve the required capacity. In high density areas where you need maximum channels, base stations located close together can cause interference. To minimize base station interference, work with these audio codec considerations for a good audio experience.

### Audio Codec Considerations

You should consider the audio codecs to use when you plan the capacity.

- The Cisco IP DECT 6823 and 6825 handsets support G722 for wideband and G726 for narrow band.
- The Cisco IP DECT DBS-110 and DBS-210 Base Stations support G.711 a-law &  $\mu$ -law, G.722.2, G.726, and G.729a/ab
- The DECT protocol supports only two codecs. The administrator must choose the two supported protocols to use. Choose one wideband and one narrowband codec.
- The base station does the required transcoding based on the negotiated codec for each call.
- The wideband codec occupies 2 channels and the narrowband codec occupies 1 channel.
- If you expect more simultaneous calls, use the narrowband codec to increase the available number of channels. If you configure the wideband codec, you may add more base stations to increase the channel capacity.

## Match the Base Stations to the Density Requirements

When you know how big your system will be in terms of the number of users who require handsets, the area to be covered and the concurrent calls the system must support, you can check the capacity of the base stations for each type of deployment.

### Single Cell Deployments

The following table provides the handsets supported and concurrent calls for a single cell DECT system.

User Requirements	DBS-110	DBS-210
Number of SIP Registrations	30	30
Concurrent Narrowband Calls	10	10
Concurrent Secure Narrowband Calls	10	8
Concurrent Secure Wideband Calls	5	5
Maximum Repeaters that may be connected to the system	6	3

The single cell system is mostly used in small businesses and home offices. The DBS-110 is the most cost-effective choice for a single cell system that is not expected to grow in number of handsets. The DBS-210 is an ideal choice for a single cell system if you want to add more base stations to the system in the future. If you are starting with the DBS-110 and you need to expand your handset quantity, you must replace the DBS-110 with a DBS-210 and add more DBS-210s to the system. If you are starting with a DBS-210, you may continue using the original DBS-210 and add more DBS-210s to increase your handset quantity and call capacity.

If you want to add more base stations and there are radio signal blockers, such as steel doors, there must be a clear line of sight between the base stations.

## Dual Cell Deployments

Dual cell system contains up to 2 base stations with radio signal overlap for seamless handover. Cisco recommends using LAN synchronization for base stations to sync.

The following table explains the support for handsets and concurrent calls for a Dual Cell system.

User Requirements	DBS-110	DBS-210
Number of SIP Registrations	30	60
Concurrent Narrowband Calls	20	16
Concurrent Secure Narrowband Calls	20	16
Concurrent Secure Wideband Calls	10	10
Maximum Repeaters that may be connected to the system	12	6
DECT Synchronization	LAN (recommended) or Air	

The DBS-210 would be an ideal choice if you want the flexibility to increase to more than two base stations. The DBS-110 based dual cell system would be ideal and cost-effective if the number of handsets aren't increasing above 30 and the number of concurrent calls requirement is within 20. Note that, if you have a system with DBS-110 and if you want to increase to three or more base stations, then you must replace the DBS-110s with DBS-210. One DECT network can only contain either DBS-110 or DBS-210.

## Multi-Cell Deployments

Multi-cell systems can have 3 to 1000 base stations where the radio signals overlap for seamless handover. For a Multi-cell system, Cisco recommends LAN synchronization, while Air synchronization is possible but not recommended.

The following table explains the support for handsets and concurrent calls for a system built only on DBS-210 base stations.

User Requirements	DBS-210
Number of SIP Registrations with 250 base stations deployed	1000
Concurrent Narrowband Calls: 250 base stations	2032
Concurrent Secure Narrowband Calls: 250 base stations	2032
Concurrent Secure Wideband Calls: 250 base stations	1016
Maximum Repeaters that may be connected to the system	100
DECT Synchronization	LAN (recommended) or Air

The Multi-cell system is mostly used in medium business that have large coverage areas with many users. The DBS-210 is the only option for the multi-cell system.

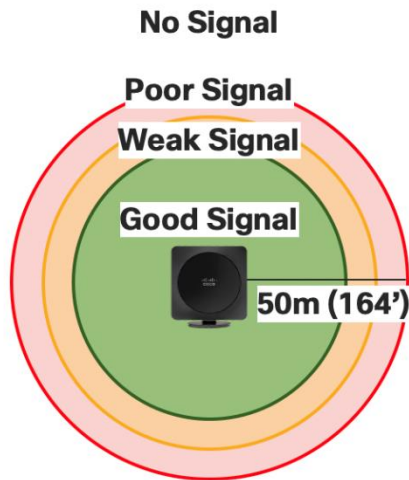
## Installation

Capacity planning helps to identify if a single cell or multi-cell system is required. Cisco recommends a single cell set up for small area with low density. Otherwise, you can set up a multi-cell system.

Typically, a small retail store can have a single cell system. You must confirm this with a site survey. If the store is an open area without real radio signal barriers, one base station can cover the entire store.

The range of a base station is 50 meters (164 feet) radius indoors in a building made of standard brick and mortar construction with basic inference from low level shelving and other items found in a retail store or workplace. When you move away from the base station, the signal degrades from good, weak, poor, and to no signal.

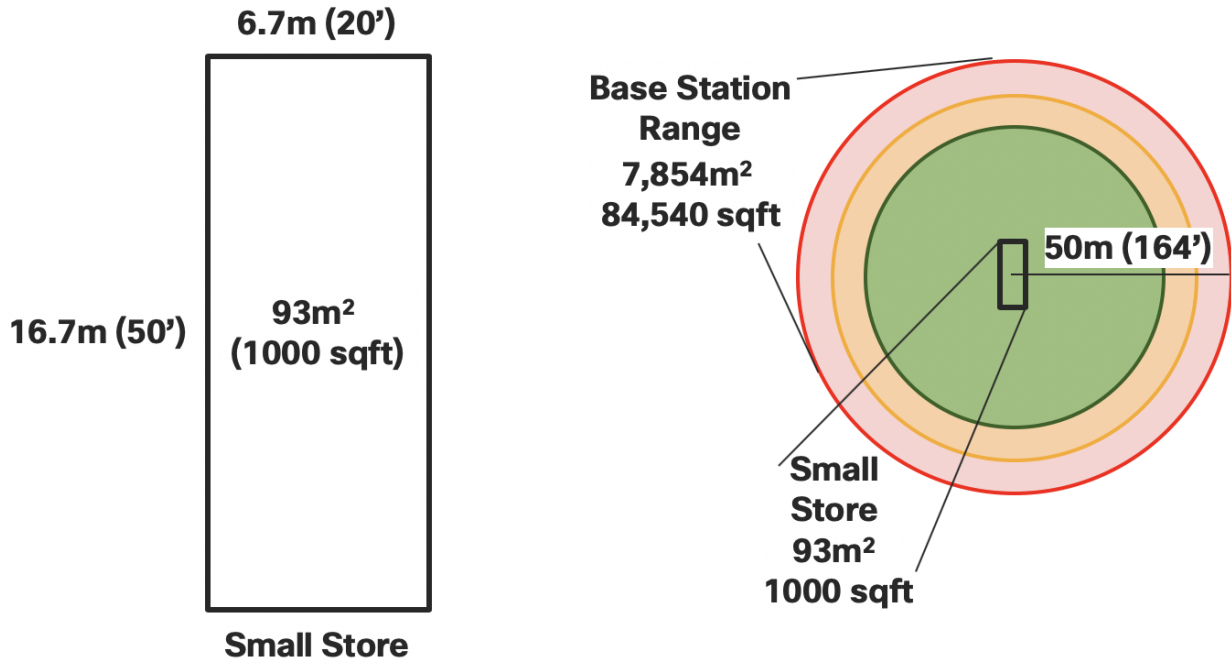
Figure 1: Base Station Signal Range



A 50 meter (164 feet) radius covers 7,854 square meters or 84,540 square feet. A typical small store in a mall or town center is 6 meters (20 feet) by 16.7 meters (50 feet) which is 93 square meters or 1000 square feet. That is a small fraction of the base station's range if there are no serious signal barriers near the base station.

Figure 2 shows the range of a single base station compared to the size of a small retail store.

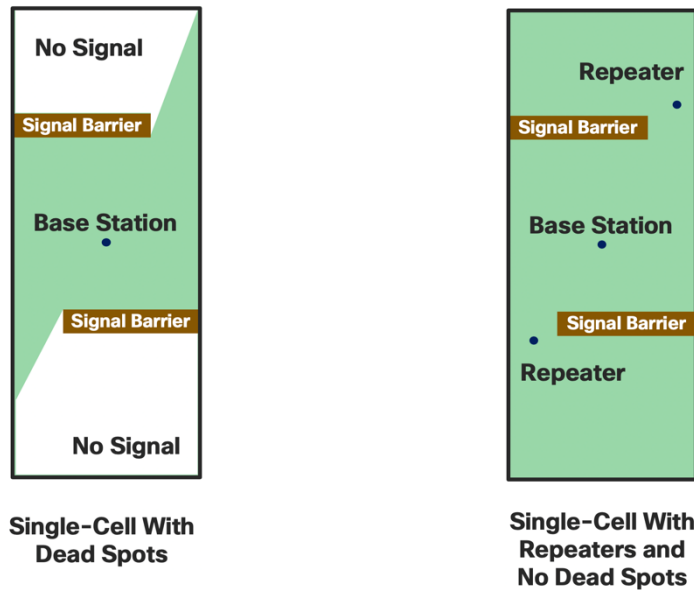
Figure 2: Base Station Range with Few Signal Barriers Compared to the Size of a Small Store



If there are signal barriers in the store, such as a steel wall, shelving unit, or other radio emitting devices, you need one or more base stations to cover the entire site as shown in Figure 3.

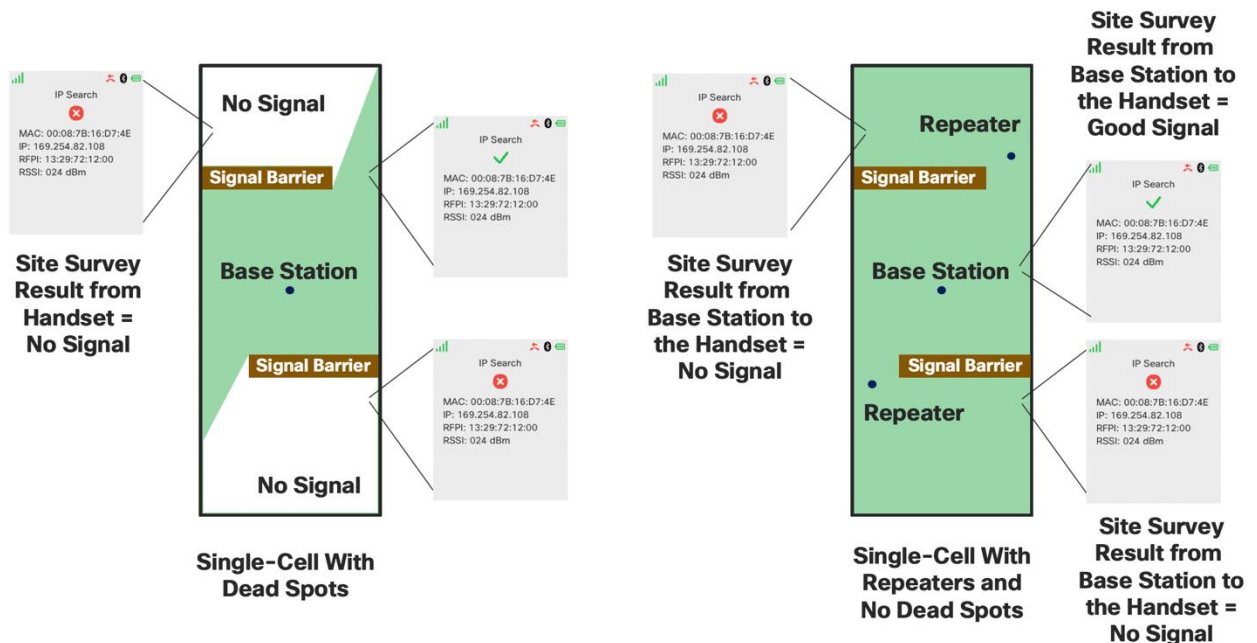


Figure 3: A Small Store Installation with Signal Barriers



If there are dead spots that require a good signal, you may need to add another base station. Identify the number of base stations you need, place the base stations in temporary locations, such as, on top of step ladders, and run the site survey tool on a handset as shown in *Figure 4*. For more information on instructions to use the tool, see *Site Survey Tool*.

Figure 4: Check the Signal with the Site Survey Tool





## Single Cell Installation

This section guides you with the physical placement of the base station in a single cell system.

### Determine the Install Location for a Base Station

To optimize the time in the installation process, mount the base station using these recommendations:

- **Small to medium size area:** For a store in a shopping mall, the base station must be installed in the middle of the space below the false ceiling.
- **Two-floor building:** Mount the base station at the center of the first floor false ceiling. You can verify coverage with the site survey tool, as a few buildings may have ceilings out of materials that do not allow the radio signal to the upper floor.
- **Large hall:** These are typically large retail stores with more than 4,500 square meters (50,000 square feet). The base station should be installed in the middle of the space below the false ceiling. If the signal strength is poor in some areas, you may need to install more base stations.

Follow these steps to improve the install location:

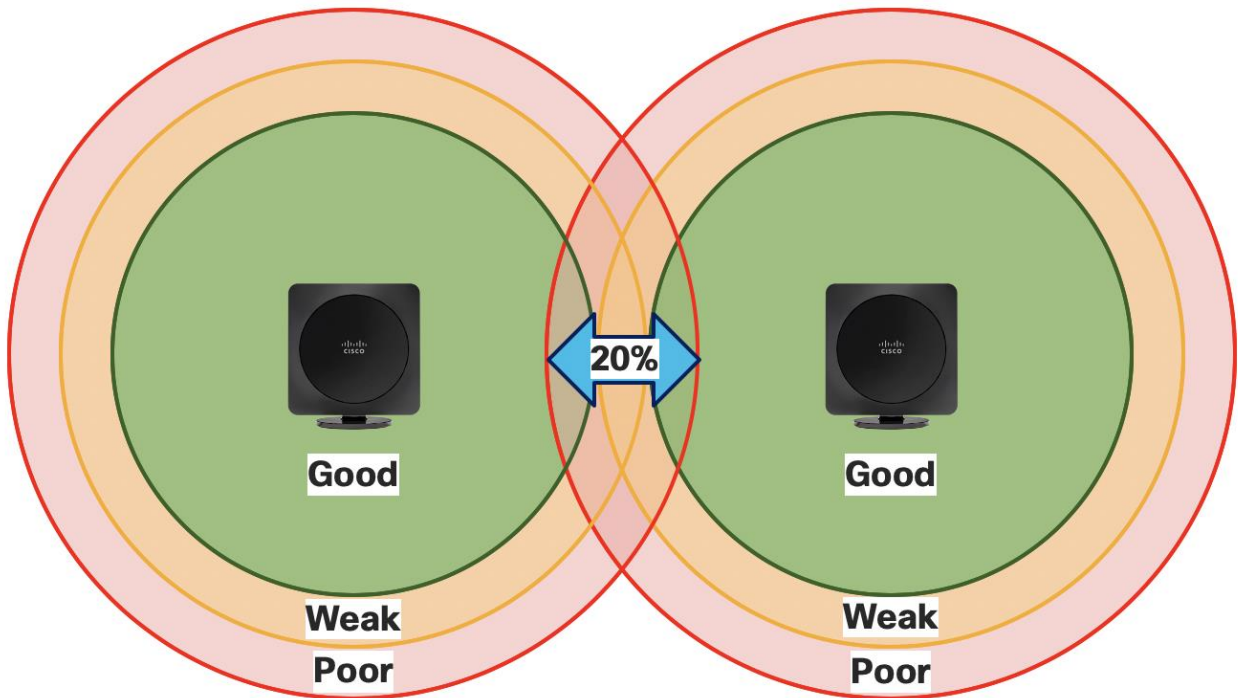
1. Place the base station in the center with a line of sight to the coverage area.
2. Run the site survey tool.
3. Move around the entire coverage area and locate any dead spots. If there are dead spots, move the base station towards the dead spot and repeat the site survey until you get the coverage you need. If all the dead spots can't be covered by repositioning the base station, add a second base station in multi-cell mode or add another base station. For more information, see *Multi-cell Installation*.

4. When you have found the optimum location for the base station, mount it permanently.

### Dual Cell and Multicell Installation

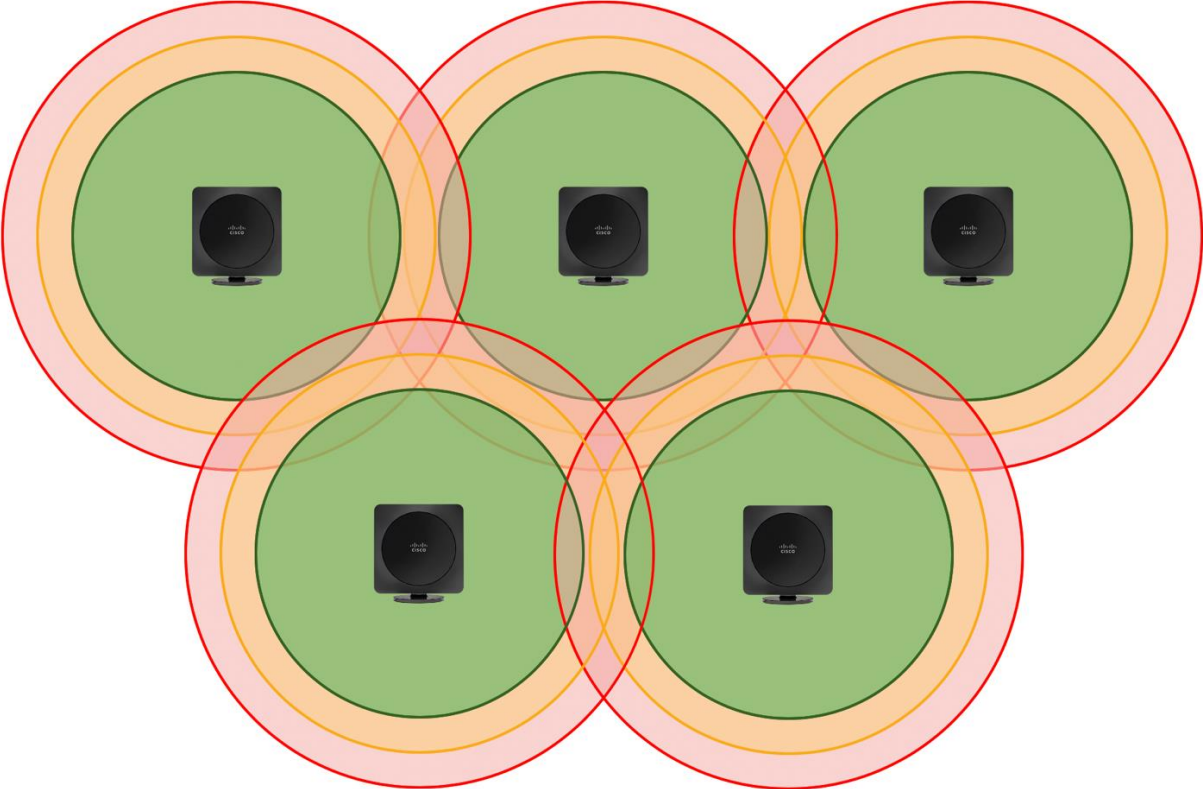
Coverage for a multicell system should provide an overlap of at least 20% to ensure that a handset can roam freely from one base station to another without any loss of coverage.

Figure 5: Cell Overlap



Cisco recommends that you place the base stations as shown in *Figure 6* to maximize the coverage. The overlap doesn't have to be exact. The placement depends on the RF attenuation in the deployment site. Based on the environment, you may have to place the base stations close to each other. In this figure, it is assumed that there is no RF loss due to the environment.

Figure 6: Multicell Installation



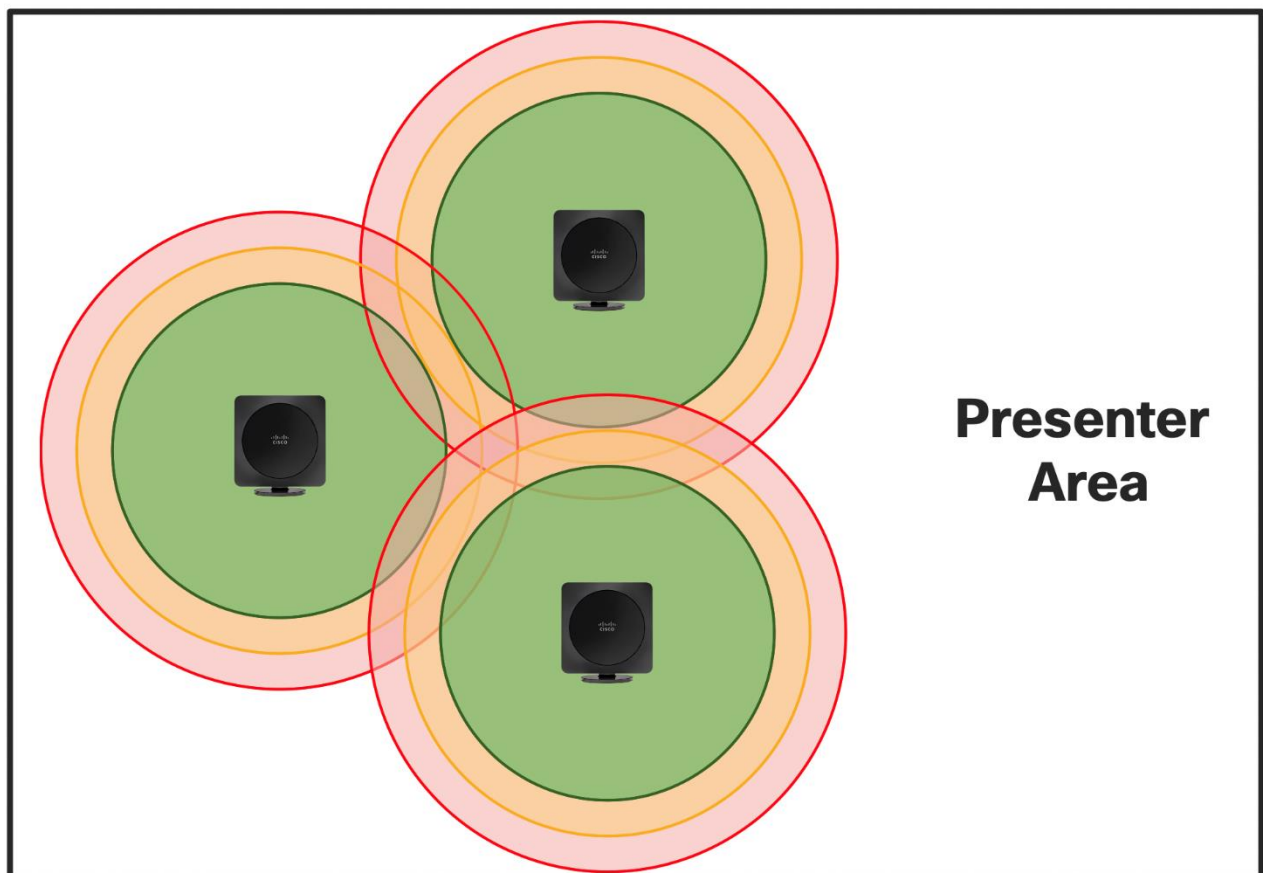
The following sections provides the example scenarios of the density considerations during the capacity planning.

### Scenario 1: Conference Room

- You have a conference room that can have 50 people. Each person has a handset and you expect to have a maximum of 20 simultaneous calls. You will need:
  - 5 base stations if the calls use wideband
  - 3 base stations if the calls use narrowband
- Install the base station in the ceiling.

If number of users is less than 30, then Dual cell deployment may be enough for this scenario.

Figure 7: Conference Room Setup

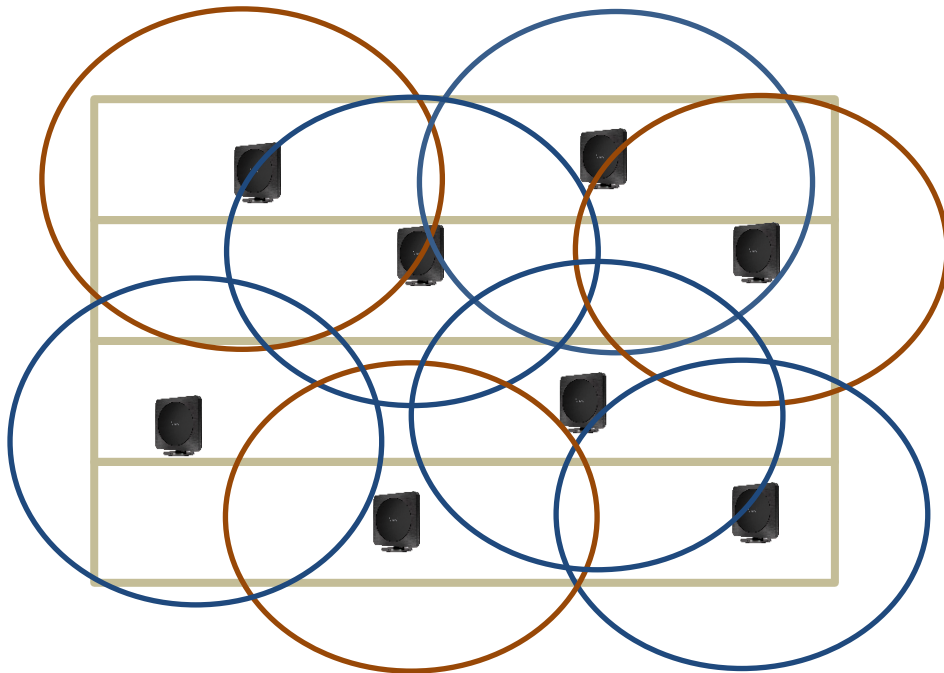


### Scenario 2: Multistorey Shops

For a medium-sized, two-floor shop with about 10 employees and about 5 simultaneous calls, the capacity table suggests only one base station. However, for a two-floor building, one base station isn't enough because of RF attenuation. Cisco recommends at least one base station for each floor. If there is an elevator to move between floors and the handset should have coverage while riding the elevator, you may need one or more base stations near the elevator to provide better coverage.

Install the base station in the ceiling or false ceiling on each floor.

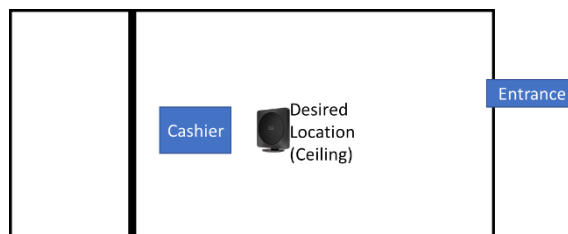
Figure 8: Multi-story Set up



### Scenario 3: Mall Store or Small Shop

For a typical mall store or small shop, one base station is enough. This base station should be installed in the center of the store for good coverage.

Figure 9: Small Shop



If the store has a metal door between the service side and the main area, select one of these options for good coverage:

- Add one more base station if Dual cell capacity is sufficient
- Add two or more base stations for larger systems
- Install the base station close to the metal door.

Install the base station at least 2 meters (6.5 feet) above the floor, in the center of the building.

The scenarios are only for illustrative purposes. Cisco recommends that you use the site survey tool to identify any dead spots in the coverage.

## Network Considerations

- Switch ports must be opened for the base station to connect and get an IP address.
- If you plan to use a Voice VLAN, ensure that the Voice VLAN is configured for the correct switch ports.
- If you plan to use PoE for the base stations, ensure that the switch is configured and there is enough power to allocate IEEE Class 2 POE for the base station.
- The IP address allocation for the base station can be done with DHCP or a Static IP address
- The firewall must open (S)NTP, DNS, HTTP(S), SIP(S) and (S)RTP ports (as appropriate) for the device to work properly
- Multicell can utilize multicast or peer-to-peer unicast for data synchronization. However, the primary base station within a peer-to-peer unicast configuration has no redundancy
- Base Stations using multicast within the same Multicell system must share the same layer 2 broadcast domain and be provisioned within the same layer 3 subnet
- Multicell multicast uses the IP address 224.x.x.x for data synchronization.
- Multicell multicast across a routed layer 3 multicast network is not currently supported.
- Multicell multicast requires that IGMP snooping be disabled on Meraki switches.
- Multicell unicast or multicast using IPv6 is not currently supported
- If LDAP is used for directories, ensure to open the LDAP ports.
- 

If DHCP options are used to point to the provisioning server, they must be configured.

You must open the HTTP(S) port for connections initiated by the base station. This is required for Firmware upgrades, provisioning, and to push the logs.

## Work with the Site Layout and Signal Barriers

DECT is resilient to interference from wireless frequencies commonly used for cell phones, Wi-Fi radios, and Bluetooth headsets. If there is an interference, the DECT protocol adapts the channel to minimize the impact. To ensure optimum use of the handsets and good coverage, perform a site survey and mount the base station in a strategic location. Consider the effects of coverage by RF attenuation and RF interference during planning to have a good coverage for the handset.

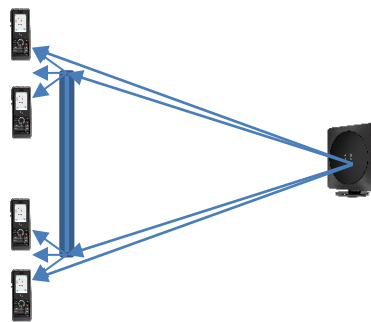
## Radio Considerations

Before planning the installation, the site survey should identify possible radio frequency attenuation objects in the coverage area. This section provides a few common attenuation and interference objects in a typical installation site.

### Building Penetration:

When a signal strikes a wall, it is diffracted or absorbed. This may reduce or distort the signal. The amount of absorption is dependent on the building type and its environment, and the amount of solid structure which includes concrete, metal frames, metallic doors, thickness, and so on. This is an important consideration when you plan the coverage.

Figure 10: RF Diffraction and Multiple Path



### Interference Sources:

The interference from other signals or the same network can make the receiving signals weak. DECT can handle some network interference and it uses different channels, if available. For interference from other signals, identify and plan the location of the base station. These are the sources of interference in a typical site :

- Other DECT systems
- Some strong cellular base stations

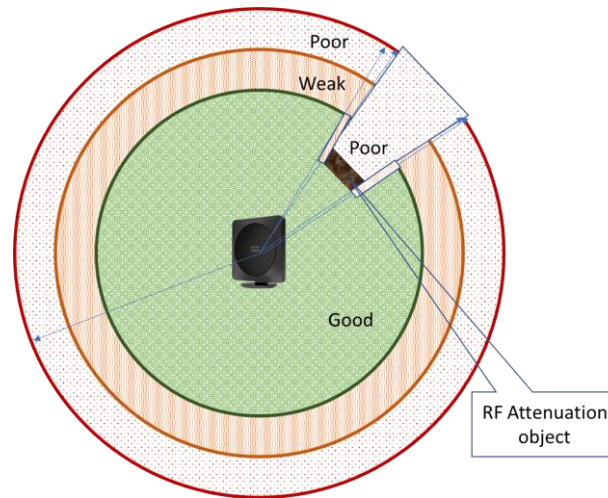
**Note:** DECT is not affected by Bluetooth, Wi-Fi, and most wireless cellular networks. The DECT frequencies are different from the frequencies used in these technologies.

### Radio/Cell Range:

The ideal situation is to always have the base station and handset in the line of sight. Line of sight means the straight physical path between the base station and the handset. Any interference or RF attenuation materials in the line of sight reduces the coverage distance. Each RF attenuation material has unique attenuation characteristic. The following figure explains the effect of RF attenuation material on the coverage area.



Figure 11: RF Attenuation Effect on Coverage



### Attenuation

The table in this section provides the attenuation levels for each material. The thickness of the material also plays a significant role in the attenuation. If the material is thicker, the attenuation is higher.

- If the wood material is thick, the attenuation level may change from low to medium.
- If the glass door is very thick, the attenuation level may change from medium to high.
- If there are tiles on both sides of the walls, attenuation is almost doubled through the wall

Material	Level of Attenuation	Comments
Wood	Low	Doors, floors, and so on
Plastics	Low	Room partitions
Tinted Glass	Medium	Wall hangings, glass door, and window
Living Objects	Medium	Crowds, and Plants
Bricks	Medium	Walls
Ceramic	High	Tiles
Concrete	High	Walls, pillars, floors, and stairs
Metal	Very High	Elevator, and cabinet

Cisco recommends that you identify the medium and high attenuation materials in your coverage plan.

### Ready to Order Equipment

At this point, you should know your deployment area, the number of base stations and handsets, and the type of handsets.

## Product IDs

These are the product IDs available in the Cisco IP DECT Phone 6800 Series.

Part number	Product description
CP-6823-3PC-BUN-NA	Cisco IP DECT Phone Bundle, Cisco IP DECT 6823 Handset and Multi-Cell Base Station, North America Power Adapter
CP-6823-3PC-BUN-UK	Cisco IP DECT Phone Bundle, Cisco IP DECT 6823 Handset and Multi-Cell Base Station, United Kingdom Power Adapter
CP-6823-3PC-BUN-CE	Cisco IP DECT Phone Bundle, Cisco IP DECT 6823 Handset and Multi-Cell Base Station, Continental Europe Power Adapter
CP-6823-3PC-BUN-AU	Cisco IP DECT Phone Bundle, Cisco IP DECT 6823 Handset and Multi-Cell Base Station, Australia Power Adapter
CP-6823-3PC-K9=	Cisco IP DECT 6823, Standard Handset, Battery, Cradle, Multiplatform Phone Firmware, No Power Adapter
CP-6823-3PC-NA-K9=	Cisco IP DECT 6823, Standard Handset, Battery, Cradle, Multiplatform Phone Firmware, North America Power Adapter
CP-6823-3PC-CE-K9=	Cisco IP DECT 6823, Standard Handset, Battery, Cradle, Multiplatform Phone Firmware, Continental Europe Power Adapter
CP-6823-3PC-AU-K9=	Cisco IP DECT 6823, Standard Handset, Battery, Cradle, Multiplatform Phone Firmware, Australia Power Adapter
CP-6823-3PC-UK-K9=	Cisco IP DECT 6823, Standard Handset, Battery, Cradle, Multiplatform Phone Firmware, United Kingdom Power Adapter
CP-6825-3PC-BUN-NA	Cisco IP DECT Phone Bundle, Cisco IP DECT 6825 Handset and Multi-Cell Base Station, North America Power Adapter
CP-6825-3PC-BUN-UK	Cisco IP DECT Phone Bundle, Cisco IP DECT 6825 Handset and Multi-Cell Base Station, United Kingdom Power Adapter
CP-6825-3PC-BUN-CE	Cisco IP DECT Phone Bundle, Cisco IP DECT 6825 Handset and Multi-Cell Base Station, Continental Europe Power Adapter
CP-6825-3PC-BUN-AU	Cisco IP DECT Phone Bundle, Cisco IP DECT 6825 Handset and Multi-Cell Base Station, Australia Power Adapter
CP-6825-3PC-K9=	Cisco IP DECT 6825, Standard Handset, Battery, Cradle, Multiplatform Phone Firmware, No Power Adapter
CP-6825-3PC-NA-K9=	Cisco IP DECT 6825, Standard Handset, Battery, Cradle, Multiplatform Phone Firmware, North America Power Adapter
CP-6825-3PC-CE-K9=	Cisco IP DECT 6825, Standard Handset, Battery, Cradle, Multiplatform Phone Firmware, Continental Europe Power Adapter
CP-6825-3PC-AU-K9=	Cisco IP DECT 6825, Standard Handset, Battery, Cradle, Multiplatform Phone Firmware, Australia Power Adapter
CP-6825-3PC-UK-K9=	Cisco IP DECT 6825, Standard Handset, Battery, Cradle, Multiplatform Phone Firmware, United Kingdom Power Adapter
CP-6825-RGD-K9=	Cisco IP DECT 6825, Standard Handset, Battery, Cradle, Multiplatform Phone Firmware, No Power Adapter, Ruggedized

Part number	Product description
CP-6825-RGD-NA-K9=	Cisco IP DECT 6825, Standard Handset, Battery, Cradle, Multiplatform Phone Firmware, North America Power Adapter, Ruggedized
CP-6825-RGD-CE-K9=	Cisco IP DECT 6825, Standard Handset, Battery, Cradle, Multiplatform Phone Firmware, Continental Europe Power Adapter, Ruggedized
CP-6825-RGD-AU-K9=	Cisco IP DECT 6825, Standard Handset, Battery, Cradle, Multiplatform Phone Firmware, Australia Power Adapter, Ruggedized
CP-6825-RGD-UK-K9=	Cisco IP DECT 6825, Standard Handset, Battery, Cradle, Multiplatform Phone Firmware, United Kingdom Power Adapter, Ruggedized
CP-6825-BAT=	Cisco IP DECT 6825, Li-Ion Battery
CP-6825-HC=	Cisco IP DECT 6825, Handset Cradle
CP-6823-PWR-NA=	Cisco IP DECT 6823, Power adapter for North America
CP-6823-PWR-CE=	Cisco IP DECT 6823, Power adapter for Europe Union
CP-6823-PWR-AU=	Cisco IP DECT 6823, Power adapter for Australia and New Zealand
CP-6823-PWR-UK=	Cisco IP DECT 6823, Power adapter for United Kingdom
CP-682X-PWR-NA=	Cisco IP DECT 6825, Power adapter for North America
CP-682X-PWR-CE=	Cisco IP DECT 6825, Power adapter for Europe Union
CP-682X-PWR-AU=	Cisco IP DECT 6825, Power adapter for Australia and New Zealand
CP-682X-PWR-UK=	Cisco IP DECT 6825, Power adapter for United Kingdom
CP-682x-WMK=	Wall mount kit for Cisco IP Phone 6800 Series Base Stations and Repeater
DBS-110-3PC-NA-K9=	Cisco IP DECT Base Station 110 Series, MPP, U.S. and Canada, 1920 - 1930 MHz, North America Power Adapter
DBS-110-3PC-CE-K9=	Cisco IP DECT Base Station 110 Series, MPP, European Union and APAC, 1880 - 1900 MHz, Continental Europe Power Adapter
DBS-110-3PC-AU-K9=	Cisco IP DECT Base Station 110 Series, MPP, Australia and New Zealand, 1880 - 1900 MHz - Reduced power 22dBm, Australia Power Adapter
DBS-110-3PC-UK-K9=	Cisco IP DECT Base Station 110 Series, MPP, United Kingdom, 1880 - 1900 MHz, United Kingdom Power Adapter
DBS-210-3PC-NA-K9=	Cisco IP DECT Base Station 210 Series, MPP, U.S. and Canada, 1920 - 1930 MHz, North America Power Adapter
DBS-210-3PC-CE-K9=	Cisco IP DECT Base Station 210 Series, MPP, European Union and APAC, 1880 - 1900 MHz, Continental Europe Power Adapter
DBS-210-3PC-AU-K9=	Cisco IP DECT Base Station 210 Series, MPP, Australia and New Zealand, 1880 - 1900 MHz - Reduced power 22dBm, Australia Power Adapter
DBS-210-3PC-UK-K9=	Cisco IP DECT Base Station 210 Series, MPP, United Kingdom, 1880 - 1900 MHz, United Kingdom Power Adapter



Follow the instructions provided in the *Cisco IP DECT 6800 Series Administration Guide* to register the base stations to the call control system and register the handsets to the base stations.

## Site Survey

Each installation site is different even if it is one of a group of retail or restaurant locations built with the same plan. Create a site map to identify the best location to mount the base station.

The site map must identify the RF attenuation materials and RF interference sources as described in the previous sections. The Site Survey tool helps to identify the actual coverage received as Radio Signal Strength Indication (RSSI).

One base station can provide an indoor coverage radius of less than 50 meters (164 feet) depending on the site map and the attenuation characteristics of the materials in the line of sight.

The DECT base station must be placed in the center of the active work area in the building with a line of sight to all the coverage area.

### Site Survey Tool

Preparing for the survey:

1. Power on the DBS-210 base station and wait until the LED on the top of the base station lights green.
2. Power on the 6825 handsets. Ensure that the battery is fully charged before entering the site survey.
3. Put the handset into **Site Survey** mode.

Figure 12: The Cisco DECT Phone 6825 Handset



Legend for Figure 12:

1. Indicator light (LED)
2. Emergency Button
3. Headset port
4. Softkeys, phone control buttons (**Speaker, Menu**), Navigation cluster (Navigation ring and **Select** button, call control buttons (**Answer/Send, Power/End**))
5. Keypad
6. **Volume** and **Mute** buttons

Preparing for the survey with the handset:

1. Press **Menu**.
2. Press **\*47\***.

3. Press the **Select** button to select the base station

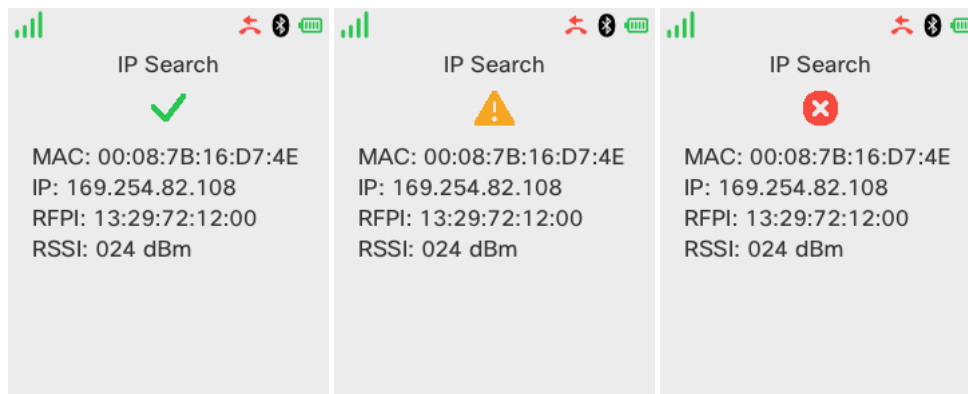
If more than one base station is listed, find the desired station with its MAC address. The handset displays the signal strength from the base station.

Figure 13: IP Search Screen



4. Move around the building to confirm the coverage area of this base station. The handset automatically updates the signal strength to the base station. The strength is shown as a green check mark, orange triangle, or red circle. The update may take a few seconds to synchronize with the base station. If there is no connection, the base station won't appear in the list.

Figure 14: IP Search screen with Good, Weak, and Poor



The following describes the items listed in the IP Search screen.

ID	Description	Purpose
MAC	MAC of the base station	If multiple base stations are available, this identifies the base station.
IP	IP address of the base station	
RFPI	Radio Fixed Part Identity	Identifies the RFPI of the base station.

ID	Description	Purpose
RSSI	Received Signal Strength Indicator	Indicates the received signal strength in decibel-milliwatt.

The following describes the RSSI Value:

RSSI Value	Indication of Quality
Greater than -50 dBm	Excellent
-50 dBm up to -70 dBm	Very Good
-70 dBm up to -80 dBm	Minimum required for a good call
Less than -80 dBm	Poor

In the area of Minimum quality RSSI, Cisco recommends that you add more base station or move the existing base station to improve the coverage in the desired area.

### Install the Base Stations

For the Single cell, Dual Cell and Multi-cell installation, this section provides the best practices for the direction and placement of the base station in the selected location.

The antennas are omnidirectional. Follow these recommendations for optimal signal coverage:

- Place the base station in the center of the desired coverage area for optimal coverage.
- Place the base station at least 2 meters (6.5') above the floor, so that the line of sight is maximized for all of the desired coverage area.

### Installation Caveats

- Don't install the base station on a metal rack. The coverage is reduced by the metal.
- Don't install the base station at the end of the room unless the desired coverage area is only at that end.
- Don't install a base station in the basement floor or on a table in the basement and expect coverage to the first floor.
- Don't install a base station behind a metal door (including an elevator) if the coverage area is on the other side of the door.
- Don't place the base station near high attenuation materials, such as metal and concrete, as this reduces the RSSI value as displayed on the handset.
- Don't place the base station inside electrical boxes or closets. The base station must be clearly visible in the working area. Use the ceiling mounting kits if the space is limited on the walls or flat surfaces



## Troubleshooting

For information about troubleshooting, see the *Troubleshooting* section in the *Cisco IP DECT 6800 Series Administration Guide* available on *Cisco.com*.

## Rerun the Site Survey

After installing the base stations, rerun the site survey to ensure that you have good coverage throughout the entire working area of your site.

## Completion

Install the handsets at each user's work location or in a common area if they are shared. Your Cisco IP DECT 6800 Series system is now ready for your users.

## Upgrade from old firmware

If the call control is WxC, power on the base station in factory reset mode. WxC will automatically upgrade the base station to its desired firmware.

For non-WxC in case, if you have base station with older firmware such as 470 or below, to go to 5.1(1) or above, it needs to follow a certain path to reach the desired firmware. Here is the configuration that achieves the path.

Base station can be in any version from 450 B4, 450 B8, 460 B5, 470 B6, 480 B12, 480 B17, 480 B22, 5.0(1) B17, 5.0(1) B19. Push the following configuration to the base station.

```
<Upgrade_Rule> http://cisco_server_1/DBS-210-3PC_v0480_b0022 </Upgrade_Rule> !- First
go to 480 B22, if base station version is 450, 460, 470, 480 or 5.0(1)

<Upgrade_intermediate_1_>DBS-210-3PC_v0480_b0022.fwu; https://cisco.com/path2/DBS-
210-3PC_v0500_b0119.fwu </Upgrade_intermediate_1_> !- Then go to 5.0(1) B19

<Upgrade_intermediate_2_>DBS-210-3PC_v0500_b0119.fwu; https://cisco.com/path2/DBS-
210-3PC-05-01-01-0001-07.fwu </Upgrade_intermediate_2_> !- Then go to 5.1(1) B7

<Upgrade_intermediate_3_>DBS-210-3PC-05-01-01-0001-07.fwu;
https://cisco.com/path2/DBS-210-3PC-05-01-01-0001-07.fwu </Upgrade_intermediate_2_> !-
Stay in 5.1(1) B7
```

After base station reaches the desired firmware, handsets will normally be upgraded directly to the desired firmware.

## Abbreviations

For the purpose of this document, the following abbreviations are used:

- DHCP: Dynamic Host Configuration Protocol
- TFTP: Trivial File Transfer Protocol
- IOS: Internetworking Operating System

NAT: Network Address Translator  
PCMA: A-law Pulse Code Modulation  
PCMU: mu-law Pulse Code Modulation  
RSSI: Received signal strength indication  
RTP: Real-time Transport Protocol  
RPORT: Response Port (RFC3581)  
SIP:Session Initiation Protocol  
SMB: Small and Medium Business  
STUN: Session Traversal Utilities for NAT  
VLAN: Virtual Local Access Network  
TOS: Type of Service (policy-based routing)  
URL: Uniform Resource Locator  
UA:User Agent  
UTC: Coordinated Universal Time (similar to GMT format)

## References

[Cisco IP DECT 6800 Series with Multiplatform Firmware Documentation](#)

- Use this page to find the End User Guides, Maintain and Operate Guides, and other useful documentation.