

OCTOBER 2022
05-0991-300

Xerox[®] W130 / W110 Scanner

Scanner User Guide for Microsoft[®] Windows.

Design © 2022 Xerox Corporation. All rights reserved. Xerox® is a registered trademark of Xerox Corporation in the United States and/or other countries and are used under license from Xerox Corporation. Visioneer is a trademark licensee of Xerox®. BR37050

Content © 2022 Visioneer, Inc. All rights reserved. The Visioneer brand name and OneTouch® logo are registered trademarks of Visioneer, Inc.

Reproduction, adaptation, or translation without prior written permission is prohibited, except as allowed under the copyright laws. Copyright protection claimed includes all forms of matters of copyrightable materials and information now allowed by statutory or judicial law or hereinafter granted, including without limitation, material generated from the software programs which are displayed on the screen such as styles, templates, icons, screen displays, looks, etc.

Document Version: 05-0991-300 (October 2022)

ISIS® is a registered trademark of EMC2® Corporation in the United States and/or other countries.

Adobe®, Adobe® Acrobat®, Adobe® Reader®, and the Adobe® PDF logo are registered trademarks of Adobe Systems Incorporated in the United States and/or other countries.

Post-It® is a registered trademark of 3M in the United States and/or other countries.

Microsoft is a U.S. registered trademark of Microsoft Corporation. Windows™ and SharePoint® are registered trademarks of Microsoft Corporation.

ZyINDEX is a registered trademark of ZyLAB International, Inc. ZyINDEX toolkit portions, Copyright © 1990-1998, ZyLAB International, Inc.

TWAIN™ is a trademark of TWAIN Working Group.

Intel® and Pentium® are trademarks of Intel Corporation in the United States and/or other countries.

Universal Serial Bus is a trademark of USB Implementers Forum, Inc. (USB-IF).

Kensington® is a registered trademark of ACCO Brands Corporation.

All other products mentioned herein may be trademarks of their respective companies and are hereby acknowledged.

Changes are periodically made to this document. Changes, technical inaccuracies, and typographic errors will be corrected in subsequent editions. Information is subject to change without notice and does not represent a commitment on the part of Visioneer.

The software described is furnished under a licensing agreement. The software may be used or copied only in accordance with the terms of such an agreement. It is against the law to copy the software on any medium except as specifically allowed in the licensing agreement. No part of this document may be reproduced or transmitted in any form or by any means, electronic or mechanical, including photocopying, recording, or information storage and retrieval systems, or translated to another language, for any purpose other than the licensee's personal use and as specifically allowed in the licensing agreement, without the express written permission of Visioneer.

Restricted Rights Legend

Use, duplication, or disclosure is subject to restrictions as set forth in contract subdivision (c)(1)(ii) of the Rights in Technical Data and Computer Software Clause 52.227-FAR14. Material scanned by this product may be protected by governmental laws and other regulations, such as copyright laws. The customer is solely responsible for complying with all such laws and regulations.

Table of Contents

| | |
|--|-----|
| 1-Safety | 1-1 |
| Safety Introduction..... | 1-1 |
| Operational Safety Information | 1-1 |
| Electrical Information | 1-2 |
| Warning - Electrical Safety Information..... | 1-2 |
| Electrical Supply..... | 1-2 |
| Disconnect Device | 1-3 |
| Emergency Power Off | 1-3 |
| Maintenance Information | 1-3 |
| Product Safety Certification..... | 1-3 |
| Environmental Health and Safety Contacts | 1-4 |
| 2-Welcome | 2-1 |
| What's in the Box..... | 2-1 |
| System Requirements | 2-1 |
| Documentation..... | 2-2 |
| Xerox® W130..... | 2-3 |
| 3-Scanner Setup..... | 3-1 |
| Connect the Scanner Power Cord | 3-2 |
| 4-The Scanner's LCD..... | 4-1 |
| The Scanner LCD and Button Panel..... | 4-1 |
| The Scanner LCD's Main Screen | 4-1 |
| Network Status On The LCD..... | 4-1 |
| The Scanner LCD's Menu | 4-2 |
| Accessing the scanner LCD menu..... | 4-2 |
| 5-PC Installation | 5-1 |
| Install the Software and Connect the Scanner..... | 5-1 |
| Installing the Scanner Driver | 5-3 |
| Connect the USB Cable and Turn on the Power | 5-4 |
| Installing Visioneer OneTouch..... | 5-6 |
| Installing Additional Applications | 5-6 |
| View the User Guides | 5-7 |
| Register Your Scanner | 5-8 |
| 6-Wired Network Connection..... | 6-1 |
| Connecting to the Network using a Ethernet LAN Cable (Wired) | 6-1 |
| Connecting the Scanner for Use on the Cloud Server | 6-1 |

| | |
|--|------|
| Using a Network Connected Scanner from your PC..... | 6-2 |
| 7-Installation for Use on Your Mobile Device..... | 7-1 |
| Accessing the mobile scanning apps using your mobile device..... | 7-1 |
| 8-Loading Documents to Scan..... | 8-1 |
| Supported Document Types..... | 8-1 |
| Documents to Avoid Scanning..... | 8-2 |
| Unsupported Document Types..... | 8-2 |
| Select the Paper Feeding Options..... | 8-2 |
| Select the Paper Path..... | 8-3 |
| Scanning from the Automatic Document Feeder (ADF)..... | 8-3 |
| Preparing Documents for Scanning..... | 8-3 |
| Loading Documents..... | 8-4 |
| Scanning Interfaces..... | 8-4 |
| 9-The Scanner's Web Interface..... | 9-1 |
| Accessing the Scanner's Web Interface..... | 9-1 |
| Information..... | 9-2 |
| Support..... | 9-3 |
| Network..... | 9-3 |
| Host Name..... | 9-3 |
| Wired..... | 9-3 |
| Network Security Setup..... | 9-4 |
| Device Management..... | 9-6 |
| VAST Network..... | 9-6 |
| Local..... | 9-6 |
| Cloud..... | 9-7 |
| Advanced Security..... | 9-9 |
| Changing your Login Credentials..... | 9-13 |
| 10-Scanner Options, Maintenance and Troubleshooting..... | 10-1 |
| Safety Precautions..... | 10-1 |
| Hardware Properties..... | 10-1 |
| Device Settings..... | 10-2 |
| Driver Settings..... | 10-4 |
| Clearing Paper Jams..... | 10-4 |
| Cleaning the Scanner..... | 10-4 |
| Cleaning the Outside of the Scanner..... | 10-5 |
| Cleaning the Inside of the Scanner..... | 10-5 |
| Cleaning the ADF Rollers..... | 10-6 |
| Cleaning the Scanner Glass and Background Plates..... | 10-7 |

| | |
|--|-------|
| Cleaning the Paper Sensors..... | 10-7 |
| Cleaning the ADF Sensors..... | 10-8 |
| Replacing the Rollers | 10-8 |
| Replacing the Pick Up Rollers | 10-9 |
| Replacing the Paper Feed Rollers..... | 10-10 |
| Replacing the Double feed Roller | 10-12 |
| Scanner Status Message Table..... | 10-12 |
| Installing an Ink Cartridge | 10-17 |
| | 10-18 |
| Adjusting the Printing Position | 10-19 |
| Troubleshooting | 10-19 |
| Uninstalling Your Scanner..... | 10-21 |
| Xerox® W130 / W110 Scanner Specifications..... | 10-22 |
| Xerox® W130 / W110 Scanner Parts List | 10-23 |
| 11-Appendix A: Regulatory Information | 11-1 |
| Basic Regulations | 11-1 |
| United States (FCC Regulations) | 11-1 |
| European Union..... | 11-1 |
| Turkey (RoHS Regulation) | 11-2 |
| Copy Regulations | 11-2 |
| United States | 11-2 |
| Canada | 11-3 |
| Other Countries..... | 11-4 |
| 12-Appendix B: Compliance Information | 12-1 |
| Product Recycling & Disposal | 12-1 |
| USA & Canada | 12-1 |
| European Union..... | 12-1 |
| ENERGY STAR for the USA..... | 12-1 |

1. Safety

Safety Introduction

Notices and Safety

Please read the following instructions carefully before operating the machine and refer to them as needed to ensure the continued safe operation of your machine.

Your Xerox® product and supplies have been designed and tested to meet strict safety requirements. These include safety agency evaluation and certification, and compliance with electromagnetic regulations and established environmental standards.



The safety and environment testing and performance of this product have been verified using Xerox® materials only. Unauthorized alterations, which may include the addition of new functions or connection of external devices, may impact the product certification. Please contact your Xerox representative for more information.

Operational Safety Information

Your Xerox® equipment and supplies have been designed and tested to meet strict safety requirements. These include safety agency examination, approval, and compliance with established environmental standards.

To ensure the continued safe operation of your Xerox® equipment, follow these safety guidelines at all times:

Do these:

- Always follow all warnings and instructions that are marked on or supplied with the equipment.
- Always use materials specifically designated for this product, the use of other materials may result in poor performance and create a hazardous situation. Do not use aerosol cleaners, they may be explosive and flammable under certain conditions.
- Always exercise care when moving or relocating equipment.
- Always locate the machine on a solid support surface that has adequate strength to support the weight of the machine.
- Always locate the machine in an area that has adequate ventilation and room for servicing.
- Always unplug this equipment from the electrical outlet before cleaning.

Note: Your Xerox® machine is equipped with an energy saving device to conserve power when the machine is not in use. The machine may be left on continuously.

Do not do these:

- Never use a ground adapter plug to connect the equipment to a power outlet that lacks a ground connection terminal.

- Never attempt any maintenance function that is not specifically described in this documentation.
- Never remove covers or guards that are fastened with screws. There are no operator serviceable areas within these covers.
- Never locate the machine near a radiator or any other heat source.
- Never override or “cheat” any of the electrical or mechanical interlock devices.
- Never place this equipment where people might step on or trip on the power cord.



Caution: This device is not intended for use in the direct field of view at visual display workplaces.

To avoid incommoding reflections at visual display workplaces this device must not be placed in the direct field of view.

Electrical Information

WARNING - ELECTRICAL SAFETY INFORMATION

1. The power receptacle for the machine must meet the requirements stated on the data plate on the rear of the machine. If you are not sure that your electrical supply meets the requirements, please consult your local power company or an electrician for advice.
2. The socket outlet shall be installed near the equipment and shall be easily accessible.
3. Use the power cable that is supplied with your machine. Do not use an extension cord or remove or modify the power cord plug.
4. Plug the power cable directly into a correctly grounded electrical outlet. If you are not sure whether or not an outlet is correctly grounded, consult an electrician.
5. Do not use an adapter to connect any Xerox® equipment to an electrical outlet that lacks a ground connection terminal.
6. Do not place this equipment where people might step or trip on the power cable.
7. Do not place objects on the power cable.
8. Do not override or disable electrical or mechanical interlock devices.
9. Do not push objects into slots or openings on the machine. Electrical shock or fire may result.

ELECTRICAL SUPPLY

- This product shall be operated from the type of electrical supply indicated on the product's data plate label. If you are not sure that your electrical supply meets the requirements, please consult your local power company for advice.



- Always connect equipment to a correctly grounded power outlet. If in doubt, have the outlet checked by a qualified electrician.



WARNING: This equipment must be connected to a protective earth circuit

This equipment is supplied with a plug that has a protective earth pin. This plug will only fit into an earthed electrical outlet. This is a safety feature. If you are unable to insert the plug into the outlet, contact your electrician to replace the outlet.

DISCONNECT DEVICE

The power cable is the disconnect device for this equipment. It is attached to the side of the machine as a plug-in device. To remove all electrical power from the equipment, disconnect the power cable(s) from the electrical outlet.

Emergency Power Off

If any of the following conditions occur, turn off the machine immediately and disconnect the power cable(s) from the electrical outlet(s).

- The equipment emits unusual odors or makes unusual noises.
- The power cable is damaged or frayed.
- A wall panel circuit breaker, fuse, or other safety device has been tripped.
- Liquid is spilled into the machine.
- The machine is exposed to water.
- Any part of the machine is damaged.

Maintenance Information

1. Any operator product maintenance procedures will be described in the user documentation supplied with the product.
2. Do not carry out any maintenance on this product which is not described in the customer documentation.
3. Do not use aerosol cleaners. The use of cleaners that are not approved may cause poor performance of the equipment, and could cause a dangerous condition.
4. Use supplies and cleaning materials only as directed in this manual.
5. Do not remove covers or guards that are fastened with screws. There are no parts behind these covers that you can maintain or service.
6. Do not perform any maintenance procedures unless you have been trained to do them by an authorized local dealer or unless a procedure is specifically described in the user manuals.

Product Safety Certification

This product is certified by the following Agency using the Safety standards listed:

| STANDARD |
|-------------------------------|
| UL60950-1 (USA) |
| CSA 22.2 No. 60950-1 (Canada) |
| IEC 60950-1 |

Environmental Health and Safety Contacts

Contact Information

For more information on Environment, Health, and Safety in relation to this Xerox® product and supplies, please contact the following customer help lines:

| |
|--|
| North America & Europe (Phone): 1-800-ASK-XEROX |
| North America & Europe (Fax): 1-585-422-8217 |

2. Welcome

Your new Xerox® W130 / W110 Scanner can quickly scan stacks of single-sided or double-sided pages and place their electronic images on your computer.

The information in this guide will cover hardware and software features that may not be available for the scanner model you purchased. Please disregard any information that does not apply to your scanner.

What's in the Box

Before proceeding, check the contents of the box. If items are missing or damaged, contact the dealer where you purchased the scanner.

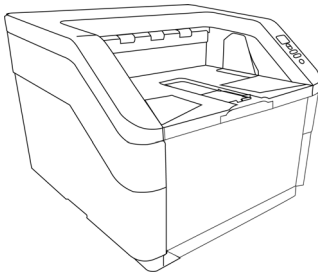

Xerox® W130 / W110 Scanner

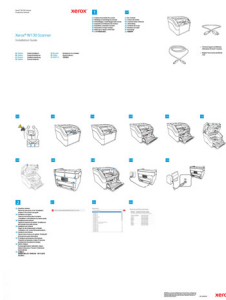

Installation Guide

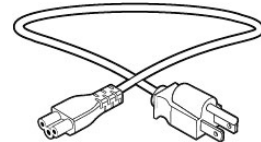

Power Cord



USB Cable

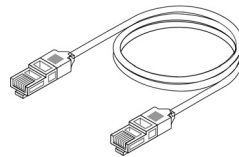

Ethernet Cable (For W130 scanners only)

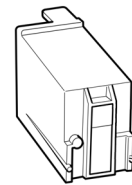

Imprinter Cartridge (For W130 scanners only)

- Technical Support and Warranty Information
- Register Your Scanner and Review Card

System Requirements

- Intel i3 or equivalent CPU
- Internet access (for installation only)
- An available Universal Serial Bus (USB) port
- Microsoft® Windows® operating system:
 - 32-bit or 64-bit Windows 7 (Service Pack 1)
 - 32-bit or 64-bit Windows 10

- 32-bit or 64-bit Windows 11
- Minimum of 2 gigabyte (GB) of internal memory (RAM)
- Minimum available hard disk space:
 - 350 MB for the scanner driver
 - 1 GB for Visioneer OneTouch
 - 1 to 3 GB for each additional application

A VGA or SVGA Monitor:

- The recommended settings for your monitor are:
 - Color quality of 16-bit or 32-bit
 - Resolution set to at least 800 x 600 pixels

Refer to your Windows documentation for instructions on setting the color quality and resolution for the monitor.

Documentation

The following printed documentation is provided in the box:

- **Installation guide**—abbreviated scanner setup and installation instructions.
- **Technical Support and Warranty Information**—contact information for technical support and customer service, and a brief overview of our standard product warranty.
- **Register your scanner and review card** — follow the instructions on the card to register your scanner. Please take a moment to write a short review of your experience with this scanner.

The following soft-copy documentation is available during installation or on www.xeroxscanners.com:

- **Scanner user guide**—instructions for scanner setup, installation, operation, maintenance, safety, and warranty
- **OneTouch scanning guide**—instructions for configuring and scanning using OneTouch
- **TWAIN scanning guide**—instructions for accessing and scanning using the TWAIN interface
- **Patch code sheets**—use with an application that supports detection of patch code data when using the TWAIN interface. The patch code page layouts have been specifically designed for your scanner. The file contains Patch 2, 3 and T layouts for A4 and U.S. Letter size pages.

Xerox® W130

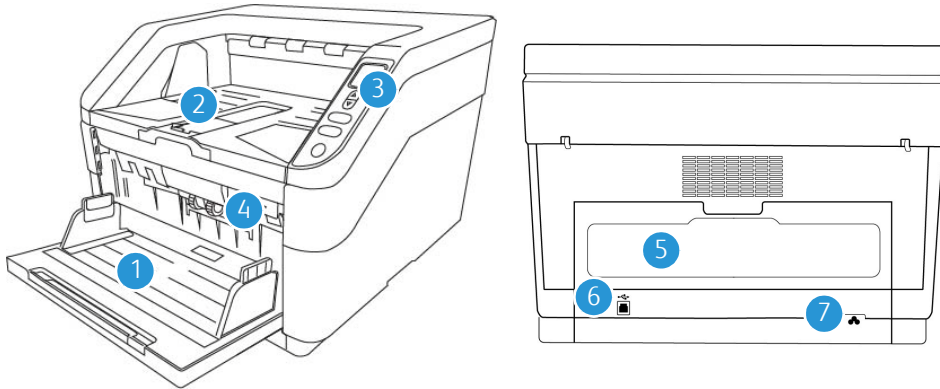

1. **Input tray**—Holds the documents in the Automatic Document Feeder for scanning.
 - **Extension**—Pull out to support various document lengths.
 - **Paper Guides**—Slide to adjust to document width.
2. **Exit tray**—Where the documents are exited out of the scanner. Flip up an exit stopper to keep documents in the exit tray. Exit extension pulls out to support various document lengths.
3. **Control panel**—Scanner hardware controls
 - **LCD Screen**—Shows the current scan settings.
 - **Function arrows**—Select the scan setting for the OneTouch buttons. Press the up or down arrow to cycle through the settings.
 - **Simplex button**—Press to scan single-sided documents.
 - **Duplex button**—Press to scan double-sided documents.
 - **Status light/Power button**—Turns the scanner’s power on/off and indicates the scanner’s status..
4. **ADF cover release**—Pull to open the Automatic Document Feeder.
5. **Straight path door**—Lower this door to feed very thick pages straight through the scanner.
6. **Universal Serial Bus (USB) port**—Connects the scanner to the computer.
7. **Power jack**—Connects the power cord to the scanner.s

3. Scanner Setup

1. Remove the scanner from the shipping box, verify all parts listed on page 2-1 are in the box.
We recommend that you keep the original packing materials in case you need them later.
2. Always have at least two people carry the scanner, lifting the scanner up from underneath.
3. Use a desk or table that can support the weight of the scanner, do not place the scanner on a cloth covered surface.
4. Place the scanner on a level surface near the computer.
5. Remove any shipping tape from the scanner as indicated in the following illustration(s).

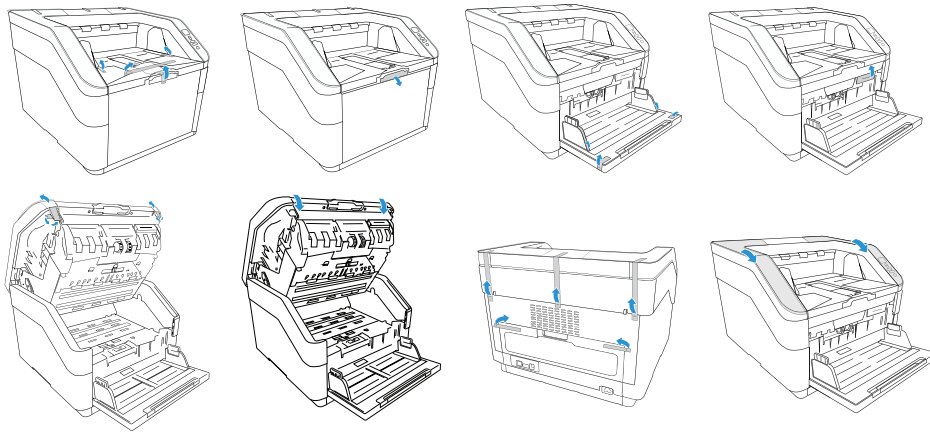

The illustrations are for example purposes only. Your scanner's packaging may vary slightly.

6. Release the tray door to open the input tray. Pull the output tray from the scanner.

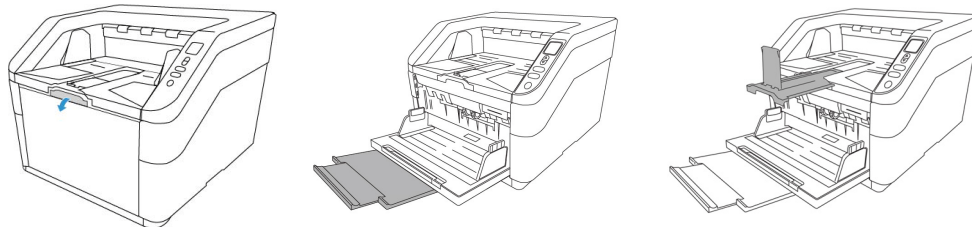

Connect the Scanner Power Cord

Note: Only use the power supply included with your scanner. Connecting any other type of power supply may damage your scanner, and will void its warranty.

1. Select the appropriate power cord for your country.
2. Plug the power cord into the power port on the scanner.
3. Plug the power cord into a wall outlet.

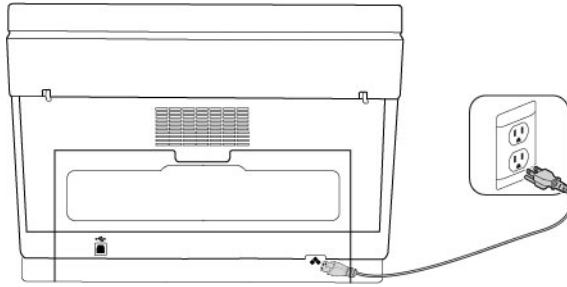

4. The Scanner's LCD

The information in this guide will cover hardware and software features that may not be available for the scanner model you purchased. Please disregard any information that does not apply to your scanner.

The scanner's LCD displays scanning information. It also allows you to access a menu to enable LAN, view scanner information, put the scanner in "clean mode" and quickly download the Visioneer Mobile Capture mobile app (iOS and Android) and quickly register your scanner for use with VAST Network.

THE SCANNER LCD AND BUTTON PANEL

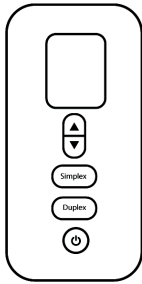

The Scanner LCD's Main Screen

This screen will appear once driver installation is complete. The LCD can be slightly different. The example below appears once OneTouch is installed. You can find the drivers in [The Scanner's Web Interface's Support](#) page. If you are using the scanner with a PC, you can also refer to [PC Installation](#).

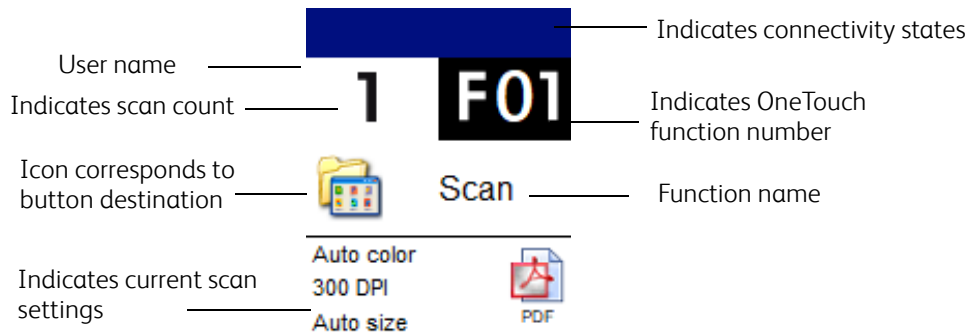

NETWORK STATUS ON THE LCD

You can observe network connectivity quickly from the scanner's LCD.



If you see this symbol, the scanner is connected via USB cable.



If you see this symbol, the scanner is connected to the network using an ethernet cable (LAN)



If you see this symbol, the scanner is connected to VAST Network.

For more information on network connectivity, see [Wired Network Connection](#).

The Scanner LCD's Menu

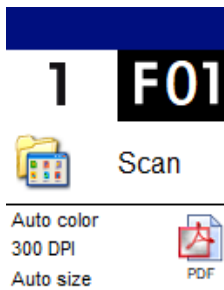

The scanner's LCD menu allows you to enable LAN, view scanner information, put the scanner in "clean mode", reset the scanner to factory default and quickly download the Visioneer Mobile Capture mobile app (iOS and Android) and quickly register your scanner for use with VAST Network.

ACCESSING THE SCANNER LCD MENU

1. Hold the Simplex and Duplex buttons for more than two seconds to access the LCD scanner menu.
2. Use the up and down arrows to navigate to navigate through the menu.
3. Use the Duplex button to confirm your selection.
4. Use the Simplex button to go Back in the menu.

| Scanner LCD Menu Options | |
|--------------------------|--|
| LAN | |
| On/Off | If enabled, the scanner is set up to communicate with your computer (or any other device) over a wired network. The scanner and the device should be connected to the router or hub using an Ethernet cable. For advanced settings see The Scanner's Web Interface > Wired . |
| Information | |
| Scanner | <p>Displays the following:</p> <ul style="list-style-type: none"> • Model Name This is the current scanner model. • FW Version This is the version of the currently installed firmware on the scanner. • S/N (Serial Number) This is the scanner's serial number. This is unique to every scanner <p>SW (Software) Versions</p> <p>Note: These may not be present if the scanner is being used with the mobile apps only.</p> <ul style="list-style-type: none"> • Driver This is the version of the currently installed driver. • Acuity This is currently installed Acuity version. • OT4 (OneTouch) This is the version of the currently installed OneTouch. <p>This information can be helpful when calling for Technical Support.</p> |

| Scanner LCD Menu Options | |
|--------------------------|--|
| Ethernet | |
| IP Address | If connected to a wired network (LAN), the IP address will be displayed here. For advanced settings see The Scanner's Web Interface > Wired . |
| MAC Address | The MAC address is displayed here. For advanced settings see The Scanner's Web Interface > Wired . |
| DHCP | Displays if DHCP is enabled or disabled. For advanced settings see The Scanner's Web Interface > Wired . |
| Counters | |
| Total | Displays the total amount of scans the scanner has performed. |
| ADF Roller | Displays the total number of times the roller has been used. This roller must eventually be replaced, see Replacing the Rollers . |
| Separation Roller | Displays the total number of times the roller has been used. This roller must eventually be replaced, see Replacing the Rollers . |
| Cleaned | Displays the number of scans since rollers were last cleaned. |
| Clean Mode | |
| | Used to rotate the rollers during cleaning. See Cleaning the ADF Rollers . |
| Factory Default | |
| |  WARNING: Pressing the Duplex button on this option will reset all scanner settings to factory default, including those set on The Scanner's Web Interface. |
| Register | |
| | Used to register the scanner for use with VAST Network. For more information see Connecting the Scanner for Use on the Cloud Server . |

5. PC Installation

Please make sure of the following before you begin installation:

- If you are prompted to reboot during installation, please select No. Finish installing the rest of the software, then close all open windows and reboot your computer.
- The information in this guide may cover software not provided with the scanner you purchased. Please disregard any information about the software not applicable to your scanner.
- If your computer has antivirus or antispyware software running, you may encounter alerts or messages during installation asking you to allow the installation to proceed. Although the messages will differ based on the software your computer is running, in each case you should allow the installation to proceed if that option is available. Alternatively, you can turn off the antivirus or antispyware software before installing your scanner, but if you do, make sure to turn it back on again when installation is finished.
- If your computer is running Windows 7 or later, you may see the Windows User Account Control screen asking you to confirm system changes. Click the Yes button to allow the installation to proceed.

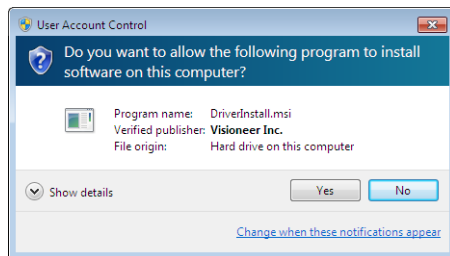

Installation

1. Start Microsoft Windows and make sure that no other applications are running.
2. Turn on the scanner's power.

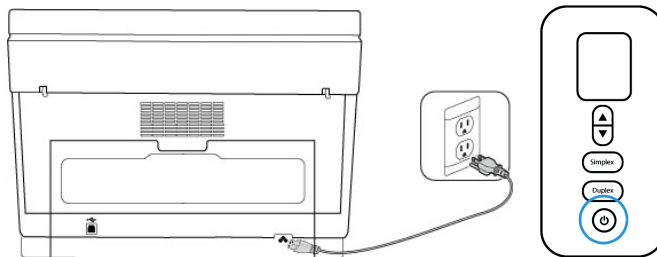

The status light comes on and flashes indicating that the scanner is receiving power.

3. Go to www.visioneer.com/install.
4. Launch the installer once the download is complete.

5. Plug the USB cable into the USB port on the scanner then into a USB port on the computer.

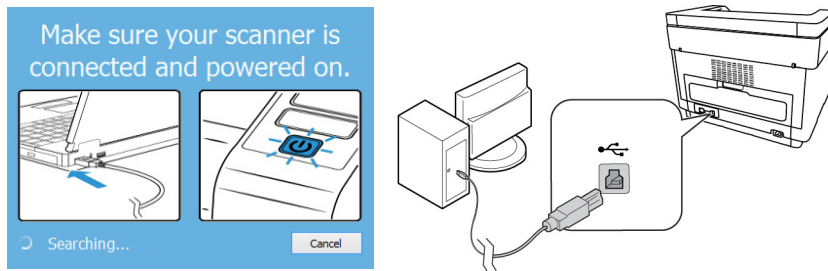

6. Click **OK**.
7. Select your scanner from the list.

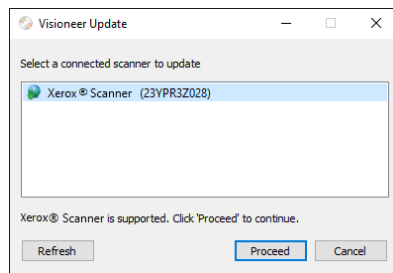

8. Click **Proceed**.
9. The Select Language window opens. Click the drop-down menu arrow and select the language to use. Click **OK**.

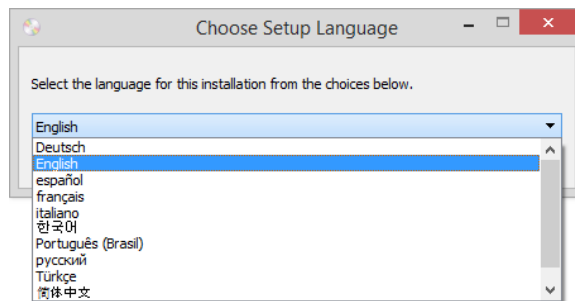

10. Make sure the boxes for **Scanner Driver** and **Visioneer OneTouch** are selected, as well as any other applications you want to install.

Note: The software provided with your scanner may differ slightly from the list shown in the window. If a version of the software is already installed on the system, the option will be greyed out. However, if there is a newer version available online, it will be possible to download and install.

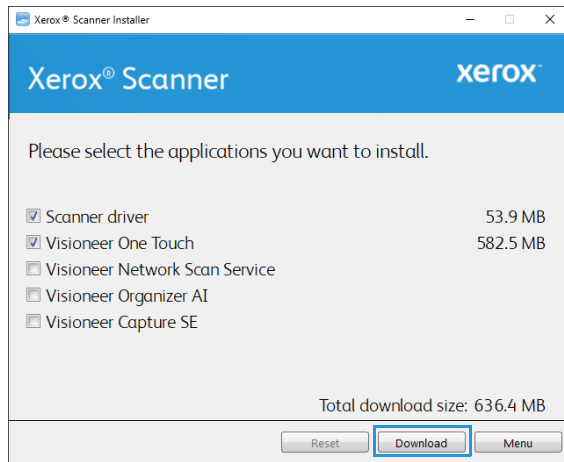

The software will have to first be downloaded by clicking **Download**. The total size of the download is shown at the bottom.

11. After the download has begun, it can be paused. If changes to the selections are required, it is necessary to click **Reset** while the download is paused. This will allow the settings to be changed.

Note: Clicking the Reset button in either the Main menu or the Install menu will cause both partially completed and previously downloaded files to be deleted. In order to be installed they will have to be downloaded again.

12. Once all software has been downloaded, click **Install**.
13. On the License Agreement windows, read the license agreements. If you accept the terms, select **I Agree**. If you choose not to accept the license agreement, the installation will terminate.

View the User Guides

1. From the Main menu and click on **View user guides**.

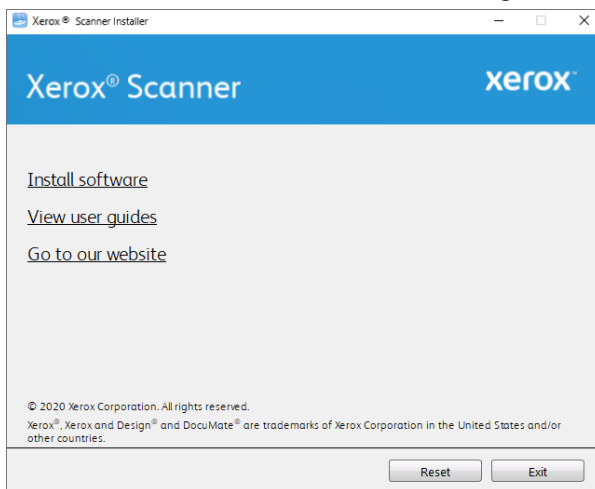

2. Click on **View scanner documentation** to access the scanner user guide and scanning guides for OneTouch and TWAIN.

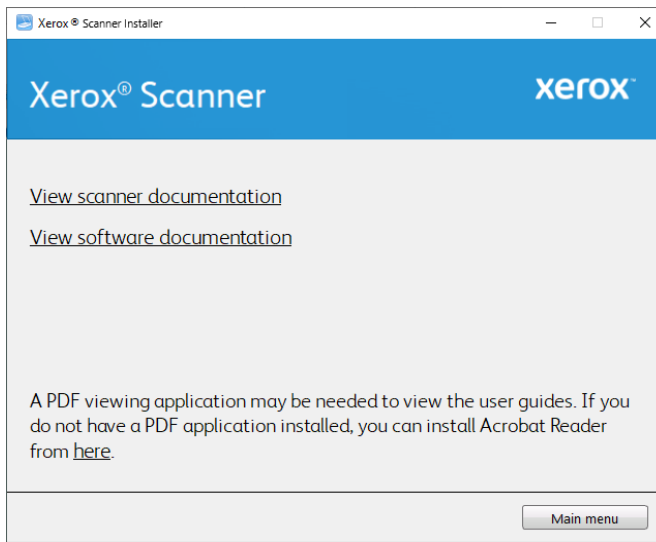

3. Click the links of the guides you want to view.

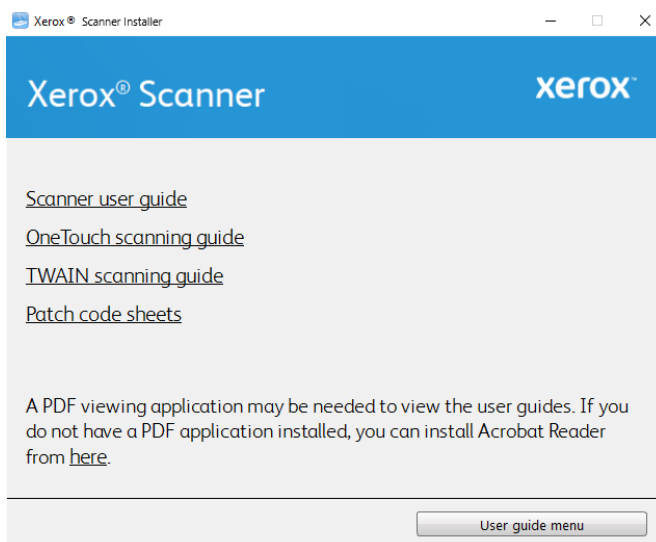

Click on the **User guide menu** button to return to the main user guide window, then select the other documentation section to view the user guides.

- **Scanner user guide**—Instructions for scanner setup, installation, operation, maintenance, safety, and warranty
 - **OneTouch scanning guide**—Instructions for configuring and scanning using OneTouch
 - **TWAIN scanning guide**—Instructions for accessing and scanning using the TWAIN interface
4. When you're finished, click **Main menu** to return to the Main menu window and click **Exit**.

Register Your Scanner

Registering your scanner is important as it provides you with access to our free telephone support service. Registration also gives you free access to software updates for your scanner.

You will need an active network connection to register your scanner. If you do not have network access you can contact our customer service department to register the scanner. Please refer to the Technical Support Card, that you received with the scanner, for our customer service contact information.

1. Open an Internet Explorer window, or any other Internet browser you have installed on your computer.
2. In the web address field type www.xeroxscanners.com.
3. Press Enter on your computer's keyboard or click the option on screen to go to the web address.
4. When the Xerox® scanners web page loads click on **Register Your Product**.
5. Fill in the registration form, all required fields have an asterisk (*).
A valid email address is required for registration.
6. You will be asked to enter the serial number for the scanner, it is located on the back or underside of the scanner.
7. After filling in the form, click on **Submit Your Registration** to complete the registration.

6. Wired Network Connection

The information in this guide will cover hardware and software features that may not be available for the scanner model you purchased. Please disregard any information that does not apply to your scanner.

If the scanner is connected to the network, it is available to use wirelessly with your mobile apps, on a shared network with Visioneer Network driver or with any TWAIN Direct compliant application.

Connecting to the Network using a Ethernet LAN Cable (Wired)

1. Connect one end of an ethernet LAN cable to an available port of your ethernet hub.
2. Connect the other end to the port marked at the back of the product.

Note: For advanced settings, go to [The Scanner's Web Interface](#), see [Wired Network Connection](#).

Connecting the Scanner for Use on the Cloud Server

Skip these steps if your scanner and your device (PC or mobile device) are connected to the same network.

This feature allows you to use the scanner remotely from any network-connected PC.

Note: The scanner must be connected to the internet and registered on the Cloud Server.

1. Launch the camera on your mobile device.
2. Hold the Simplex and Duplex buttons for more than two seconds to access the LCD scanner menu.
3. Use the up and down arrows to select the **Register** option.

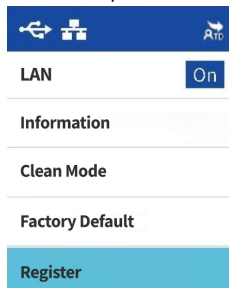

4. The LCD will display a message that registration is started.

5. Scan the QR code that appears on the scanner LCD.



6. To complete registration, you will be redirected to the Cloud Service sign in.
7. Sign in to the Cloud Service using your Microsoft or Google account.

The scanner will now be registered on the Cloud Service with your account. You can now access the scanner on the iOS or Android mobile apps or Visioneer Network Scanner Manager.

Note: You will need to sign in with the same account that registered the scanner on the Cloud Server before using the scanner on any of the aforementioned applications. See the Visioneer Mobile Capture user guide for more information, www.xeroxscanners.com.

There is a registration token number above the QR code. You can use this to register the scanner using any device by browsing to www.twaindirect.visioneer.com. Log in with your Microsoft or Google account and click **Add** to add a scanner.

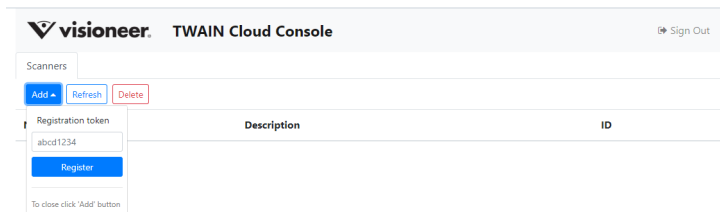

Alternatively, you connect the scanner to the Cloud Server from [The Scanner's Web Interface](#).

Using a Network Connected Scanner from your PC

Once a network connection is established, you can use the scanner wirelessly on a network-connected device.

1. Ensure the scanner and network-connected device are on the same network.
Alternatively, you can register the scanner to the Cloud Server and then connect it to the PC using Visioneer Network Scanner Manager.
2. Install scanner driver (see [PC Installation](#)) and Visioneer Network Driver (see Visioneer Network Driver user guide).

3. Launch Visioneer Network Scanner Manager.

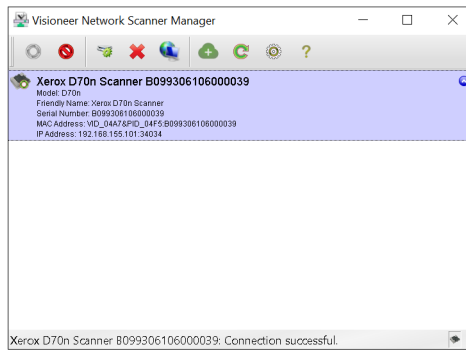

4. Select an available scanner from the list.
5. Connect the scanner.
6. It is now ready for use with OneTouch, TWAIN or WIA on your network-connected device.

Note: If using the scanner in a shared network, it is recommended that you disconnect when it is not in use.

See the Visioneer Network Driver user guide for additional information, www.xeroxscanners.com.

7. Installation for Use on Your Mobile Device

Download the iOS or Android mobile scanning app to use a mobile device with this scanner to scan and share documents.

Accessing the mobile scanning apps using your mobile device

Quickly download the mobile scanning app for Android or Apple.

1. Hold the Simplex and Duplex buttons for more than two seconds to access the LCD scanner menu.
2. Use the up and down arrows to select the **Information** option.
3. Use the Duplex button to confirm your selection.
4. Use the up and down arrows to select the **Support** option.
5. Use the Duplex button to confirm your selection.
6. Use your mobile device's camera to scan the QR code on the scanner's LCD screen.
7. Support site will open.
8. Proceed with the app installation accordingly.

The links to the mobile apps can also be found on [The Scanner's Web Interface](#). See [Support](#).

8. Loading Documents to Scan

Always remove any staples or paper clips from documents before inserting them into the scanner. Staples and paper clips can jam the feed mechanism and scratch the internal components. Also remove any labels, stickers, or Post-It™ notes that may come off during the scanning process and get stuck in the scanner. Misuse as described here will void your scanner's warranty. Please go to www.xeroxscanners.com, select your product, and then click the "Warranty" link to view the warranty terms and conditions for your scanner.



Supported Document Types

You can scan the following types of documents with this scanner.

- Maximum amount of paper in the input tray
 - Approximately 500 pages of 7 ~ 28 lbs (27~105 g/m²) new printer paper
- Document size
 - Minimum size (width x length)
 - Single Page 1.97 x 2.56 inches (50 x 65 mm)
 - Multi Page 1.97 x 3.35 inches (50 x 85 mm)
 - Maximum size (width x length) – 12.1 x 17.0 inches (308 x 432 mm)
 - Maximum length with long document enabled – 236.0 inches (5994 mm)
We recommend scanning one page at a time when the documents you are scanning are longer than 17 inches (432 mm).
- Mixed document stacks
 - Scanner minimum to maximum without long document enabled
Arrange the documents so that all items are centered in the stack. The document sensor, paper separation, and feed rollers are located in the middle of the paper path. If smaller items are offset from the center they will not be detected. This will cause feeding issues and paper jams. The ratio between the smallest and largest page in the stack should be no more than 1.5.
- Page thickness
 - U-Turn Path: 27~105 g/m² (7 ~ 28 lbs)
 - Straight path: 27~ 413 g/m² (7 ~ 110lbs)

Documents to Avoid Scanning

The documents in this list can be scanned, but please note that scanning documents of this type will reduce the life of the scanner. Maintenance will be required more often and replaceable parts will wear faster. These types of documents will jam more frequently and damage to the original documents may occur. If you do choose to scan these document types, do not scan large batches. This type of use is not covered under the scanner warranty and alters replacement parts life expectancy.

We recommend you limit the amount or completely avoid scanning documents that are in this list.

- Curled, wrinkled or folded documents may cause paper jams or multiple pages being fed through the scanner at one time.
- Perforated or punched paper that could tear when the separation roller engages.
- Coated paper or photographs where the coating can flake off during scanning and leave residue in the scanner.
- Extremely smooth, shiny, or highly textured paper may cause the paper feed rollers to slip across the page and cause the scanner to report a paper jam.
- Carbonless copy paper may tear while being fed through the scanner and the pressure of the rollers may leave streaks on the page. The chemical coating on this paper will rub off on the rollers during the scan process, increasing the frequency of miss-feeds and paper jams.
- Partially transparent paper such as tracing paper as any images from the opposite side of the page or black background will appear in the scanned images.

Unsupported Document Types

Do not scan the following types of documents as they may cause damage to the scanner.

- Items outside of the specified supported sizes, thickness, and weight defined in this document.
- Non-rectangular or irregularly shaped paper will cause the scanner to detect and report document skew errors or paper jams.
- Carbon paper that will leave residue in the scanner and on the rollers that will transfer to the next set of documents scanned.
- Documents with hard items attached such as paper clips, binder clips, and staples.
- Documents with wet ink or white-out.
- Thermal or photosensitive paper.
- Overhead projector sheets, plastic film, camera film, and any other type of transparent or partially transparent plastic item.
- Documents that have been glued together.
- Cloth or metallic sheets.

Select the Paper Feeding Options

There are paper feed options that you can adjust using the scanner control panel. Adjust this options based on the type of documents you are scanning.

Tray Adjust — this adjusts the height of the input tray based on the amount of paper in the input tray. The scanner will automatically raise the tray during scanning, but if you regularly scan small batches of paper, you may want to keep the input tray higher to save time adjusting the height automatically while scanning.

Press and hold the Simplex and Duplex buttons to open the scanner LCD menu. Use the arrow buttons to get to Tray Adjust and use the Duplex button to confirm the selection. For Tray Adjust, use the arrow buttons to select between 50, 125, 250, 375, 500 (default) sheets. Pressing the Duplex button will confirm user selection and return to the main operational screen.

Select the Paper Path

Scanned documents can be exited to the output tray in the front of the scanner or to the straight path tray in the back of the scanner. The paper path is automatically switched when the straight path is opened or closed.

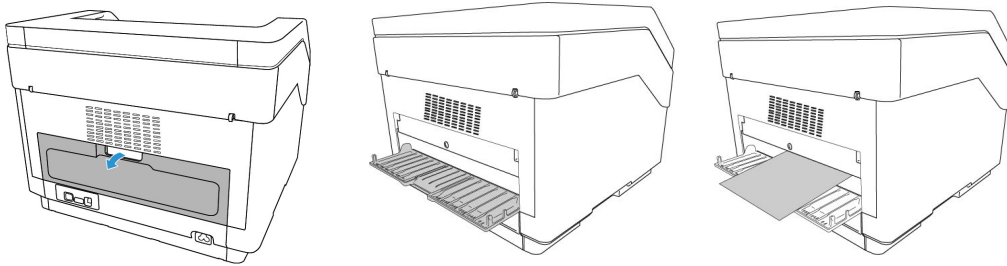

Note: follow these guidelines when using the straight path tray.

- Use the straight path tray when using a higher paper thickness level.
- Make sure there is enough space in the back of the scanner for the paper to exit.

Scanning from the Automatic Document Feeder (ADF)

PREPARING DOCUMENTS FOR SCANNING

- Fan the documents to make sure all pages in the stack are separated.
- Bend and then flatten the document stack to make sure the horizontal edges are aligned to help prevent paper from skewing while being pulled through the scanner.
- Pinch the ends to align the leading edges slantwise to help prevent multiple pages from being fed through at a single time.

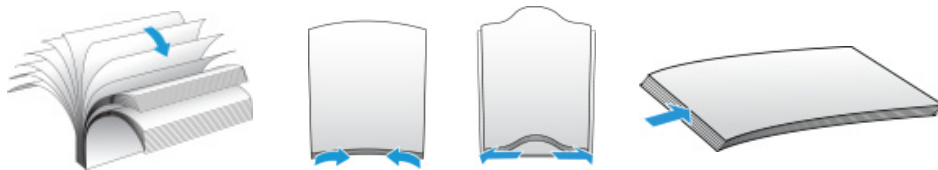

LOADING DOCUMENTS

1. Adjust the paper guides to the width of the document you want to scan. Extend the input tray and output tray to the length of the document.

Flip up the paper stop to make sure the paper stays in the output area as they are exited from the scanner.

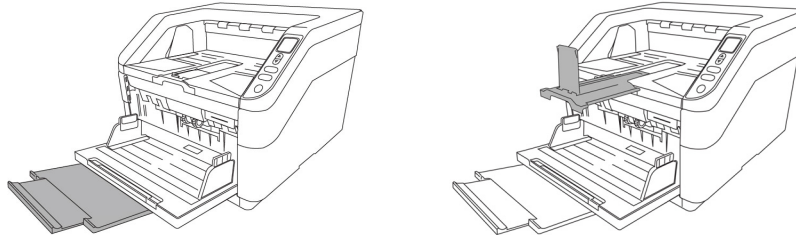

2. Load the documents *face up* with their tops into the Automatic Document Feeder. The stack of pages should not exceed the maximum height indicated on the input tray.

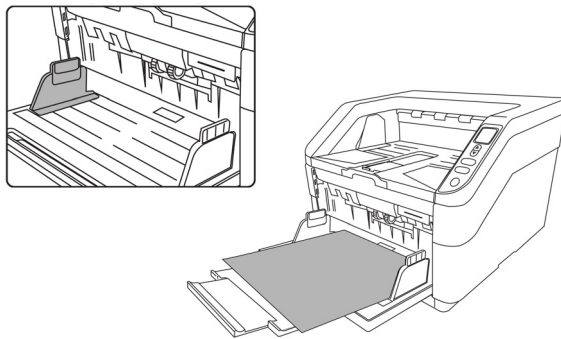

3. You can now scan the documents using the scanner button, OneTouch, or one of the other scanning interfaces.

Scanning Interfaces

- **OneTouch Control Panel**—When you press the Simplex/Duplex button on the scanner, the documents are scanned using the scans settings for the first OneTouch scan function. The scanned image is then sent to a destination on your computer or network drive.

- OneTouch Button Panel**—Scanning from the on-screen OneTouch Button Panel is the same as pressing the Simplex/Duplex button on the scanner, except you click an icon that represents the function.

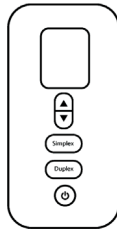

Scanner Control Panel

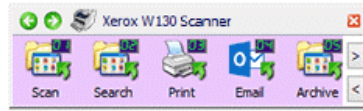

OneTouch Button Panel

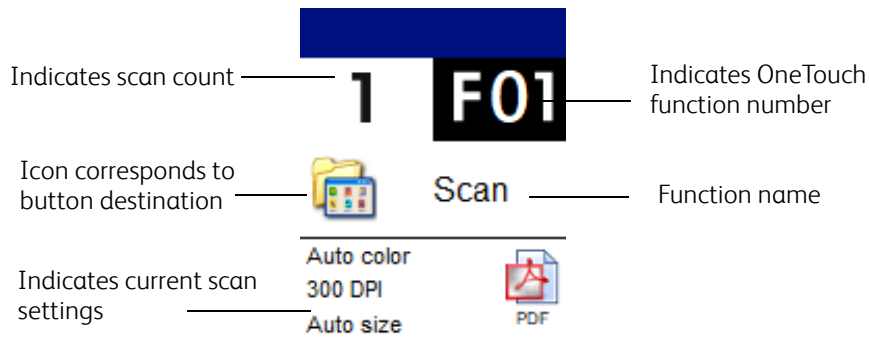

Please see the OneTouch Scanning Guide, available online, for instructions. You can also click the **Help** button in the OneTouch Properties window to open the instructions in an Internet browser.

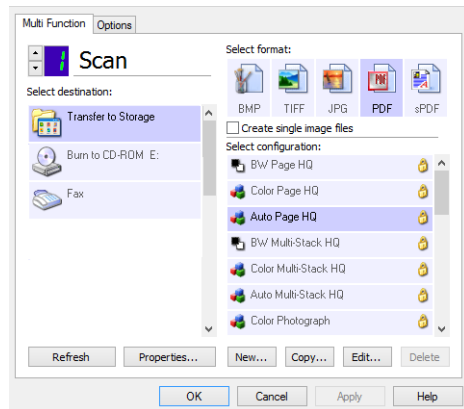

- **TWAIN and WIA Interface**—This option uses your scanner’s TWAIN interface to scan. Select scanning options before scanning, put the document in the scanner, then click the **Scan** button in the TWAIN interface window.

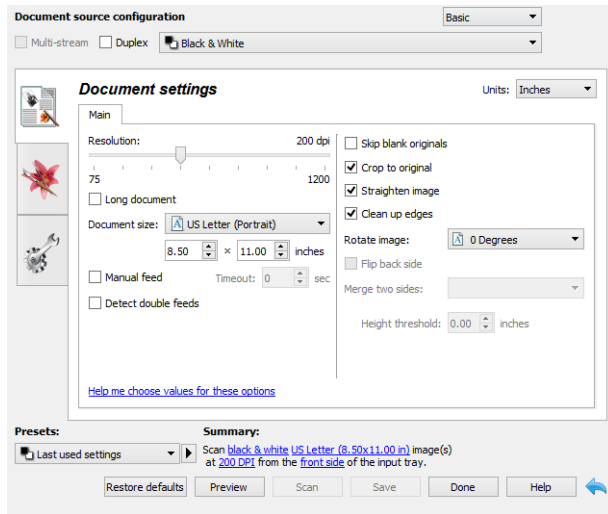

Please see the TWAIN Scanning Guide, available online, for instructions. You can also click the **Help** button in the TWAIN interface to open the instructions in an Internet browser.

- **ISIS Interface**—This option uses the ISIS interface for scanning. Please refer the user manual for your ISIS scanning application for instructions on scanning with the ISIS interface.

9. The Scanner's Web Interface

Accessing the Scanner's Web Interface

To access the Scanner's Web Interface, you will first need to locate the IP Address.

Finding the IP Address

This is your scanner's IP address. It is used to access the Scanner's Web Interface.

1. Hold the Simplex and Duplex buttons for more than two seconds to access the LCD scanner menu.
2. Use the up and down arrows to select the **Information** option.
3. Use the Duplex button to confirm your selection.
4. Use the up and down arrows to select the **LAN** option.
5. Use the Duplex button to confirm your selection.
6. Use the arrow buttons to navigate to **IP Address**.

The Simplex button can be used as a Back button to navigate the LCD Scanner Menu.

With an established connection (see [Wired Network Connection](#)):

1. Open your browser.
2. Type the IP address of the scanner in the URL field of your browser and then press enter on your keyboard.
3. The scanner's embedded web page appears.

The screenshot displays the Xerox W130 Scanner web interface. At the top, there is a navigation bar with the Xerox logo and the text "Xerox W130 Scanner". On the right side of the navigation bar, there are "Admin" and "Logout" buttons. Below the navigation bar, there is a "Menu" sidebar on the left with options: Information, VAST Network, Device Management, Network, Firmware Update, and Support. The main content area is titled "Information" and contains a "Scanner" section. This section lists various scanner metrics and their current values:

| | | | |
|-------------------|--------------------|---------------------------|-------|
| Model Name: | Xerox W130 Scanner | ADF Simplex Count: | 22424 |
| Host Name: | Xerox-0E0000 | ADF Duplex Count: | 49859 |
| First Scan: | 2019/8/5 | Multi-Feed Count: | 5008 |
| Serial Number: | A095385495240002 | Jam Count: | 246 |
| Firmware Version: | 8.08 | Optical Resolution: | 600 |
| Born Date: | 2019/8/5 | Background color: | White |
| Operating time: | 3525hr(s) 15min(s) | Count since last cleaned: | 6059 |
| | | Feed Roller Count: | 6059 |
| | | Separation Roller Count: | 6059 |
| | | Pickup Roller Count: | 6059 |

Each of the four "Count" rows has a "Reset Counter" button to its right. Below the "Scanner" section, there is a "Network" section with a "Wired" subsection. The "Wired" subsection shows the IP Address as 192.168.155.111 and the MAC Address as 00:00:64:0e:00:00.

4. To access complete information of the web interface, click on the **Login** button and enter the default **Login Name: admin** and **Password: admin**. See [Changing your Login Credentials](#).

Information

xerox Xerox W130 Scanner Admin Logout

Menu

- Information
- VAST Network
- Device Management
- Network
- Firmware Update
- Support

Information

Scanner

| | | | |
|-------------------|--------------------|---------------------------|---|
| Model Name: | Xerox W130 Scanner | | |
| Host Name: | Xerox-0E0000 | ADF Simplex Count: | 22424 |
| First Scan: | 2019/8/5 | ADF Duplex Count: | 49859 |
| Serial Number: | A096385495240002 | Multi-Feed Count: | 5008 |
| Firmware Version: | 8.08 | Jam Count: | 346 |
| Born Date: | 2019/8/5 | Optical Resolution: | 600 |
| Operating time: | 3525hr(s) 15min(s) | Background color: | White |
| | | Count since last cleaned: | 6059 <input type="button" value="Reset Counter"/> |
| | | Feed Roller Count: | 6059 <input type="button" value="Reset Counter"/> |
| | | Separation Roller Count: | 6059 <input type="button" value="Reset Counter"/> |
| | | Pickup Roller Count: | 6059 <input type="button" value="Reset Counter"/> |

Network

Wired

IP Address: 192.168.155.111
MAC Address: 00:00:64:0e:00:00

| Item | Description |
|--------------------|--|
| Scanner | |
| Model Name | Displays the scanner model name. |
| Host Name | Displays the product's host name. |
| Serial Number | Displays the scanner's serial number. |
| Firmware Version | Displays the currently installed firmware version. |
| Born Date | Displays the scanner's original manufacturing date. |
| Scan Count | Displays the scan count for the Reverse Roller, Pick-up and Separation Roller, ADF Simplex Count, ADF Duplex Count, Multi-Feed, Clean Count, and Paper Jams count. Reset Roller Count: Click this button to reset roller count after roller has been replaced. |
| Optical Resolution | Displays the optical resolution set for this scanner. |
| Background | Describes the background color of the scanner. |
| Network | |
| Wired | Used to show the product's IP and MAC address in a wired network environment. |

Support

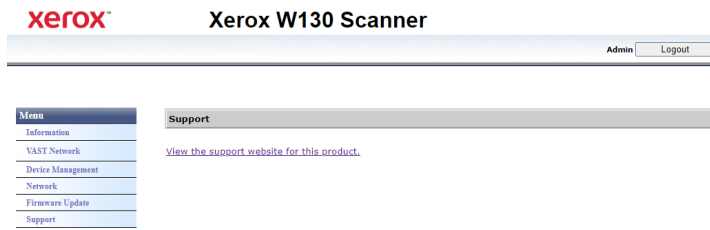

| Item | Description |
|---------|---|
| Drivers | Links to scanner's support page. Download scanner drivers for use on your PC. You can also access scanner and software manuals. |

Network

HOST NAME

Displays the scanner's host name. You can customize this name.

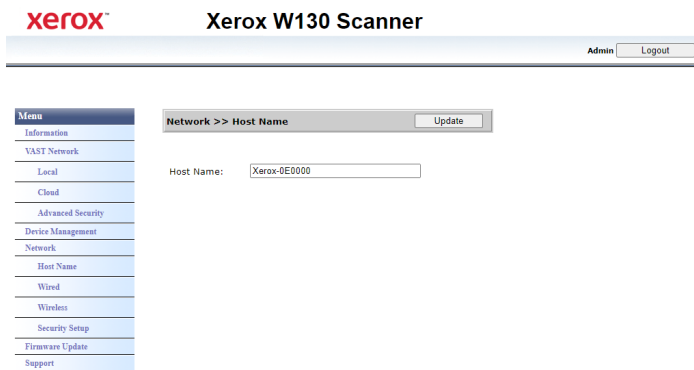

Changing the host name

Make sure you are logged in to the [The Scanner's Web Interface](#). By default: **Login Name: admin** and **Password: admin**. To customize these credentials, see [Changing your Login Credentials](#).

1. From the menu go to the **Network** tab.
2. Then from its sub menu, go to the **Host Name** tab.
3. In the **Host Name** field, enter the desired display name.
4. Click **Update**.
5. A prompt message will appear confirming that the request was successfully processed.
6. Click **OK**.

WIRED

Overview of the scanner's current wired (LAN) settings.

By default, **Obtain an IP address automatically** is set to **On**. To customize these settings (advanced), select **Off** from the dropdown menu. All disabled fields will be enabled.

If the scanner is connected to the network, it is available to use wirelessly with your mobile apps, on a shared network with Visioneer Network Driver or with any TWAIN Direct compliant application.

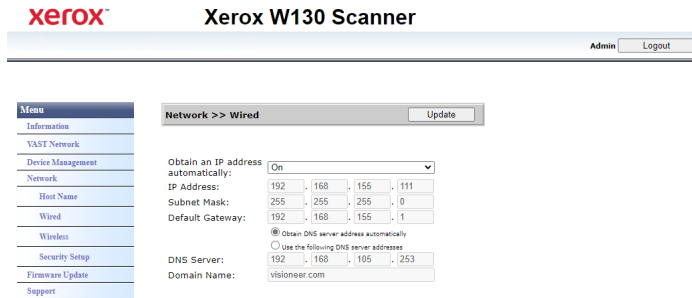

NETWORK SECURITY SETUP

Web Server Settings

Allows an authorized Administrator to enable or disable HTTPS access to Web Interface.

1. After changing the Web Server Settings and pressing Update, refresh your browser by entering the correct web address prefix in the address bar.
2. The Scanner Certificate needs to be installed on client machine by the Administrator in order to avoid security messages from the browsers.

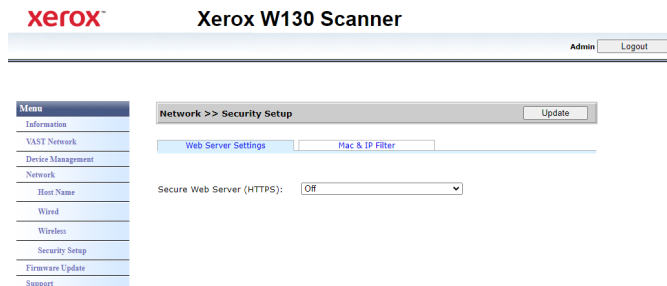

MAC & IP Filtering

The devices contain a static host-based firewall that prevents unauthorized network access based on IP address Mac address. Filtering rules can be set by the Administrator using the Web Interface. An authorized Administrator can create rules to (filter / allow) for ALL or a range of IP addresses. In addition, an authorized Administrator can specify Mac addresses to filter/allow.

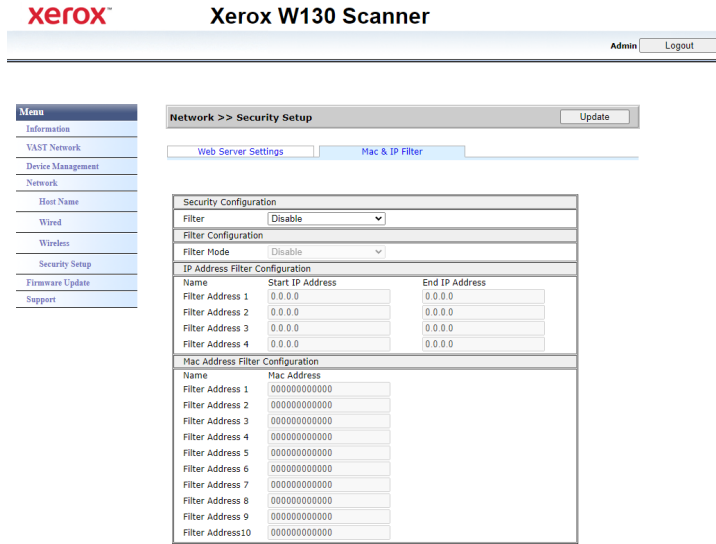

1. To Enable/Disable Filtering, use "Filter" control.
2. To change which address to be allowed or filtered use "Filter Mode" control. When it is set to "Disable" all the addresses or range of addresses will be filtered. When it is set to "Enable", only the addresses or range of addresses specified will be allowed. All others will be filtered.
3. To filter a single IP address, enter it in both "Start IP Address" and "End IP Address" controls.
4. To filter a range of IP addresses, specify start and end address.
5. Maximum of 5 IP address ranges can be specified
6. To filter a MAC address enter it in one of the 10 rows of the MAC Address table.
7. Press the "Update" button to save your settings.

Device Management

| Item | Description |
|----------------------|--|
| Admin Profile | |
| Login Name | Specify a login name. This will be used to access the web interface or locked files. By default, it is set to: admin |
| Password | Specify a login name. This will be used to access the web interface or locked files. By default, it is set to: admin |

VAST Network

This section is specific to VAST Network.

LOCAL

This is the scanner's name displayed on the VAST Network application.

Changing the scanner's display name:

Make sure you are logged in to the [The Scanner's Web Interface](#). By default: **Login Name: admin** and **Password: admin**. To customize these credentials, see [Changing your Login Credentials](#).

1. From the menu go to the **VAST Network** tab.
2. Then from its sub menu, go to the **Local** tab.

3. In the **Scanner Description** field, enter the desired scanner display name.
4. Click **Update**.
5. A prompt message will appear confirming that the request was successfully processed.
6. Click **OK**.

CLOUD

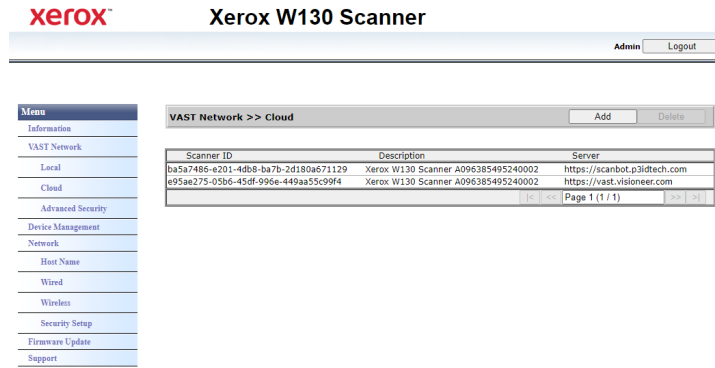

| | |
|-------------|---|
| Scanner ID | This is a unique identification number associated to your scanner. This cannot be changed. This is used for VAST Network cloud service to recognize and differentiate your scanner. |
| Description | This is the scanner's name and serial number. This matches the scanner description set in Local . |
| Server | This is the URL of the VAST Network Cloud Service. |

Registering a new scanner to the VAST Network Cloud

Make sure you are logged in to the [The Scanner's Web Interface](#). By default: **Login Name: admin** and **Password: admin**. To customize these credentials, see [Changing your Login Credentials](#).

1. From the menu go to the **VAST Network** tab.
2. Then from its sub menu, go to the **Cloud** tab.
3. Click **Add**.

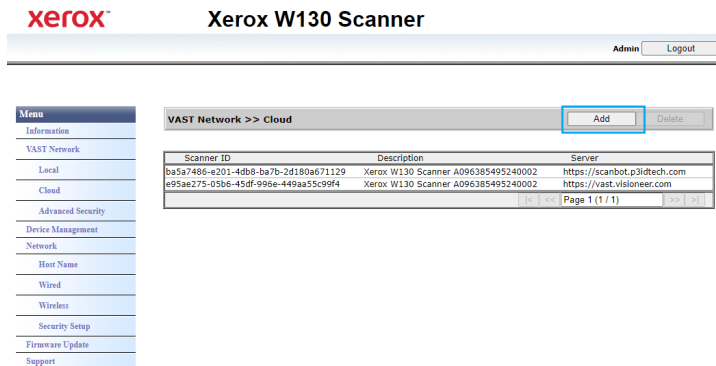

- Enter the scanner description as indicated in [Local](#).

- Enter the VAST Network cloud service URL: <https://vastnetwork.visioneer.com> or any other cloud service link you wish to connect to.
- Click **Register**.
- To confirm the registration, you must login to the cloud service. Click **Login**.

- A new tab will open in your browser and you will be redirected to the cloud service.

- Login to complete registration.

ADVANCED SECURITY

Digital Signatures

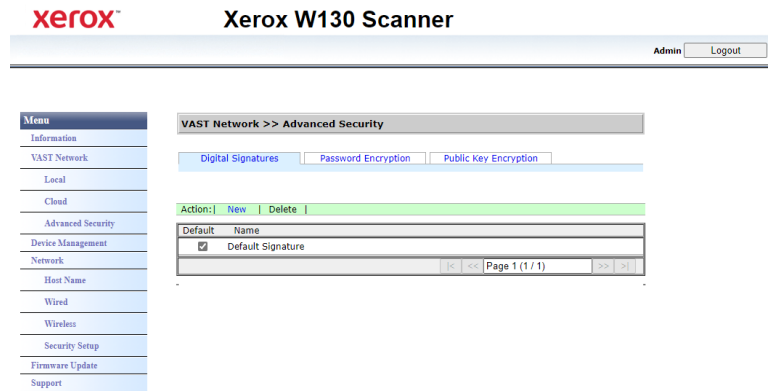

| | |
|---------|---|
| Default | Check the box to make the Digital Signature default. |
| Name | This is the Digital Signature's name as set. See Adding a public key encryption profile . |

Adding a new digital signature

Make sure you are logged in to the [The Scanner's Web Interface](#). By default: **Login Name: admin** and **Password: admin**. To customize these credentials, see [Changing your Login Credentials](#).

1. From the menu go to the **VAST Network** tab.
2. Then from its sub menu, go to the **Advanced Security** tab.
3. Go to the **Digital Signatures** tab.
4. Click **New**.

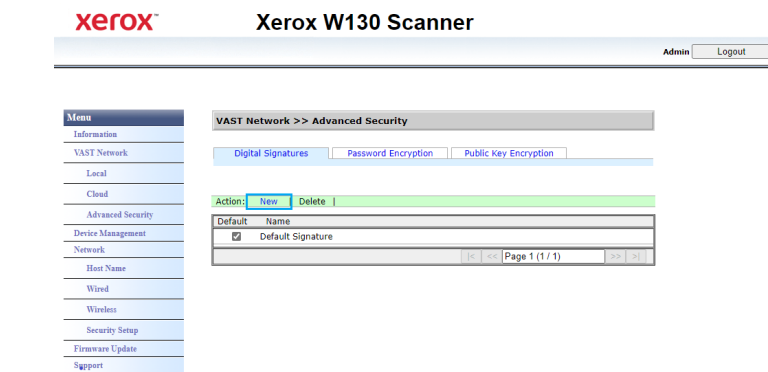

5. Enter a signature name, this is how it will be displayed in the **Digital Signature** window.
6. Select a PKS #12 file from your PC.
7. Enter a password to protect your digital signature.
8. Click **Upload**. If successful your new digital signature will be displayed in the **Digital Signatures** window.

Deleting a digital signature

Make sure you are logged in to the [The Scanner's Web Interface](#). By default: **Login Name: admin** and **Password: admin**. To customize these credentials, see [Changing your Login Credentials](#).

1. From the menu go to the **VAST Network** tab.
2. Then from its sub menu, go to the **Advanced Security** tab.
3. Go to the **Digital Signatures** tab.
4. Click on the digital signature you wish to remove. It will be highlighted.
5. Click **Delete**.

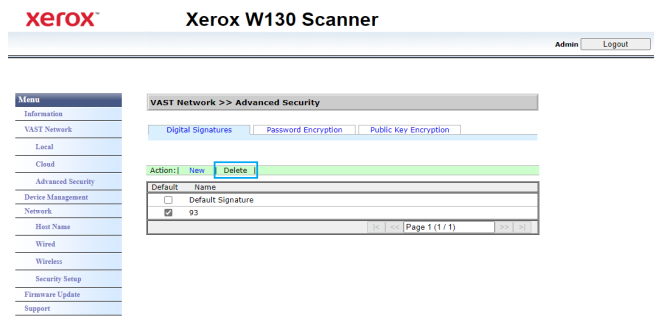

Note: This cannot be undone.

Password Encryption

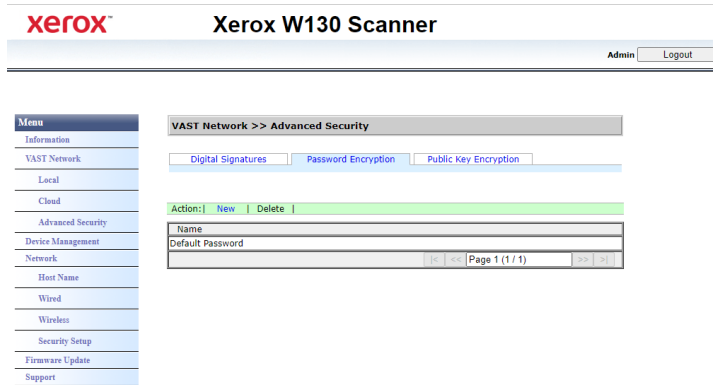

| | |
|------|--|
| Name | This is the Digital Signature's name as set. This is used to protect a file. When someone receives the file sent from VAST Network, they will need the User Password to view this file or the Owner Password to edit this file. See Adding a public key encryption profile . |
|------|--|

Adding a new password encryption

Make sure you are logged in to the [The Scanner's Web Interface](#). By default: **Login Name: admin** and **Password: admin**. To customize these credentials, see [Changing your Login Credentials](#).

1. From the menu go to the **VAST Network** tab.
2. Then from its sub menu, go to the **Advanced Security** tab.
3. Go to the **Password Encryption** tab.

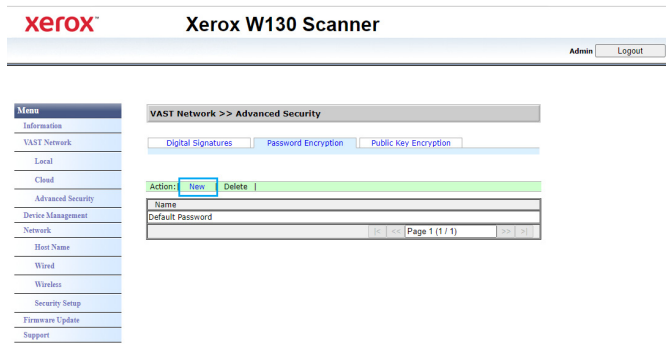
4. Click **New**.

5. Enter a name for the password encryption, this is how it will be displayed in the **Password Encryption** window.
6. Enter a **User Password**. This will be the password required to view the scanned files.
7. Enter a **Owner Password**. This will be the password required to edit the scanned files.
8. Click **Save**. If successful your new password encryption name will be displayed in the **Password Encryption** window.



Deleting a password encryption

Make sure you are logged in to the [The Scanner's Web Interface](#). By default: **Login Name: admin** and **Password: admin**. To customize these credentials, see [Changing your Login Credentials](#).

1. From the menu go to the **VAST Network** tab.
2. Then from its sub menu, go to the **Advanced Security** tab.
3. Go to the **Password Encryption** tab.
4. Click on the password encryption you wish to remove. It will be highlighted.

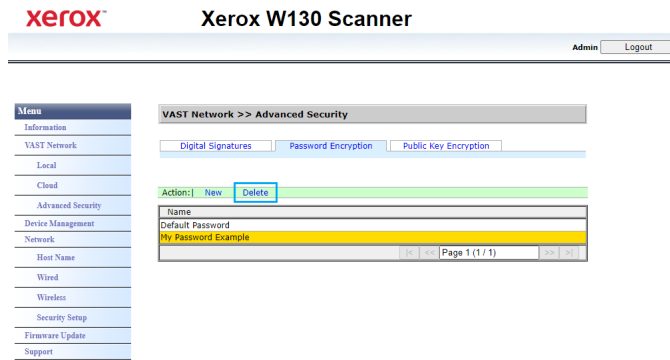
5. Click **Delete**.

Note: This cannot be undone.

Public Key Encryption

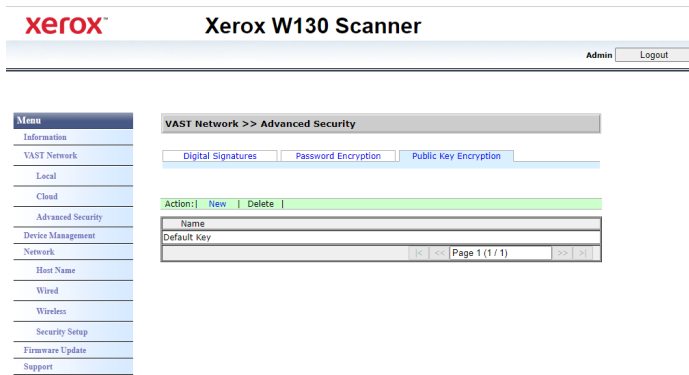

| | |
|------|--|
| Name | This is the Public Key profile name as set. This is used to protect the file. To decode the file the user needs the corresponding paired key. See Adding a public key encryption profile . |
|------|--|

Adding a public key encryption profile

Make sure you are logged in to the [The Scanner's Web Interface](#). By default: **Login Name: admin** and **Password: admin**. To customize these credentials, see [Changing your Login Credentials](#).

1. From the menu go to the **VAST Network** tab.
2. Then from its sub menu, go to the **Advanced Security** tab.
3. Go to the **Public Key Encryption** tab.

4. Click **New**.

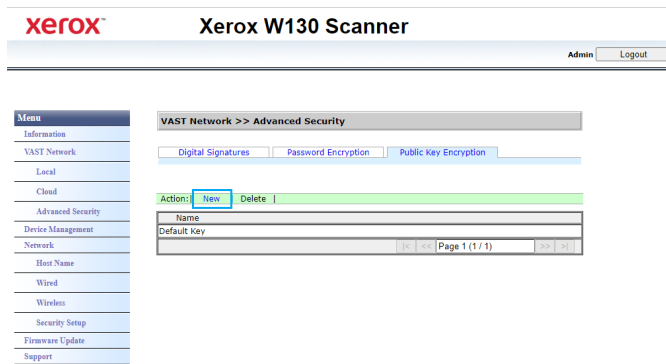

5. Enter a name, this is how it will be displayed in the **Public Key Encryption** window.
6. Select a .CER file from your PC.
7. Click **Upload**.
8. If successful, the new public key encryption profile will appear in the **Public Key Encryption** window.

Deleting a public key encryption profile

Make sure you are logged in to the [The Scanner's Web Interface](#). By default: **Login Name: admin** and **Password: admin**. To customize these credentials, see [Changing your Login Credentials](#).

1. From the menu go to the **VAST Network** tab.
2. Then from its sub menu, go to the **Advanced Security** tab.
3. Go to the **Public Key Encryption** tab.
4. Click on the public key encryption profile you wish to remove. It will be highlighted.
5. Click **Delete**.

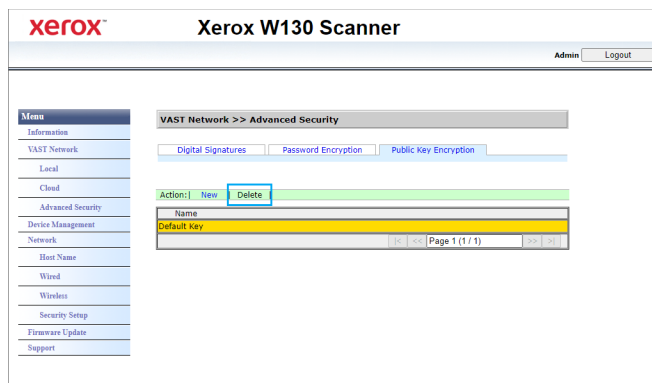

Note: This cannot be undone.

Changing your Login Credentials

Login to the [The Scanner's Web Interface](#), you are required to enter login information. By default: **Login Name: admin** and **Password: admin**.

You can personalize these credentials.

1. Login to [The Scanner's Web Interface](#) to see the advanced settings.
2. Go to the **Device Management** tab.

The screenshot shows the Xerox W130 Scanner web interface. At the top left is the Xerox logo, followed by the text "Xerox W130 Scanner". On the top right, there are "Admin" and "Logout" buttons. Below the header is a navigation menu on the left with the following items: Menu, Information, VAST Network, Device Management (highlighted), Network, Host Name, Wired, Wireless, Security Setup, Firmware Update, and Support. The main content area is titled "Device Management" and contains an "Update" button. Underneath, the "Admin, Profile" section is active, showing "Login Name:" with a text box containing "admin" and "Password:" with a text box containing "*****".

3. In the **Admin Profile** section, use the **Login Name** and **Password** text boxes to enter your new credentials.

10. Scanner Options, Maintenance and Troubleshooting

This section contains information on hardware options available for your scanner, maintenance instructions, troubleshooting, uninstalling, scanner specifications, and spare parts.

Safety Precautions

When servicing the scanner you should take the following precautions to ensure your safety and prevent damage to the scanner.

Do These

- Wear protective gloves when cleaning the scanner with isopropyl rubbing alcohol. Rubbing alcohol may irritate sensitive skin.
- Only perform scanner maintenance as described in this chapter.
- Keep the scanner and cleaning supplies away from any open flame or heat source as any form of alcohol is flammable.
- Always read the instructions in each section carefully, the instructions are specific to the part you are installing or servicing.
- Move the scanner to an area that has adequate room for opening the scanner.
- If your scanner has a power cord and/or power switch, always turn off the scanner and unplug the power cord before performing maintenance, unless the maintenance instructions below specifically state to leave the scanner plugged in and powered on.
- Always unplug the USB cable from the scanner before performing maintenance, unless the maintenance instructions below specifically state to leave the scanner plugged in.
- Wear an anti-static strap to prevent electrostatic discharge when touching metal components.
- Keep all cleaning supplies, scanner parts and accessories out of the reach of children.

Do Not Do These

- Never attempt installation of any part not described in this manual.
- Never service the scanner near a radiator or any other heat source.
- Never use aerosol sprays or compressed air, or attempt to lubricate parts with an oil or silicon spray.
- Never service the scanner in an area where there are open liquid containers.
- Never pour or spill liquid on the scanner or any of its components.

Hardware Properties

You can use the scanner's properties page to keep track of scanner maintenance, change some of the hardware options, configure the scanner interface behavior, and adjust application options that may be available for your scanner.

To open the scanner hardware properties page:

- **Windows 7** and later—from the Windows Control Panel, open **Hardware and Sound** and then **Devices and Printers**.

Right-click on the scanner and then select **Scan properties** from the list. Click **Yes** if you are prompted by the Windows User Account Control to confirm that you want make changes to the system settings.

DEVICE SETTINGS

The Device Settings tab shows the hardware information for your scanner. The options on the Device Settings tab will be available based on whether or not the scanner hardware supports the feature. Some features described herein may not be available for the current scanner. Please disregard any information about features that you do not see in the interface for your scanner.

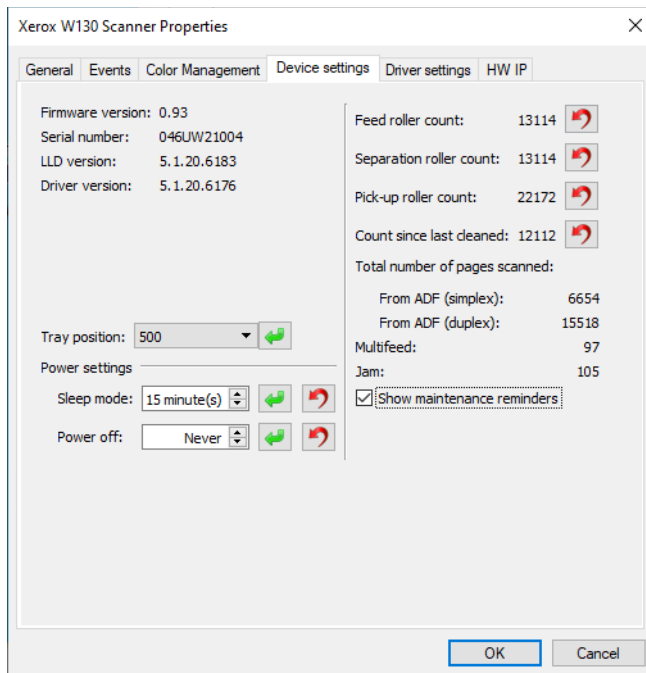
**Scanner Details**

- **Firmware version**—this is the scanner’s hardware processor version number.
- **Serial number**—the scanner’s unique identification number.
- **LLD version**—the scanner’s base driver version. This is not the OneTouch software revision, TWAIN or WIA driver versions.
- **Driver version**—this is the version of the scanner’s TWAIN driver.

To view Scanner and Software Details from the LCD Scanner Menu:

1. Hold the Simplex and Duplex buttons for more than two seconds to access the LCD scanner menu.
2. Use the up and down arrows to select the Scanner Details option.
3. Use the Duplex button to confirm your selection.
4. You can now view the scanner details; model name, firmware version, serial number.

5. To view software details, use the down arrow, as indicated on the LCD menu. The LCD will display: driver version, Acuity version number as well as One Touch version number.

Power Settings

Some features described herein may not be available for the current scanner.

- **Sleep mode**—sleep mode is the low-power state when the scanner is not in use. You can adjust the amount of time you want the scanner to wait before it goes into low power.
Click the green enter button to save any changes in the Sleep mode field.
Click the red reset button to reset to the default timeout value.
Click the **Sleep** button to immediately put the scanner into low power mode. Click the **Wake** button to bring the scanner out of low power mode.
- **Power off**—input the number of minutes you want the scanner to wait before it turns itself off.
Click the green enter button to save any changes in the power off field.
Click the red reset button to reset to the default timeout value.

Scanner maintenance:

- **Counters**—click the reset button next to the counter you want to set back to 0.
- **Show maintenance reminders**—select this option be notified when it is time to clean or replace the rollers. After cleaning or replacing the rollers, click the reset button next to the roller counters in this screen.

To view the counters from the LCD Scanner Menu:

1. Hold the Simplex and Duplex buttons for more than two seconds to access the LCD scanner menu.
2. Use the up and down arrows to select the Counters option.
3. Use the Duplex button to confirm your selection.
4. You can now view the counters.

Note: You can only view the counters from the LCD Scanner Menu. It is not possible to reset the counters from this menu.

DRIVER SETTINGS

The options in this panel are for configuring how the TWAIN interface will behave in some scenarios. Please see the TWAIN scanning guide for instructions.

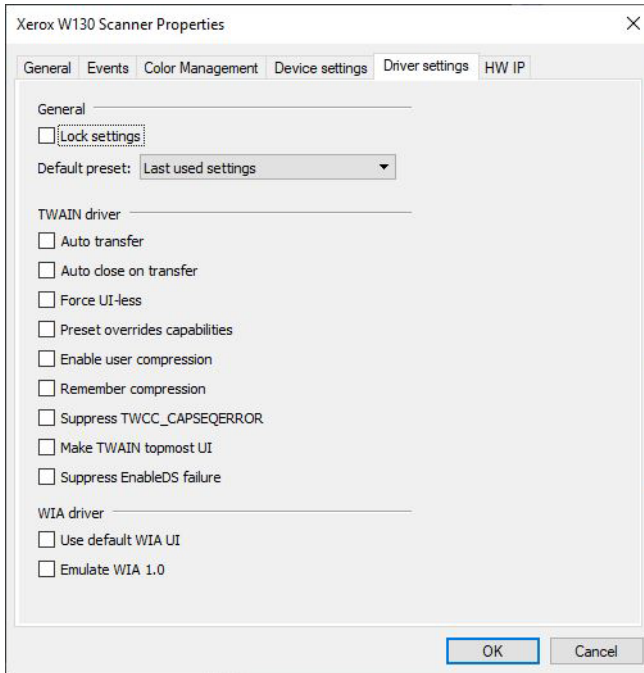

Clearing Paper Jams

If your scanner stops scanning due to a paper jam in the Automatic Document Feeder, use the following procedure to remove the paper from the scanner.

1. Pull on the scanner cover release and lift the lid to open the scanner.
Do not attempt to remove a jammed page with the ADF door closed.

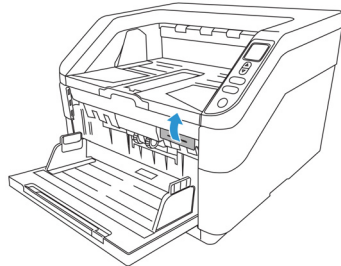

2. Remove the jammed page from the scanner.
3. Close the ADF door and continue scanning.

To reduce the number of paper jams, smooth and straighten the paper before scanning and adjust the paper guides to the paper size.

Cleaning the Scanner

Regular maintenance of your scanner can help to ensure continual optimal performance.

Using a soft, lint-free cloth, wipe down all plastic surfaces on the scanner.

CLEANING THE OUTSIDE OF THE SCANNER

Excessive dust accumulation around and on the scanner will pull into the scanner during the scanning process and clog the ventilation openings. You should clean the outside of the scanner at least once a month to help limit the amount of dust build up in the scanner.

1. Turn off the scanner power.
2. Using a soft dusting cloth, wipe down the body of the scanner, input tray and exit area. Make sure that the input and exit slots in the scanner are also clean.
3. If there is any accumulation of dust in the indentations around the buttons, use a blower brush to gently brush away the dust.
4. When you're finished, press the power button to turn the scanner back on.

CLEANING THE INSIDE OF THE SCANNER

Cleaning the inside of the scanner helps to keep your scanner operating at optimum performance. You should clean the inside of the scanner at least once a week or after 20,000 pages have been scanned. If you are getting frequent paper jams, multiple pages feeding at the same time, or you're seeing lines in the scanned image, it is time to clean the scanner.

Note: When cleaning the rollers, do not rub the roller cleaning paper vigorously back and forth across the roller, this will shred the roller cleaning paper and leave debris in the scanner.

Safety Precautions

- Keep the roller cleaning paper away from fire, heaters or any open flame or heat source as any form of alcohol is flammable.
- Wear protective gloves as the roller cleaning paper may irritate sensitive skin.
- Only clean the rollers and scanning areas, as described in this section, with the roller cleaning paper.
- Do not leave the roller cleaning paper or any of the cleaning supplies where children can access them.
- Always turn off the scanner and unplug the scanner's power and USB cable prior to using the roller cleaning paper.

Preparation

- Roller cleaning papers can be purchased from our website at www.xeroxscanners.com in the Supplies & Accessories page for your scanner.
- When cleaning the inside of the scanner, you should clean all of the rollers, scanner glass and background plates at the same time.
- Use scissors to open the roller cleaning paper bag, cutting across the dotted line.

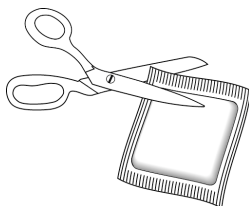

! **Caution: The roller cleaning paper is moistened with isopropyl rubbing alcohol. Please read and follow these precautions to ensure your safety.**

CLEANING THE ADF ROLLERS

When you perform cleaning for the feeding rollers in the lower part of the scanner, the rollers need to be rotated with a light force. Using the Clean Mode, the rollers can be automatically rotated to help cleaning easier and effective.

1. Hold the Simplex and Duplex buttons for more than two seconds to access the LCD scanner menu.
2. Use the up and down arrows to select Clean mode.
3. Use the Duplex button to confirm your selection.
4. Pull on the scanner cover release and lift the lid to open the scanner.

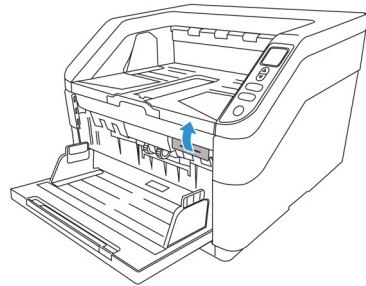

5. Use the Duplex button to initiate roller rotation. Each time you press on the duplex button, the rollers will rotate slightly, allowing you to clean the rollers efficiently.
6. The following illustration shows where the rollers are located in the scanner.

Use a roller cleaning paper, or the wet soft cloth with isopropyl rubbing alcohol (70%), to clean all of the rollers indicated in the illustration.

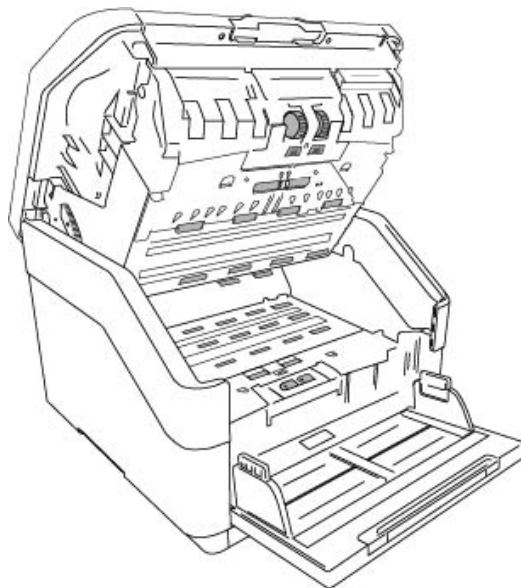

Note: Be careful when cleaning the rollers. All of the rollers, except the free rollers, are designed to rotate in one direction only. Do NOT force the roller to rotate in the opposite direction. Forcing the roller to rotate will damage it, and cause the scanner to feed pages incorrectly.

CLEANING THE SCANNER GLASS AND BACKGROUND PLATES

The background plates are located underneath the scanner glass in both the top and bottom of the scanner. If you see a warning message that one of the background plates is dirty, simply clean the scanner glass as described here.

1. Pull on the scanner cover release and lift the lid to open the scanner.

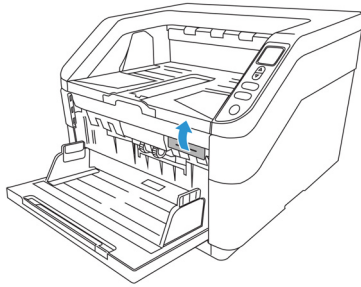

2. The following illustration shows the location of the glass in the scanner.

Use a soft cloth to wipe clean the glass. You can use a roller cleaning paper to clean the glass plates if there is any sticky residue on the surface.

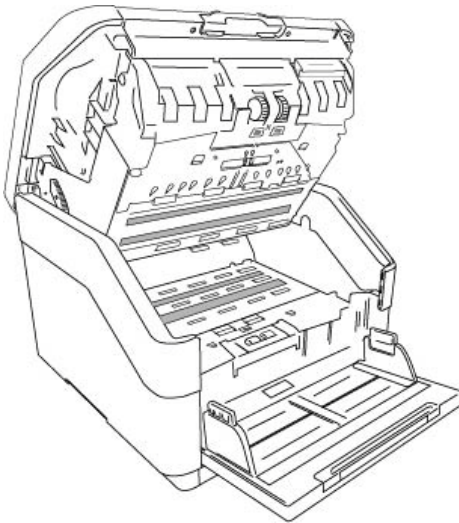

CLEANING THE PAPER SENSORS

The scanner has several sensors to detect the status of the paper when it is in the scanner. You should clean these sensors as part of your standard weekly maintenance of the scanner.

Note: Do not clean the sensors with the roller cleaning paper.

Preparation

- Turn off the scanner prior to cleaning the sensors.

CLEANING THE ADF SENSORS

1. Pull on the scanner cover release and lift the lid to open the scanner.

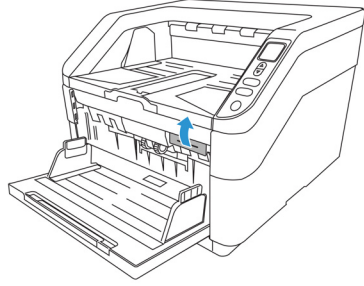

2. The following illustration shows the location of the sensors in the scanner.

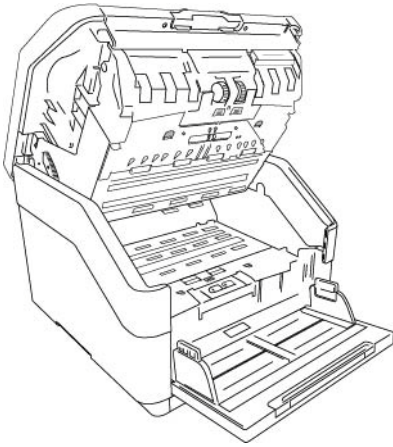

3. Using a clean, dry cotton swab, brush away any dust on the double feed detection sensors.

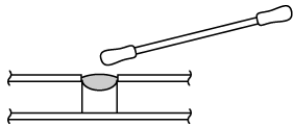

Replacing the Rollers

When replacing the rollers described in this section, you should replace all of the rollers at the same time. Do not replace just one roller and not the other. When you are finished replacing the roller, reset the roller count as described in the page 10-2.

⚠ WARNING: Keep all replaceable parts out of the reach of children. These parts are small and pose a choking hazard.

Turn off the scanner power then unplug the power cord from the scanner. Pull the cover release handle and open the scanner.

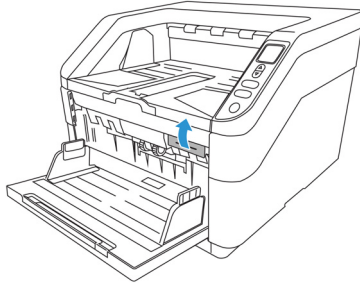

When you are done replacing the rollers, close the scanner carefully pressing down on both sides of the cover until it locks in place. Do not slam down the cover.

REPLACING THE PICK UP ROLLERS

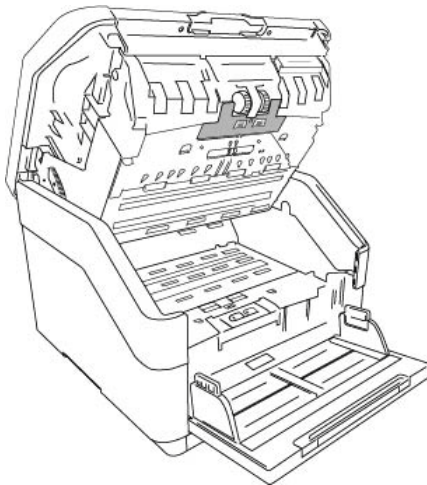

1. Pull down the paper feed roller cover and pull it towards you to access the rollers.

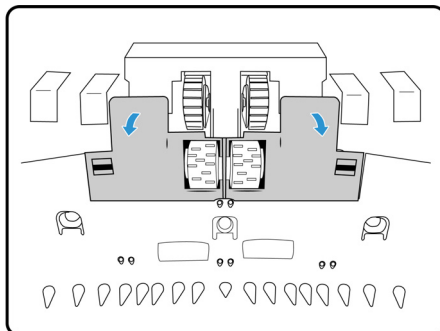

2. Rotate each roller towards you until you see the plastic arm holding it in place.

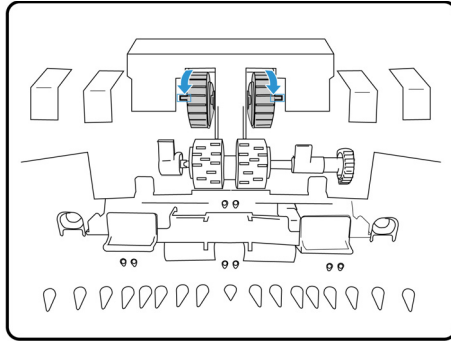

3. Pinch the plastic tab that locks the roller to the metal bar and pull the roller away from the bar. Do this for each of the rollers.
4. Discard the rollers, they cannot be repaired or reused.
5. Take the new rollers out of their packaging.

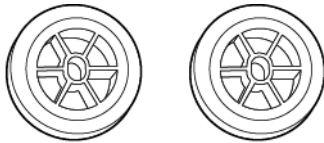

6. Align the end of the bar with the hole in the rollers and slide the rollers onto the bar. The rollers will click when they are locked in place.
7. Lift the roller cover up and carefully push it closed to lock it in place. Make sure everything is aligned properly and the cover is fully closed. If the cover is not fully closed it will break during scanning and damage the scanner

REPLACING THE PAPER FEED ROLLERS

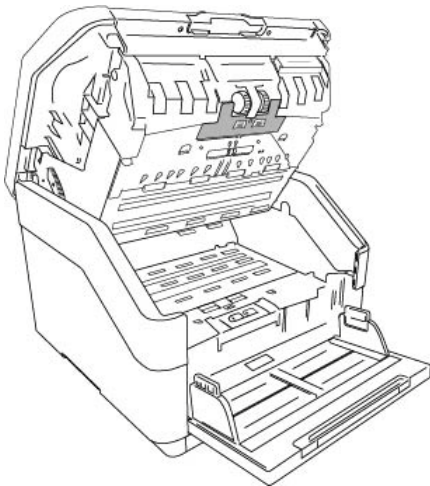

1. Pull down the paper feed roller cover and pull it towards you to access the rollers.

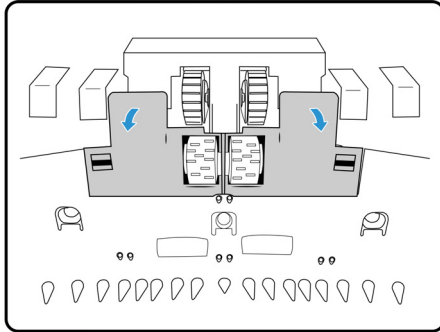

2. Pull down on the plastic arms holding the roller in place.

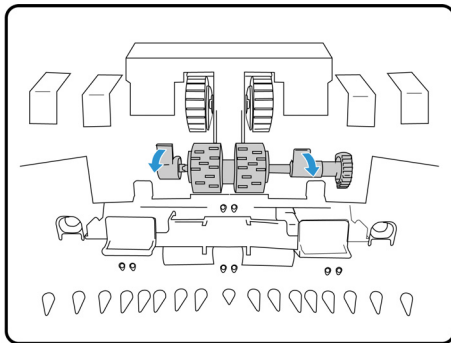

3. Pull out the roller.
4. Discard the rollers, they cannot be repaired or reused.
5. Take the new rollers out of their packaging.

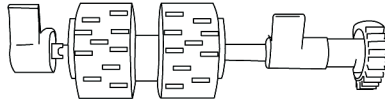

6. Align the end of the bar with the hole in the rollers and slide the rollers onto the bar. The rollers will click when they are locked in place.
7. Lift the roller cover up and carefully push it closed to lock it in place. Make sure everything is aligned properly and the cover is fully closed. If the cover is not fully closed it will break during scanning and damage the scanner.

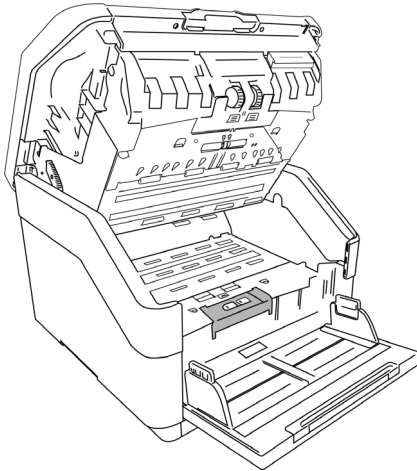
REPLACING THE DOUBLE FEED ROLLER

1. Flip open the double feed prevention roller cover.

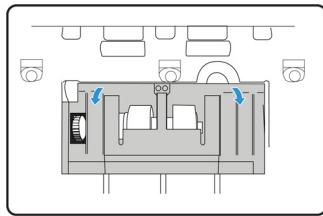

2. Lift the roller up and out of the scanner.

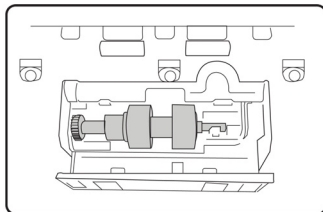

3. Discard the roller, it cannot be repaired or reused.
4. Take the new roller out of its packaging.

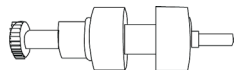







5. Align the roller bar with the brackets in the roller compartment. Make sure the groove on the right side of the roller bar is aligned so that it slides in place into the U shape of the bracket.
6. The roller is properly in place when you cannot rotate the metal bar of the roller.
7. Close the double feed prevention roller cover when you are finished.





SCANNER STATUS MESSAGE TABLE



The LCD displays an error image or code. The following table lists the images, possible causes and common resolutions.

If you are unable to resolve the issue using the troubleshooting steps in this table, please refer to the section “Installing an Ink Cartridge” on page 10-17.

| ERROR IMAGE | CAUSE | RESOLUTION |
|---|--|---|
|  | <p>ADF Paper Jam 1</p> <p>Paper has jammed while being fed through the scanner.</p> <p>Document sensors are dirty.</p> | <p>Open the scanner, remove the pages, then close the scanner. Please see page 10-4 for complete instructions.</p> <p>If problem persists, clean the rollers and paper sensors as described in the section “Cleaning the Inside of the Scanner” on page 10-5.</p> |
|  | <p>ADF Paper Jam 2</p> <p>Paper has jammed while being fed through the scanner.</p> <p>Document sensors are dirty.</p> | <p>Open the scanner, remove the pages, then close the scanner. Please see page 10-4 for complete instructions.</p> <p>If problem persists, clean the rollers and paper sensors as described in the section “Cleaning the Inside of the Scanner” on page 10-5.</p> |
|  | <p>ADF Paper Jam 3</p> <p>Paper has jammed while being fed through the scanner.</p> <p>Document sensors are dirty.</p> | <p>Open the scanner, remove the pages, then close the scanner. Please see page 10-4 for complete instructions.</p> <p>If problem persists, clean the rollers and paper sensors as described in the section “Cleaning the Inside of the Scanner” on page 10-5.</p> |

| ERROR IMAGE | CAUSE | RESOLUTION |
|---|---|---|
|  | <p>Multi-feed</p> <p>Two pages have fed through the scanner at the same time.</p> | <p>When a double feed sheet is inserted in the scanner, the sensors will identify it and act according to user settings. On the scanner LCD menu, three options will appear: Ignore (continue scanning), Continue (re-stack images and continue scanning) or Cancel scan. Use the arrow buttons to select an option and the Duplex button to confirm your selection.</p> <p>If you select Continue, open the scanner, remove the pages, then close the scanner. Make sure there are no pages stuck together.</p> <p>If problem persists, clean the rollers and paper sensors as described in the section “Cleaning the Inside of the Scanner” on page 10-5.</p> |
|  | <p>ADF Cover Open</p> <p>A scanner access cover is open.</p> | <p>Verify all covers on the scanner are fully closed before scanning.</p> |
|  | <p>Download Firmware Error</p> <p>The firmware download has failed.</p> | <p>Download the firmware and try again.</p> |

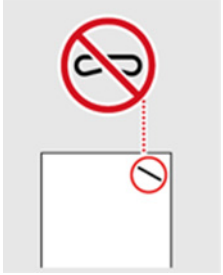
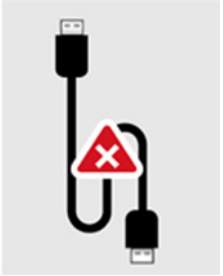
| ERROR IMAGE | CAUSE | RESOLUTION |
|---|--|--|
|  | <p>Misfeed</p> <p>Failed to pick paper.</p> | <p>Remove the paper from input tray. Fan the documents.</p> <p>Load the document with its edges slightly touching the paper guides.</p> <p>Rescan.</p> |
|  | <p>Fan Error 1</p> <p>The fan has stopped working.</p> | <p>Turn off the scanner. Contact Technical Support and send the scanner for repair.</p> |
|  | <p>Fan Error 2</p> <p>The fan has stopped working.</p> | <p>Turn off the scanner. Contact Technical Support and send the scanner for repair.</p> |
|  | <p>Fan Error 3</p> <p>The fan has stopped working.</p> | <p>Turn off the scanner. Contact Technical Support and send the scanner for repair.</p> |

| ERROR IMAGE | CAUSE | RESOLUTION |
|---|---|---|
|  | <p>Stapled Document Detected</p> <p>Either the page bent when it was picked up from the input tray, or the page skewed greatly as it was pulled into the scanner.</p> | <p>Remove the staples from the document.</p> <p>Open the scanner, remove the pages, then close the scanner. Check all documents and remove any staples.</p> <p>Restack the paper in the ADF and click rescan.</p> |
|  | <p>USB Disconnected</p> <p>The USB is disconnected from the scanner or the PC.</p> | <p>Verify that the USB cable is securely plugged into the scanner and computer.</p> |
|  | <p>Tray Not Open</p> <p>Input tray has not been opened.</p> | <p>Open the input tray.</p> |
|  | <p>Tray Lock</p> <p>This error means that the tray is stuck and cannot be moved. It usually happens when the gears and motors need to be repaired.</p> | <p>Turn off the scanner. Contact Technical Support and send the scanner for repair.</p> |

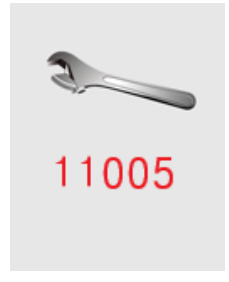
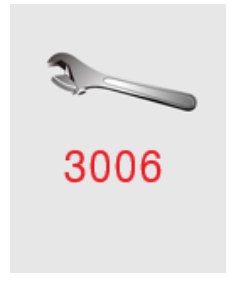
| ERROR IMAGE | CAUSE | RESOLUTION |
|---|--|---|
|  | <p>ADF AFE R/W Test Error</p> <p>Firmware checks whether the hardware AFE is reading and writing normally when booting.</p> <p>If it is running abnormally, the scanner cannot scan.</p> | <p>Turn off the scanner. Contact Technical Support and send the scanner for repair.</p> |
|  | <p>System Input Buffer Over Run</p> <p>This error happens when the ASIC receives too many images at once.</p> | <p>Turn off the scanner. Contact Technical Support and send the scanner for repair.</p> |
|  | <p>ADF Lamp Error</p> <p>The ADF lamp has stopped working.</p> | <p>Turn off the scanner. Contact Technical Support and send the scanner for repair.</p> |

Installing an Ink Cartridge

The information in this guide will cover hardware and software features that may not be available for the scanner model you purchased. Please disregard any information that does not apply to your scanner.

1. Turn off the scanner.
2. Open the imprinter door.
3. Remove the protective tape from the ink cartridge.

4. Move the ink cartridge carriage to the imprinter unit.

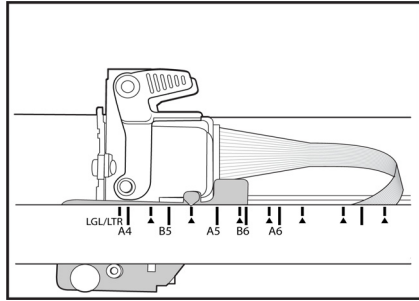

5. Insert the ink cartridge into the carriage as shown in the diagram.

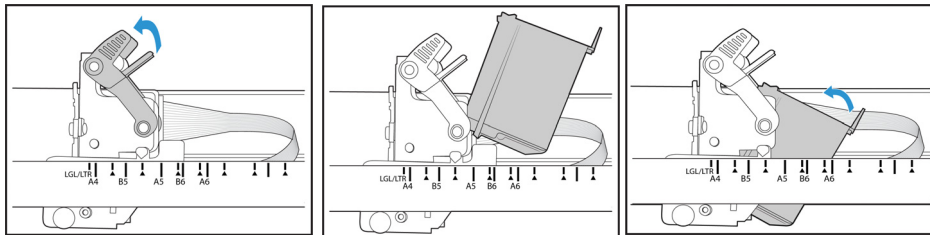

6. Lower the arms on the carriage to lock the ink cartridge in place.

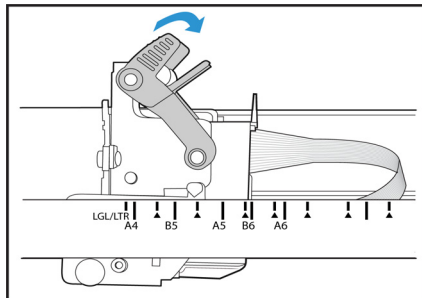

7. Reverse this procedure to remove the ink cartridge when it is time to be replaced.

Adjusting the Printing Position

The information in this guide will cover hardware and software features that may not be available for the scanner model you purchased. Please disregard any information that does not apply to your scanner.

You set the horizontal start position by moving the ink carriage in the imprinter unit itself. Move the ink carriage left or right and align the arrow tab to the appropriate paper width indicated on the imprinter unit. The vertical start position is set in the scanning interface you are using.

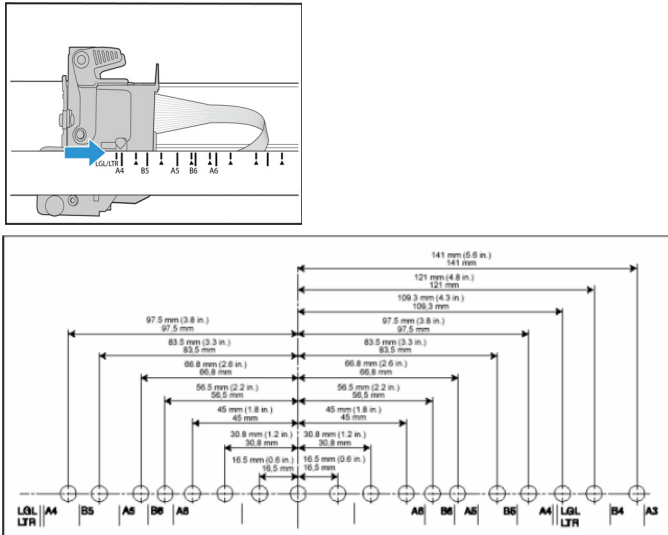

Troubleshooting

Problem: The scanner won't scan. What's wrong?

Check for one of these possible causes:

- **Are the cables loose or not plugged in securely?** Inspect the cable connections. Make sure the cables are plugged in securely.
- **Is the scanner's status light on?** Turn on the scanner's power. If the status light doesn't come on, plug the power supply into another electrical outlet. If you are using a UPS battery back-up or power strip, try plugging the scanner directly to a wall outlet.
- **Did you restart the computer and scanner?** If the scanner gets a paper jam, or loses connection because of an error, try restarting your computer and power cycling the scanner.
- **Did you plug the scanner into a USB hub?** If you're using a USB hub to connect the scanner try plugging the scanner's USB cable directly to the back of the computer. It is not recommended that you use the scanner with a USB hub, if you are using a hub, the hub must have its own power supply.
- **Is the USB cable 6' or less?** If you are using a USB cable that is longer than 6' you may lose connection to the scanner. The recommended USB cable length is 6' or less, the USB cable provided with your scanner is within this range.
- **Did you select another image source in the scanning software?** If you use multiple imaging devices with your computer, such as a camera, all-in-one printer, or another scanner, you may have selected another source for images. Make sure the correct scanner is selected.

Problem: The scanned images are of poor quality. What do I do?

There are various reasons why the scanned image is of poor quality. The original document may not be of good quality or the scanner glass may be dirty.

- Try cleaning the scanner. The scanner glass is where the image is captured as the page is pulled through the scanner. Lift up on the exit release, under the input tray, to open the scanner. There is glass in the body of the scanner and underneath the lid. Take a soft cloth and wipe across both pieces of glass. The section “Cleaning the Scanner Glass and Background Plates” on page 10-7 contains thorough instructions for cleaning this part of the scanner.

Problem: Why does my scanner not function after performing a system restore on Windows?

The system restore process may have corrupted some of the driver components. It is recommended that you reinstall your scanner driver. Please refer to “Uninstalling Your Scanner” on page 10-21 for installation instructions.

Problem: Why won't my scanner buttons work after scanning with Windows Image Acquisition (WIA)?

After performing a scan using the WIA interface you must close the application you were using before scanning with the buttons on the scanner. This does not occur when scanning using the TWAIN interface.

Problem: Why won't my scanner work after the computer has been sitting idle for several hours?

To resolve the problem, simply turn off the scanner power then turn it back on again.

This may occur after Windows goes into power saving mode to “hibernate” the computer into a low power state. When you move your mouse or type on the keyboard it “wakes” the computer back up and restores full power to the system. This power fluctuation during the computer's hibernating period may sometimes cause the scanner to lose communication to the computer.

Problem: The installation will not complete successfully. If installation finishes, the scanner's OneTouch options do not seem to work properly.

A likely cause is that some driver programs are already installed on your computer for another scanner. They may be interfering with the installation and OneTouch options, and you need to remove those other drivers and re-install your Xerox® scanner. You can remove these programs from the Windows Control Panel. Please refer to the user manual provided with your other scanner hardware for instructions about removing the driver and software for that unit.

Problem: My computer keeps giving me out of hard drive space error messages.

The minimum requirement of free hard drive space is for the installation of the scanner driver and basic, low resolution, scanning. High resolution scans result in files that can be over 1 gigabyte in size. Free up some space on your hard drive for the software to be able to save the scanned images.

Problem: The paper jams the ADF.

To reduce the number of paper jams, smooth and straighten the paper before scanning, and adjust the guides to the paper size. Paper fed into the ADF at an angle can cause the feed mechanism to jam. If paper jams are occurring more frequently, try cleaning the roller with a soft cloth dampened with isopropyl rubbing alcohol. Excessive dust on the roller can make it appear worn and will cause issues feeding paper. See “Cleaning the Inside of the Scanner” on page 10-5 for cleaning instructions.

Problem: The ADF won't feed pages properly.

A dirty or worn roller can cause documents to feed in skewed at an angle, or multiple pages to feed at the same time. First, try cleaning the rollers as described in “Cleaning the Inside of the Scanner” on page 10-5. If the problem persists, the separation and/or feed rollers may need to be replaced. Please see “Replacing the Rollers” on page 10-8.

Problem: If the USB cable is disconnected during a scan, the scanner does not reconnect when the USB cable is plugged back in.

Unplug the power cable from the scanner, and then plug it back in.

If the scanner does not reconnect:

1. Unplug the power cable from the scanner.
2. Restart your computer.
3. After the restart is complete, plug the power cable back in.

Problem: The scanner reports a Double Feed error when there is only one page in the scanner.

Try cleaning the double feed detection sensor. Dust on the sensor may prevent the sensor from working properly.

Uninstalling Your Scanner

Use the options in the Windows Control Panel to remove the scanner driver and modules, and any other software provided with the scanner.

Please leave the scanner's USB cable plugged into the computer while uninstalling the scanner driver. Unplug the USB cable when directed to do so in the instructions below.

Open the list of installed programs in the Windows Control panel.

- Windows 7 and later: Open Programs and Features

Uninstalling the scanner driver:

1. In the list of installed programs click Xerox® W130 / W110 Scanner driver.
2. Click the **Change** or **Uninstall** button.
3. Click **Yes** when asked to confirm that you want to remove the driver.

When the driver uninstallation is complete the progress window will automatically close.

4. Turn off the scanner and unplug the USB cable.

5. Reboot the computer if you are prompted to do so.

Follow these instructions to remove any of the other software you installed with your scanner. Depending on the software provided with your scanner, and which applications you installed during the scanner setup, the application list may include:

- OneTouch
- OneTouch OCR module
- Visioneer Organizer AI
- Visioneer Capture SE

Uninstalling Visioneer Acuity™:

Visioneer Acuity is automatically installed when you install the scanner driver. You can also download the Visioneer Acuity module from the support pages for your scanner at www.xeroxscanners.com. Visioneer Acuity is a utility with advanced image processing options to instantly improve the visual clarity of anything you scan.

1. In the list of installed programs select **Visioneer Acuity Assets**.
2. Click **Yes** when asked to confirm you want to remove the software.

Depending on the method of installation, and your scanner model, there may be multiple entries for Visioneer Acuity in the installed programs list. The additional entries in this list are the image processing libraries needed to support various scanner models. These additional items will be called “Visioneer Acuity Assets” followed by a version number. In the scenario described here, when you want to uninstall Visioneer Acuity make sure you select and uninstall Visioneer Acuity. If you uninstall one of the entries labeled as an “asset” you will still need to uninstall the main Visioneer Acuity utility.



Xerox® W130 / W110 Scanner Specifications

| Scanner Specifications | |
|--|---|
| Document Requirements | |
| Minimum Item Size | Single Page 1.97 x 2.56 inches (50 x 65 mm) Multi Page 1.97 x 3.35 inches (50 x 85 mm) |
| Maximum Item Size | 12.1 x 17.0 inches (308 x 432 mm) |
| Capacity | 500 pages of 20lb printer paper (80 g/m ²) |
| Paper Thickness | U-Turn Path: 27~105 g/m ² (7 ~ 28 lbs) Straight path: 27~ 413 g/m ² (7 ~ 110lbs) |
| General Specifications | |
| Optical Resolution | 600 dpi |
| Interpolated Resolutions (Firmware/Hardware) | 100, 150, 200, 300, 400, 500 dpi |
| Interpolated Resolutions (Visioneer Acuity) | 75 and 1200 dpi (these resolutions are available when Visioneer Acuity is installed) |
| Output Bit Depth | 24-bit color, 8-bit grayscale, 1-bit bitonal (black & white) |
| Scan Method | Duplex Automatic Document Feeder (ADF) |

| Scanner Specifications | |
|--------------------------------------|---|
| Image Sensor | CIS (Contact Image Sensor) |
| Light Source | RGB LED |
| Interface | USB 3.1 (USB 2.0 and 1.1 compatible) |
| Certifications | ENERGY STAR 3, USB 3.1, RoHS, CE, CB, WEEE, UL, C-UL, FCC Class A, EPEAT (Bronze Minimum) |
| Operating Temperature | 41° to 95° F (5° C ~ 35° C) |
| Relative Humidity | 10% ~ 90% RPH |
| Scanner Dimensions (Trays Collapsed) | |
| Width | 18.1 inches (460 mm) |
| Depth | 30.5 inches (775 mm) |
| Height | 14.3 inches (362 mm) |
| Weight | 50 lbs (22.7 kg) |
| Power Information | |
| Power Supply | 100~240Vac |
| Power consumption | ≤ 120 Watts (during operation) ≤ 25 Watts (ready) ≤ 2.9 Watts (power save after 15 minutes without scanning, can be adjusted by software) ≤ 0.3 Watt (power off) |
| Cable Information | |
| AC Power Cord | US—3P, 10A/125V, L=1800mm, 3X18AWG, BLACK, RoHS EUR(CEE)—2P+G, 16A/250V, 3*0.75mm ² , L=1800mm, BLACK, RoHS UK(BS/PSB)—3P, 3A/250V, 3C*0.75mm ² , L=1800mm, BLACK, RoHS |
| USB cable | 3.1, 1800 mm, RoHS Compliant |
| Software Information | |
| Supported Operating Systems | Microsoft Windows – 32-bit or 64-bit, 10 – 32-bit or 64-bit 7 (Service Pack 1) – 32-bit or 64-bit 8 / 8.1 |
| Scanner Drivers | TWAIN, WIA, ISIS |
| Bundled Software | Visioneer OneTouch® Visioneer Acuity Module Visioneer Organizer AI Visioneer Capture SE |

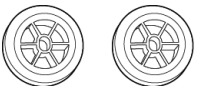
Xerox® W130 / W110 Scanner Parts List

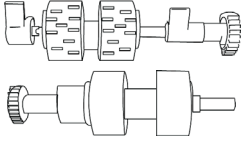
| PART NAME | PART NUMBER | |
|-----------------|-------------|--|
| Pick Up Rollers | 65-2613-000 |  |

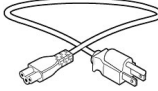
| PART NAME | PART NUMBER | |
|--|---|--|
| Cleaning and Maintenance Kit <ul style="list-style-type: none">• Feed Roller• Separation Roller | 96-X331-000 65-2612-000 65-2614-000 |  |
| USB Cable | 35-0253-001 |  |
| AC Power Cord | 35-0103-001 (US) 35-0104-001 (EUR) 35-0105-001 (UK) |  |

11. Appendix A: Regulatory Information

Basic Regulations

UNITED STATES (FCC REGULATIONS)



This equipment has been tested and found to comply with the limits for a Class A digital device, pursuant to Part 15 of the FCC Rules. These limits are designed to provide reasonable protection against harmful interference when the equipment is operated in a commercial environment. This equipment generates, uses, and can radiate radio frequency energy and, if not installed and used in accordance with the instruction manual, may cause harmful interference to radio communications.

Operation of this equipment in a residential area is likely to cause harmful interference in which case the user will be required to correct the interference at his own expense.



WARNING:

In order to allow this equipment to operate in close proximity to Industrial, Scientific and Medical (ISM) equipment, the external radiation from ISM equipment may have to be limited or special mitigation measures taken.

Changes and modifications to this equipment not specifically approved by Xerox® may void the user's authority to operate this equipment.

Shielded cables must be used with this equipment to maintain compliance with FCC regulations.

EUROPEAN UNION

The CE mark applied to this product, symbolizes our declaration of conformity with the following applicable European Union Directives, as of the dates indicated:



| | |
|--------------------|---|
| September 8, 2017: | Council Directive 2014/35/EU as amended. Approximation of the laws of the member states related to low voltage equipment. |
| August 12, 2016: | Council Directive 2014/30/EU as amended. Approximation of the laws of the member states related to electromagnetic compatibility. |

This machine is certified as Class 1 LED product. This means that this machine does not produce hazardous laser radiation.

A full declaration of conformity, defining the relevant directives and referenced standards, can be obtained from your Xerox Limited representative or by contacting:

Environment, Health and Safety
Xerox(NL)
Sint Jansweg 15
NL-5928 RC

VENLO

TURKEY (ROHS REGULATION)

In compliance with Article 7 (d) We hereby certify “It is in compliance with the EEE Regulation”.

(“EEE yönetmeliğine uygundur“)

Copy Regulations

UNITED STATES

Congress, by statute, has forbidden the reproduction of the following subjects under certain circumstances. Penalties of fine or imprisonment may be imposed on those guilty of making such reproductions.

1. Obligations or Securities of the United States Government, such as:

| | | |
|------------------------------|-------------------------|-----------------------|
| Certificates of Indebtedness | National Bank Currency | Coupons from Bonds |
| Federal Reserve Bank Notes | Silver Certificates | Gold Certificates |
| United States Bonds | Treasury Notes | Federal Reserve Notes |
| Fractional Notes | Certificates of Deposit | Paper Money |

Bonds and Obligations of certain agencies of the government, such as FHA, etc.

Bonds. (U.S. Savings Bonds may be photographed only for publicity purposes in connection with the campaign for the sale of such bonds.)

Internal Revenue Stamps. (If it is necessary to reproduce a legal document on which there is a canceled revenue stamp, this may be done provided the reproduction of the document is performed for lawful purposes.)

Postage Stamps, canceled or uncanceled. (For philatelic purposes, Postage Stamps may be photographed, provided the reproduction is in black and white and is less than 75% or more than 150% of the linear dimensions of the original.)

Postal Money Orders.

Bills, Checks, or Drafts of money drawn by or upon authorized officers of the United States.

Stamps and other representatives of value, of whatever denomination, which have been or may be issued under any Act of Congress.

2. Adjusted Compensation Certificates for Veterans of the World Wars.
3. Obligations or Securities of any Foreign Government, Bank, or Corporation.
4. Copyrighted material, unless permission of the copyright owner has been obtained or the reproduction falls within the “fair use” or library reproduction rights provisions of the copyright law. Further information of these provisions may be obtained from the Copyright Office, Library of Congress, Washington, D.C. 20559. Ask for Circular R21.
5. Certificates of Citizenship or Naturalization. (Foreign Naturalization Certificates may be photographed.)
6. Passports. (Foreign Passports may be photographed.)
7. Immigration Papers.
8. Draft Registration Cards.

9. Selective Service Induction Papers that bear any of the following Registrant's information:

| | | |
|---------------------------|------------------------------|--------------|
| Earnings or Income | Dependency Status | Court Record |
| Previous military service | Physical or mental condition | |

Exception: U. S. Army and Navy discharge certificates may be photographed.

10. Badges, Identification Cards, Passes, or Insignia carried by military personnel, or by members of the various Federal Departments, such as FBI, Treasury, etc. (unless photograph is ordered by the head of such department or bureau.)
11. Reproducing the following is also prohibited in certain states: Automobile Licenses — Drivers' Licenses — Automobile Certificates of Title.

The above list is not all inclusive, and no liability is assumed for its completeness or accuracy. In case of doubt, consult your attorney.

CANADA

Parliament, by statute, has forbidden the reproduction of the following subjects under certain circumstances. Penalties of fines or imprisonment may be imposed on those guilty of making such copies.

1. Current bank notes or current paper money.
2. Obligations or securities of a government or bank.
3. Exchequer bill paper or revenue paper.
4. The public seal of Canada or of a province, or the seal of a public body or authority in Canada, or of a court of law.
5. Proclamations, orders, regulations or appointments, or notices thereof (with intent to falsely cause same to purport to have been printed by the Queen's Printer for Canada, or the equivalent printer for a province).
6. Marks, brands, seals, wrappers or designs used by or on behalf of the Government of Canada or of a province, the government of a state other than Canada or a department, board, Commission or agency established by the Government of Canada or of a province or of a government of a state other than Canada.
7. Impressed or adhesive stamps used for the purpose of revenue by the Government of Canada or of a province or by the government of a state other than Canada.
8. Documents, registers or records kept by public officials charged with the duty of making or issuing certified copies thereof, where the reproduction falsely purports to be a certified copy thereof.
9. Copyrighted material or trademarks of any manner or kind without the consent of the copyright or trademark owner.

The above list is provided for your convenience and assistance, but it is not all inclusive, and no liability is assumed for its completeness or accuracy. In case of doubt, consult your solicitor.

OTHER COUNTRIES

Copying certain documents may be illegal in your country. Penalties of fine or imprisonment may be imposed on those found guilty of making such reproductions.

- Currency notes
- Bank notes and cheques
- Bank and government bonds and securities
- Passports and identification cards
- Copyright material or trademarks without the consent of the owner
- Postage stamps and other negotiable instruments

Note: This list is not inclusive and no liability is assumed for either its completeness or accuracy. In case of doubt, contact your legal counsel.

12. Appendix B: Compliance Information

Product Recycling & Disposal

USA & CANADA

If you are managing the disposal of your Xerox® product, please note that the product may contain lead, mercury, perchlorate, and other materials whose disposal may be regulated due to environmental considerations. The presence of these materials is fully consistent with global regulations applicable at the time that the product was placed on the market. For recycling and disposal information, contact your local authorities. In the United States, you may also refer to the Electronic Industries Alliance web site.

Perchlorate Material - This product may contain one or more Perchlorate-containing devices, such as batteries. Special handling may apply.

EUROPEAN UNION

RoHS Compliance

This product is compliant with RoHS Regulations of the European Parliament and Council Directive on the Restrictions of the Use of Certain Hazardous Substances in Electrical and Electronic Equipment (2011/65/EU).

Some equipment may be used in both a domestic/household and a professional/business application.

ENERGY STAR for the USA

Energy Program Compliance

The Xerox® W130 / W110 Scanner is ENERGY STAR qualified under the ENERGY STAR Program Requirements for Imaging Equipment.



The ENERGY STAR and ENERGY STAR MARK are registered United States trademarks. The ENERGY STAR Imaging Equipment Program is a team effort between U.S., European Union and Japanese governments and the office equipment industry to promote energy-efficient copiers, printers, fax, multifunction machine, personal computers, and monitors. Reducing product energy consumption helps combat smog, acid rain and long-term changes to the climate by decreasing the emissions that result from generating electricity.

Xerox® equipment is preset at the factory. Your machine will be delivered with the timer for switching to Power Save Mode from the last scan set at 15 minutes.

