

**plustek**

# Scanner User's Guide

## SmartOffice

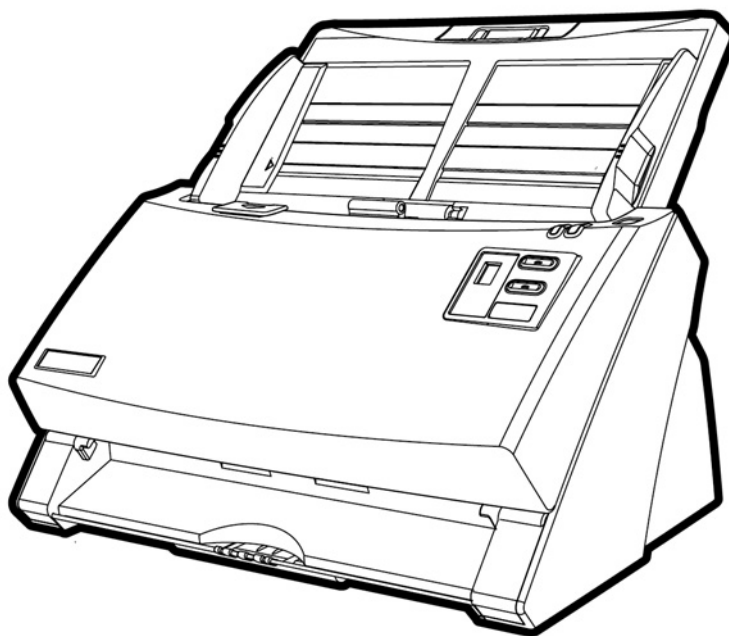

## **Trademarks**

© 2021 Plustek Inc. All rights are reserved. No portion of this document may be reproduced without permission.

Plustek is a registered trademark of Plustek Inc. OCR processing by ABBYY® FineReader®, © 2021 ABBYY. ABBYY and FineReader are trademarks of ABBYY Software, Ltd. which may be registered in some jurisdictions.

All trademarks and brand names mentioned in this publication are property of their respective owners.

## **Liability**

While all efforts have been made to ensure the accuracy of all contents in this manual, we assume no liability for errors or omissions or by statements of any kind in this manual, whether such errors are omissions or statements resulting from negligence, accidents, or any other cause. The contents of this manual are subject to change without notice. We will not shoulder any legal liability, if users failed to follow the operation instructions in this manual.

## **Copyright**

The scanning of certain documents, for example checks, bank notes, I.D. cards, government bonds, or public documents, may be prohibited by law and/or subject to criminal prosecution. We recommend you to be responsible and respectful of the copyrights laws when you are scanning books, magazines, journals and other materials.

## **Environmental Information**

Recycle or disposal at end-of-life information, please ask local distributors or suppliers for recycle and disposal information. The product is designed and produced to achieve sustainable environmental improvement. We strive to produce products in compliance with global environmental standards. Please consult your local authorities for proper disposal.

The product packaging is recyclable.

Attention for recycling (For EU country only)

Protect your environment! This product should not be thrown into the household waste container. Please give it to the free collecting center in your community.

## **Screen Examples in This Manual**

The screen shots in this guide were made with Windows 7. If you are using Windows XP / Vista / 8 / 10, your screen will look somewhat different but functions the same.

# Table of Contents

|  |           |
|--|-----------|
| <b>INTRODUCTION</b> .....  | <b>1</b>  |
| How to Use This Guide.....   | 1         |
| Conventions of This Guide.....   | 2         |
| <i>A Note about Icons</i> .....  | 2         |
| Safety Precautions.....  | 2         |
| Minimum System Requirements.....   | 3         |
| Box Contents.....  | 4         |
| Scanner Overview.....  | 5         |
| LED Indicator.....   | 8         |
| Ultrasonic Sensor.....   | 9         |
| <b>CHAPTER I. INSTALLING THE SCANNER</b> .....                               | <b>10</b> |
| Software Installation Requirements.....                                      | 10        |
| Hardware Requirements.....   | 10        |
| Installing and Setting up the Scanner.....                                   | 11        |
| <i>Step 1. Install the Paper Chute</i> .....                                 | 11        |
| <i>Step 2. Connecting the Scanner to Your Computer</i> .....                 | 12        |
| <i>Step 3. Installing the Software</i> .....                                 | 14        |
| <i>Step 4. Testing the Scanner</i> .....                                     | 16        |
| Installing Additional Software.....  | 17        |
| <b>CHAPTER II. SCANNING</b> .....  | <b>18</b> |
| Preparing Documents.....   | 18        |
| <i>Checking Document Conditions</i> .....                                    | 19        |
| <i>Loosening Documents</i> .....   | 21        |
| Placing Documents.....   | 22        |
| Placing Business Cards.....  | 24        |
| Placing Plastic Cards.....   | 25        |
| Installing the Mix-Paper Scan Frame.....                                     | 26        |
| Scanning Documents.....  | 27        |
| <i>Scanning via TWAIN Interface</i> .....                                    | 27        |
| <i>Scanning from the Scanner's Front Panel</i> .....                         | 29        |
| <i>Scanning from the On-screen DocAction's Execute Menu</i> .....            | 34        |
| <i>Scanning from the Icon in the Left Side of the DocAction Window</i> ..... | 35        |
| <b>CHAPTER III. CARE AND MAINTENANCE</b> .....                               | <b>37</b> |
| Cleaning the Scanner.....  | 37        |
| <i>Cleaning Materials</i> .....  | 37        |
| <i>Cleaning the ADF</i> .....  | 38        |
| Replacing Consumables.....   | 40        |
| <i>Replacing the Friction Roller Module</i> .....                            | 40        |
| <i>Replacing the Feed Roller</i> .....                                       | 41        |
| Calibrating the Scanner.....   | 44        |
| Power Save.....  | 45        |
| <b>CHAPTER IV. TROUBLESHOOTING</b> .....                                     | <b>47</b> |
| Scanner Connection.....  | 47        |
| Clearing Paper Jams.....   | 48        |
| <b>APPENDIX A: SPECIFICATIONS</b> .....                                      | <b>49</b> |
| <b>APPENDIX B: CUSTOMER SERVICE AND WARRANTY</b> .....                       | <b>50</b> |

|                                     |    |
|-------------------------------------|----|
| Service & Support Information ..... | 50 |
| Statement of Limited Warranty ..... | 51 |
| FCC Radio Frequency Statement.....  | 52 |

# INTRODUCTION

Thank you for choosing us as your scanner supplier. Your new scanner will improve the professionalism of your day-to-day computing tasks by allowing you to input images and electronic text into your computer system. You can easily scan single-sided or double-sided documents with your scanner.

Like all of our products, your new scanner is thoroughly tested and backed by our reputation for unsurpassed dependability and customer satisfaction. We hope you will continue to turn to us for additional quality products as your computing needs and interests grow.

## HOW TO USE THIS GUIDE

This User's Guide provides instructions and illustrations on how to install and operate your scanner. This guide assumes the user is familiar with Microsoft Windows. If this is not the case, we suggest you learn more about Microsoft Windows by referring to your Microsoft Windows manual before using your scanner.

The Introduction section of this manual describes the box contents and minimum computer requirements to use this scanner. Before you start installing your scanner, check the box contents to make sure all parts are included. If any items are damaged or missing, please contact the vendor where you purchased your scanner or our customer service directly.

Chapter I describes how to install scanner's software and connect the scanner to your computer. Note: The scanner connects to your computer through the Universal Serial Bus (USB). If your computer does not support USB technology, you will need to purchase a USB interface card to add USB capabilities to your computer, or buy and install USB connectors if your motherboard has USB capabilities. This guide assumes that your computer is USB-ready and has a free USB port.

Chapter II describes how to use your scanner.

Chapter III describes how to maintain and clean your scanner.

Chapter IV contains technical support information that can help you solve simple problems.

Appendix A contains the specifications of the scanner you purchased.

Appendix B contains our customer service, the limited warranty agreement and FCC statement concerning the product.

## CONVENTIONS OF THIS GUIDE

**Bold** —Represents commands or contents on your computer screen.

ALL CAPS —Important note or first use of an important term in a chapter.

*Italic* —Represents buttons on your scanner OR important notes.

### A Note about Icons

This guide uses the following icons to point out information that deserves special attention.



**Warning**



**Attention**



**Information**

A procedure that must be followed carefully to prevent injury, or accidents.

Instructions that are important to remember and may prevent mistakes.

Optional tips for your reference.

## SAFETY PRECAUTIONS



**Warning**

Before using this device, please read the following important information to eliminate or reduce any possibility of causing damage and personal injury.

1. Usage, the product is for indoor use in dry locations. Moisture condensation may occur inside this device and cause malfunction at these conditions:
  - when this device is moved directly from a cold to a warm location;
  - after a cold room is heated;
  - when this device is placed in a damp room.To avoid the moisture condensation, you are recommended to follow the procedure:
  - i. Seal this device in a plastic bag for it to adapt to room conditions.
  - ii. Wait for 1-2 hours before removing this device from the bag.
2. Do use the AC adapter and USB cable provided with the scanner. Use of other AC adapter and cables may lead to malfunction.
3. Keep the space around the AC adapter clear in case you need to quickly unplug the AC adapter during emergencies.

4. Damaged wire could cause fire or electrical shock. Keep the power cord straight and without being twisted, bended, or scraped.
5. Unplug this device if you don't need to use for a certain period of time, such as, during night or long weekend, to avoid any risks of causing fire.
6. Do not attempt to disassemble the scanner. There is danger of an electrical shock and opening your scanner will void your warranty.
7. Be sure not to bump or knock the scanner glass as it is fragile and could break.
8. Do not subject the scanner to excessive vibration. It may damage the internal components.

## **MINIMUM SYSTEM REQUIREMENTS<sup>1</sup>**

- PC with Intel Pentium® IV 2.4 GHz processor or compatible
- 1 GB RAM
- Available USB 2.0 port
- DVD-ROM Drive
- 2 GB Free Hard Disk Space
- Video card that supports 16-bit color or greater
- Operating System: Windows XP / Vista / 7 / 8 / 10



**Information**

Systems with 2 GB RAM and 3 GB free hard disk space are recommended for optimal performance.

---

<sup>1</sup> Higher requirements may be needed when scanning or editing large quantities of images. The system requirements stated are only a guideline, generally the better the computer (motherboard, processor, hard disk, RAM, video graphic card), the better the results.



## BOX CONTENTS<sup>2</sup>

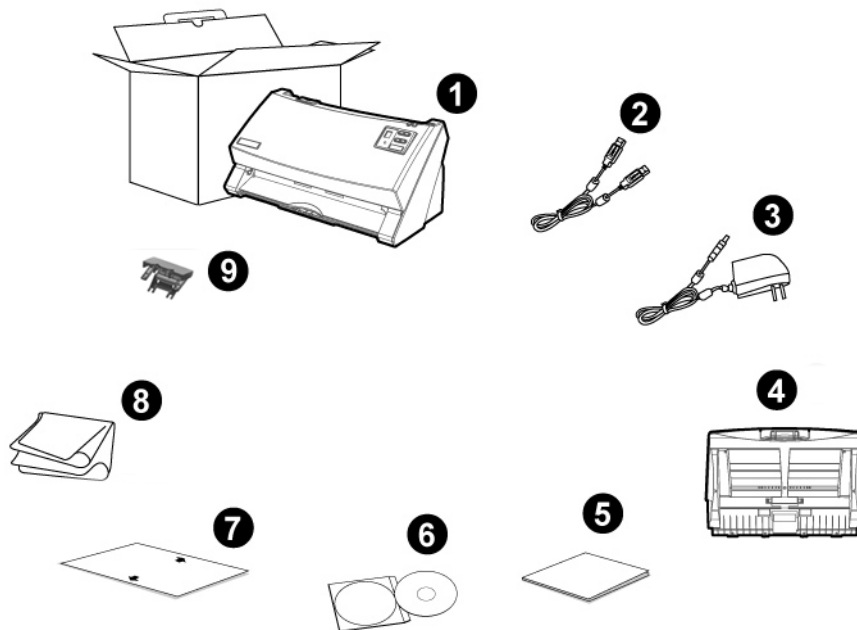

1. Scanner
2. USB Cable
3. AC Adapter
4. Paper Chute
5. Quick Guide
6. Setup/Application DVD-ROM
7. Calibration Sheet
8. Cleansing Cloth
9. Mix-Paper Scan Frame<sup>3</sup> (Option)

<sup>2</sup> Save the box and packing materials in case you need to transport this scanner in the future.

<sup>3</sup> The mix-paper scan frame is not included in all scanner models.

## SCANNER OVERVIEW<sup>4</sup>

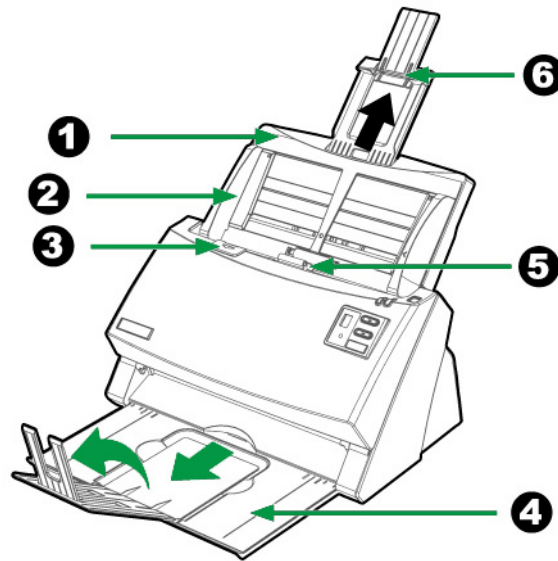

1. PAPER CHUTE—Helps keep the paper in place. Install the paper chute before using the scanner.
2. PAPER WIDTH SLIDER—Adjusts the paper width slider for the paper size you are using.
3. COVER OPEN LEVER—Opens the ADF cover. Pull it to open the ADF cover when you need to clear paper jam or clean the scanner.
4. STACKER—Keeps the paper in place. Extend it in case of longer paper.
5. ADF (AUTOMATIC DOCUMENT FEEDER)—Automatically feeds a stack of documents for scanning.
6. PAPER CHUTE EXTENSION—Extends to hold longer paper.

---

<sup>4</sup> The scanner illustration(s) in this manual may appear different than from the actual scanner itself.

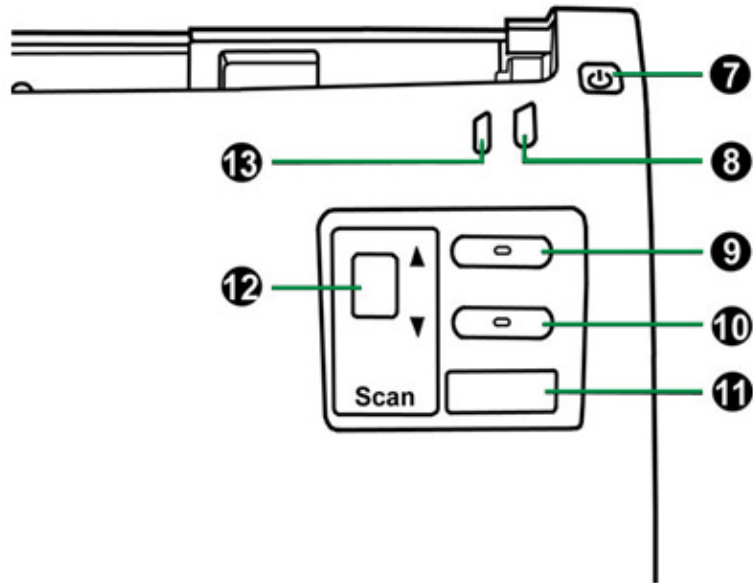

- 7. POWER SAVING BUTTON—Press about 0.5 second to enter the standby mode and you may press this button again to wake up the scanner from power saving.
- 8. POWER / POWER SAVING LED—Indicates the scanner status.
- 9. UP BUTTON—Press to move forward the scanning task number indicated in the function number display.
- 10. DOWN BUTTON—Press to move backward the scanning task number indicated in the function number display.
- 11. SCAN BUTTON—Press to perform a predefined scanning task selected by the up or down button.
- 12. FUNCTION NUMBER DISPLAY—Indicates the number of the predefined scanning task selected by the up or down button.
- 13. WARNING LED—Indicates the scanner error status.

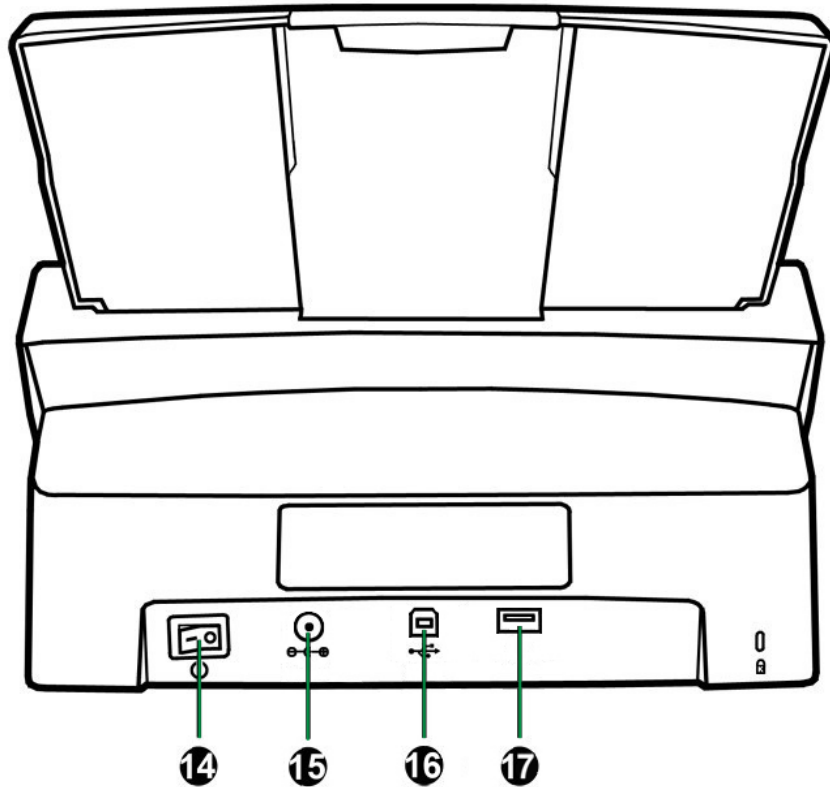

- 14. POWER SWITCH—Use this to turn the scanner ON or OFF.
- 15. POWER RECEPTOR—Connects the scanner to a standard AC power outlet by the included AC adapter.
- 16. USB PORT—Connects the scanner to a USB port on your computer by the included USB cable.
- 17. USB HUB<sup>5</sup>—Connects the scanner to a USB port on another USB scanner by the USB cable.

---

<sup>5</sup> This function may or may not be available depending on the scanner model you purchase.

## LED INDICATOR

The Power/Power Saving LED and Warning LED indicate different scanner status.

| Indicator       | Warning LED Light | Power / Power Saving LED Light | Function Number Display | Status  |
|-----------------|-------------------|--------------------------------|-------------------------|---|
| Power On        | Off               | White                          | On                      | The scanner is turned on, ready to scan images.   |
| Power Off       | Off               | Off                            | Off                     | The scanner is off, either because the power is not turned on, or because the AC adapter is not properly plugged into an AC power outlet.   |
| Cover Open      | Red               | Blinking White                 | On                      | The ADF cover is opened.  |
| Cover Close     | Off               | White                          | On                      | The ADF cover is closed.  |
| Power Save      | Off               | Orange                         | Off                     | The scanner is in standby mode. Simply press any scanner button on the scanner panel and the scanner will return back to the normal status. |
| Operation Error | Blinking Red      | White                          | On                      | ADF missing feed.   |
|                 |                   |                                | On                      | ADF paper jam.  |
|                 |                   |                                | On                      | ADF multi-feed. *Ultrasonic paper-feeding detection function is enabled.  |

## ULTRASONIC SENSOR

When scanning a stack of documents by ADF, the ultrasonic sensor detects multifeeds by checking paper overlap (i.e., 2 or more pages stuck together when being fed through the ADF). Clean the ultrasonic sensor lightly with a dry cloth if it is necessary.



### Information

This function may or may not be available depending on the scanner model you purchase.

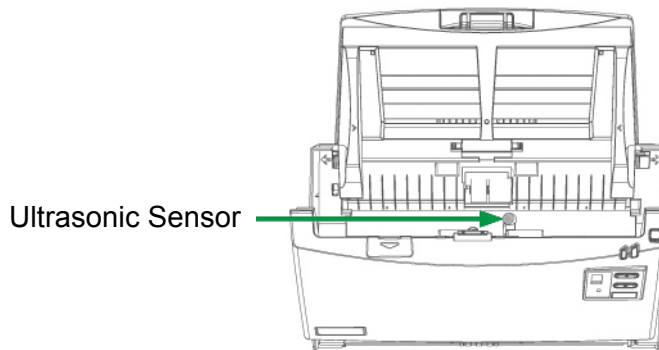

# CHAPTER I. INSTALLING THE SCANNER

Before installing your scanner, please verify that you have all of the proper components. A list of the package contents is provided in the “Box Contents” section of this guide.

## SOFTWARE INSTALLATION REQUIREMENTS

Your scanner comes with the scanner’s driver and DocAction. All of these software applications use approximately 400 megabytes of hard disk space after they are installed into your computer. To ensure ample room for the installation, as well as for scanning and saving images, a minimum of 2 GB of hard disk space is recommended.

This USB scanner can only operate under the Microsoft Windows XP / Vista / 7 / 8 / 10 operating system.

## HARDWARE REQUIREMENTS

This scanner connects to your computer through the Universal Serial Bus (USB) which supports HOT PLUG AND PLAY. To determine whether your computer is USB-capable, you must check the rear of your PC to locate a USB jack that looks like the picture below. If you are having trouble in locating the USB port on your computer, please refer to the hardware manual that came with your computer.

Upon examination, you should find one or two rectangular USB ports, which usually appear as shown below.

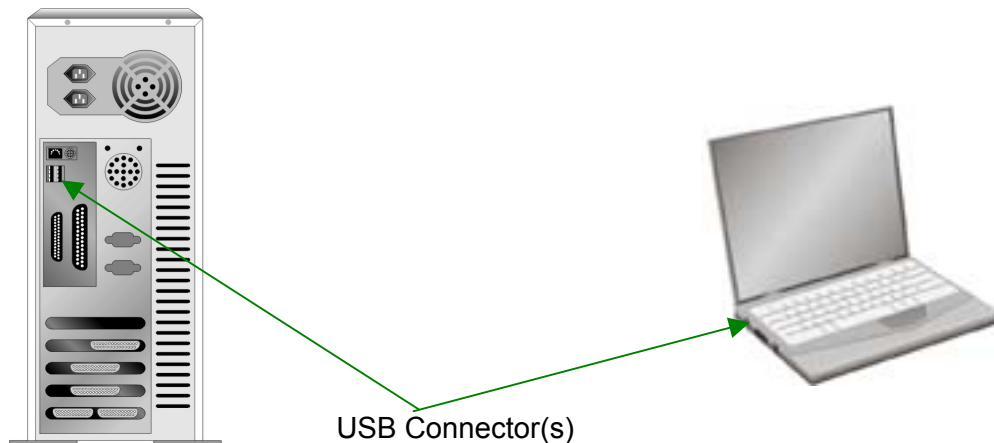

If you don't find such USB ports on your computer, then you need to purchase a certified USB interface card to add USB capabilities to your computer.

# INSTALLING AND SETTING UP THE SCANNER

Please follow the step-by-step procedures described below to install the Plustek scanner.

**Choose a Proper Site First!**

- Always place your scanner on a level, smooth and strong surface before proceeding the scanner setup or any scanning task.  
Tilted or uneven surface may cause paper-feeding errors, scanner damage or personal injury.
- Avoid using the scanner in a dusty environment. Dust particles and other foreign objects may damage the unit.



## Step 1. Install the Paper Chute

1. Open the ADF cover by pulling the lever, and get the paper chute ready.

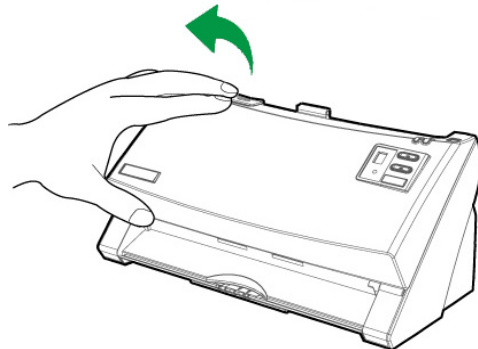

2. Install the paper chute by aligning and inserting the tabs of the paper chute into their slots on the scanner.

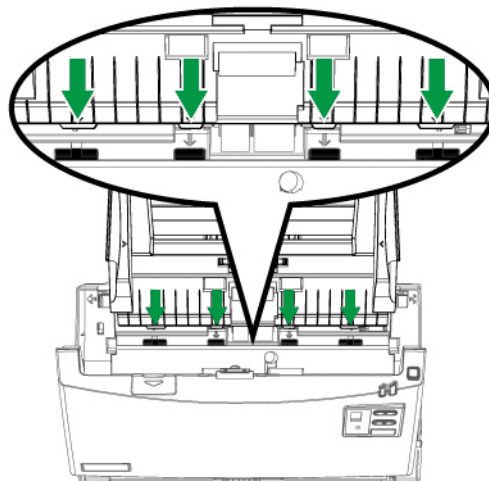



3. Close the ADF cover by pushing it back down until it snaps back into place.

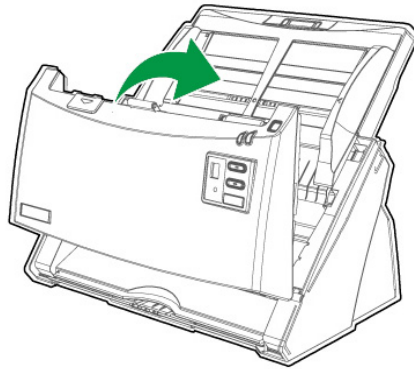

## Step 2. Connecting the Scanner to Your Computer

If your scanner does not have the USB hub function<sup>6</sup>, please follow the below connection steps:

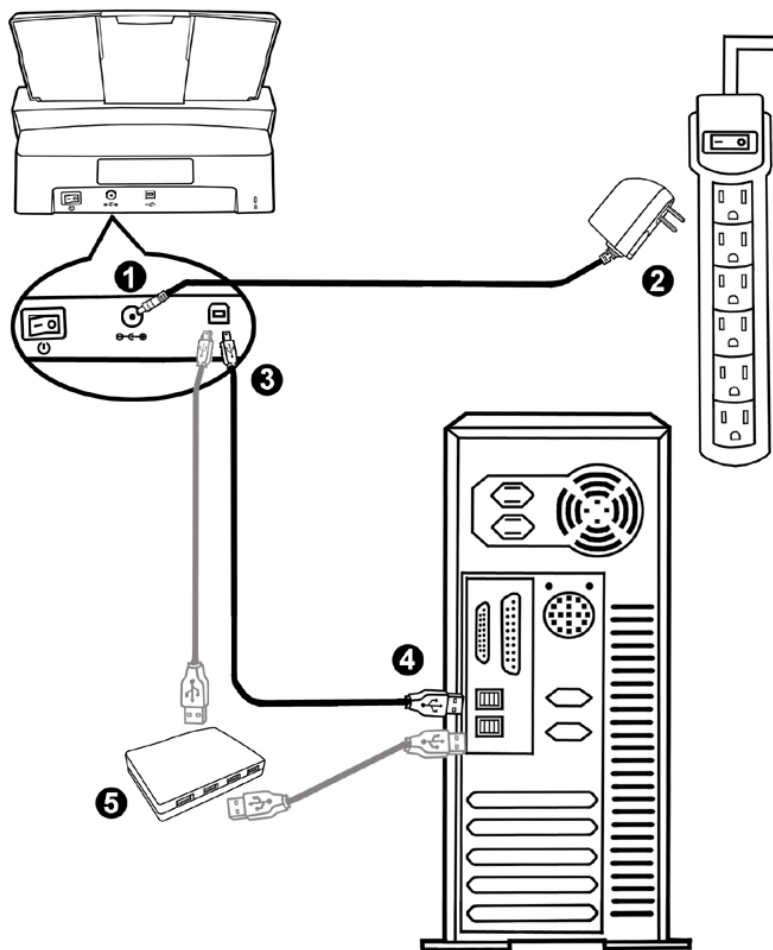



<sup>6</sup> This function may or may not be available depending on the scanner model you purchase.



**Attention**

Please make sure the scanner is turned OFF before you plug or unplug the scanner power adapter.

1. Plug the AC adapter into the scanner's power receptor .
2. Plug the other end of the AC adapter into a standard AC power outlet.
3. Plug the square end of the included USB cable to the USB port  at the rear of the scanner.
4. Plug the rectangular end of the USB cable to an available USB port on your computer.
5. If you plan to connect your scanner to a USB hub<sup>7</sup>, make sure that the hub is connected to the USB port in your computer. Next, connect the scanner to the USB hub.

**If your scanner has the USB hub function<sup>8</sup>, please follow the below connection steps:**

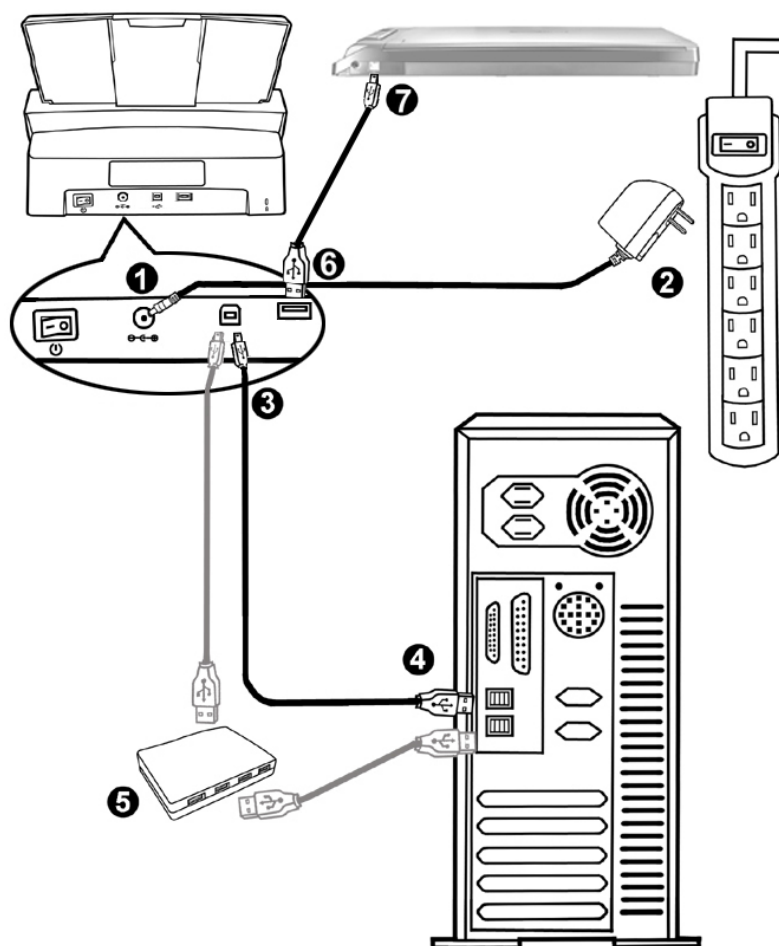



<sup>7</sup> The USB hub is not included with the scanner.

<sup>8</sup> This function may or may not be available depending on the scanner model you purchase.



### Attention

Please make sure the scanner is turned OFF before you plug or unplug the scanner power adapter.

1. Plug the AC adapter into the scanner's power receptor .
2. Plug the other end of the AC adapter into a standard AC power outlet.
3. Plug the square end of the included USB cable to the USB port  at the rear of the scanner.
4. Plug the rectangular end of the USB cable to an available USB port on your computer.
5. If you plan to connect your scanner to a USB hub<sup>9</sup>, make sure that the hub is connected to the USB port in your computer. Next, connect the scanner to the USB hub.
6. Plug the rectangular end of another USB cable to the USB hub at the rear of this scanner.
7. Plug the square end of another USB cable to the USB port of another scanner.

## Step 3. Installing the Software

1. Switch on the scanner power from the rear of the scanner.
2. If the USB components on your computer are functioning correctly, they will automatically detect the scanner causing the **Add New Hardware Wizard** or **Found New Hardware Wizard** to be launched.



### Information

If your computer is off when the scanner is connected, the "Add New Hardware Wizard" message will not be displayed until the computer is on and Windows starts.

3. For Windows XP:
  - a. Insert the Setup/Application DVD-ROM, included with your scanner, into your DVD-ROM drive.
  - b. Select **Install the software automatically recommended** and click the **Next** button.
  - c. Click the **Next** button in the window that appears. Afterwards, please skip to procedure 7.
4. For Windows Vista:
  - a. Select "Locate and install driver software (recommended)" when the "Found New Hardware" window is displayed.

---

<sup>9</sup> The USB hub is not included with the scanner.

- b. Click on the **Continue** button when the “User Account Control” dialog pops up.
- c. Insert the Setup/Application DVD-ROM, included with your scanner, into your DVD-ROM drive when the system prompts you “Insert the disc that came with your USB Scanner”, and click on the **Next** button. Afterwards, please skip to procedure 8.

5. For Windows 7:

When the Setup/Application DVD is for several scanner models

- a. Insert the Setup/Application DVD-ROM, included with your scanner, into your DVD-ROM drive. Click **Run install.exe** in the **AutoPlay** window.
- b. Click on the **Yes** button if the **User Account Control** dialog pops up. Follow the instructions in the pop-up installation message.
- c. In the **Device Manager** window, right-click on this scanner under **Other devices** and select **Update Driver Software** from the pop-up menu. Click **Browse my computer for driver software** in the window that appears, and click the **Browse** button.
- d. In the **Browse For Folder** window, select the folder or the DVD-ROM drive that contains this scanner’s driver and click the **OK** button to return to the previous screen. Click the **Next** button and click **Install this driver software anyway** if the **Windows Security** window appears. Afterwards, please skip to procedure 9.

When the Setup/Application DVD is for one scanner model

- a. Insert the Setup/Application DVD-ROM, included with your scanner, into your DVD-ROM drive. Click **Run install.exe** in the **AutoPlay** window.
  - b. Click on the **Yes** button if the **User Account Control** dialog pops up. Afterwards, please skip to procedure 9.
6. For Windows 8 & Windows 10:
- a. Insert the Setup/Application DVD-ROM, included with your scanner, into your DVD-ROM drive. Click on the pop-up notification, then click **Run install.exe** in the pop-up window. If you miss the pop-up notification, please eject and re-insert the Setup/Application DVD-ROM.
  - b. Click on the **Yes** button if the **User Account Control** dialog pops up. Afterwards, please skip to procedure 9.
7. During the process of the installation, a message “Windows can’t verify the publisher of this driver software” might be prompted. Please ignore it, and click on **Install this driver software anyway** to continue the installation without any misgiving at your scanner functioning.
8. When the system completes the installation, click the **Finish** button.

9. Follow the on-screen instructions to install all software that your new scanner requires. If the pop-up wizard window appears click **Next**, and click **Install this driver software anyway** in the **Windows Security** window then click **Finish** in the wizard window.
10. After the software is installed, close all open applications and click the **Finish** button to restart your computer.

|   |   |
|---|---|
| <br><b>Attention</b> | Save the Setup/Application DVD in case you need to reinstall the driver and software in the future. |
|---|---|

## Step 4. Testing the Scanner

The following describes how you can check if the scanner is properly functioning with your computer and the scanning software. Before testing your scanner, double check to make sure that all connections are securely fastened.

### To test the ADF scanning:

1. Load a document headfirst and face down into the ADF with the text side facing the paper chute.

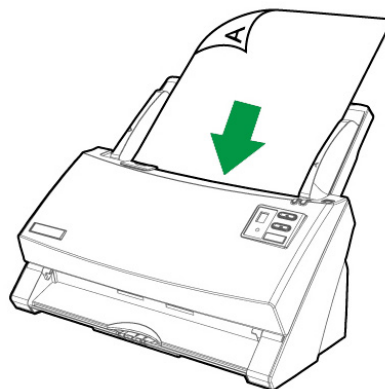

2. Double-click the icon  in the Windows system tray.
3. Within the “Button Configuration” window, select a task number by clicking on the icon. Select the desired function from the drop-down list of Button Template and adjust button settings. Select **ADF (Front Side)** as the Scan Type. Click **OK** to exit the “Button Configuration” window.

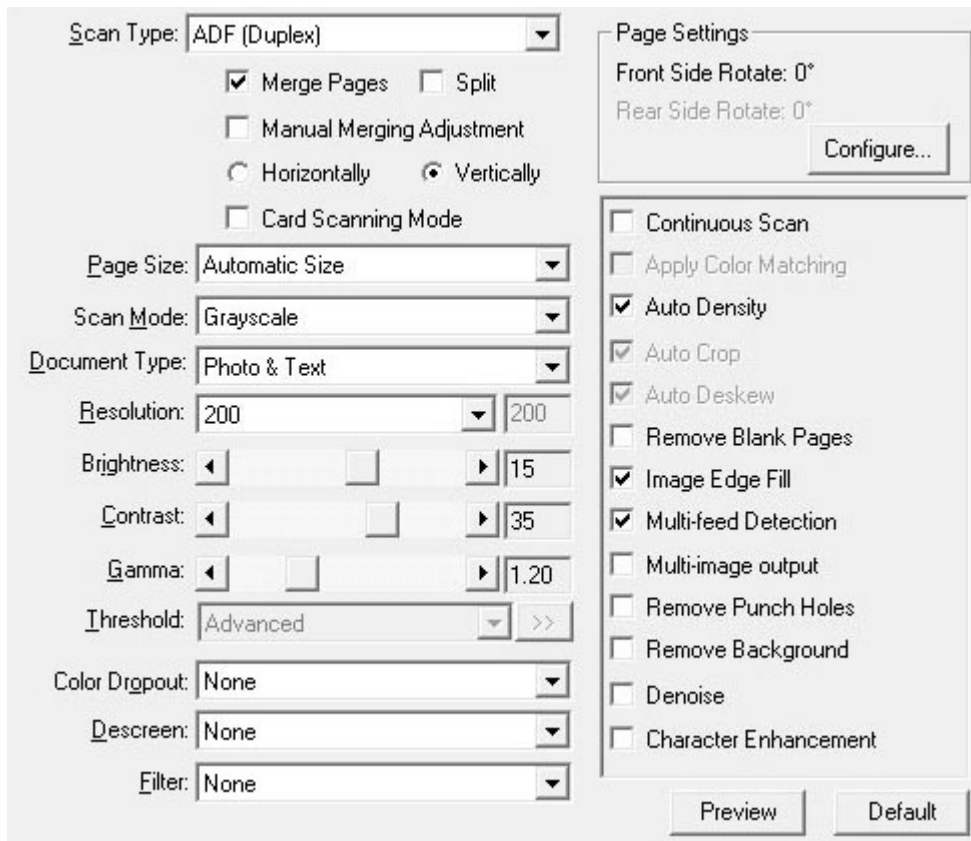

- Right-click the icon  in the Windows system tray, and then choose **Execute** in the pop-up menu that opens. Click the desired button function item in the pop-up menu.

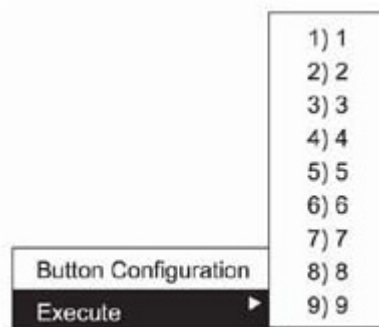

- The document in the ADF paper chute should be now loaded into the ADF and scanned. The scanner starts to scan immediately and carry out the corresponding action according to settings you have set up in the “Button Configuration” window.

## INSTALLING ADDITIONAL SOFTWARE

Your scanner is TWAIN compliant and functions with virtually all available TWAIN compatible software. If you purchase additional software to be used with your scanner, please make sure that it conforms to the TWAIN standard.

## CHAPTER II. SCANNING

Your scanner needs to be driven by certain type of software program. Since all documents or images (whether text or pictures) that are acquired from the scanner are treated by your computer as images, most scanning will probably be done from an image-editing program where you can view, edit, save and output the scanned images.

What about scanning text documents and editing them in a word processor? This is the role of Optical Character Recognition (OCR) software. OCR software converts the image files that are created from scanning text documents into text files that can be viewed, edited and saved by word processors.

The DocAction program, seamlessly integrating the operation of your scanner with your computer and other peripherals, provides a quick and convenient way to perform various scanning functions. With DocAction, you don't need to adjust settings every time you scan. Simply press any button on the scanner's front panel or click any scanning menu item of DocAction on the screen. The scanner starts to scan your paper documents and transfer them to your assigned destination. The destination can be a printer, your E-mail program, files on your disk drives, an image-editing program, etc.

Please refer to the online help of each program to guide you through any questions you may have while scanning within that program.

This chapter describes three important steps of scanner operations. Read them thoroughly and follow the instructions to ensure correct use and optimal scanner performance.

Step 1. Preparing Documents

Step 2. Placing Documents, Placing Business Cards, Placing Plastic Cards

Step 3. Scanning Documents

### PREPARING DOCUMENTS

Proper document preparation prior to the scan can prevent paper feed errors and damages to the scanner.

- Checking Document Conditions

- Loosening Documents

## Checking Document Conditions

Make sure the size and ream weight of your documents are acceptable by the scanner. Refer to “Appendix A: Specifications” of this guide for more information.

To scan multiple documents in a batch from the ADF can increase your work efficiency and make large scanning tasks easier. The ADF of this scanner accepts a variety of paper and stationery you may use in your daily work or personal life, such as:

- Normal paper whose size and ream weight meet the requirements stated in “Appendix A: Specifications” of this guide.
- Notched paper
- Coated paper (e.g., brochure)



### Attention

To prevent paper feeding errors and damages to the ADF unit, strictly follow the instructions below:

- Remove all small objects e.g., paper clips, pins, staples or any other fasteners attached, before loading the paper into the ADF.
- Make sure the paper is completely flat with no creased or curled corners.
- Avoid scanning documents with pencil lead and newspaper clippings as they will make the ADF exposure glass and the inner ADF dirty. If you have to scan such paper, clean the scanner frequently (refer to “Chapter III. Care and Maintenance” of this guide for more information).
- The paper for each batch scanned by ADF can be of the same or different weights. However, make sure the length of each scan batch is the same.



However, don't use the ADF to scan documents if they meet any of the following conditions:

- Paper lighter than 40 g/m<sup>2</sup> (10 lb.) or heavier than 220 g/m<sup>2</sup> (58 lb.)
- Paper with clips or staples attached
- Paper with inconsistent thickness, e.g., envelopes
- Paper with wrinkles, curls, folds, or tears
- Paper with an odd (non-rectangular) shape
- Paper with static electricity
- Tracing paper
- Carbon paper, pressure sensitive paper, carbonless paper
- Items other than paper, e.g., cloth, metal foil.



**Attention**

- DO NOT use the ADF to scan photographic sheets or particularly valuable document originals; wrinkles or other damages can happen in case of paper feeding errors.
- DO NOT place paper with wet ink or correction fluid into the ADF. Wait few minutes for it to get dry.

## Loosening Documents

Before loading documents into the ADF, loosen them as follows:

1. Fan the documents so that no two pages are sticking together. Make sure to remove static electricity from paper.

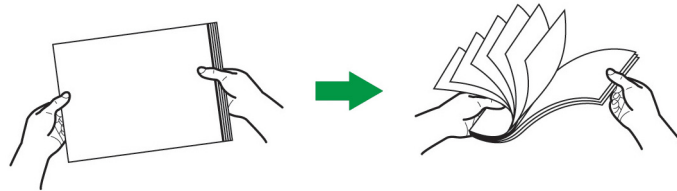

2. Hold the documents upside down with both hands, and then gently push them onto a flat surface to align the edges of all documents.



This will allow documents being fed into the ADF one at a time and prevent paper-feeding errors.

## PLACING DOCUMENTS

1. Load the documents, headfirst and face down, toward the center of the ADF paper chute and all the way into the ADF until touching the bottom.

For single-sided scans, load the documents face down so that the side to be scanned faces towards the paper chute.

For double-sided scans, load the desired page order of documents face down so that the side to be scanned faces towards the paper chute.

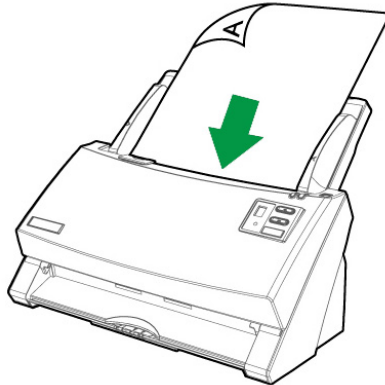

2. If you need to scan longer documents, pull out the paper chute extension and stacker to provide further support for the documents.

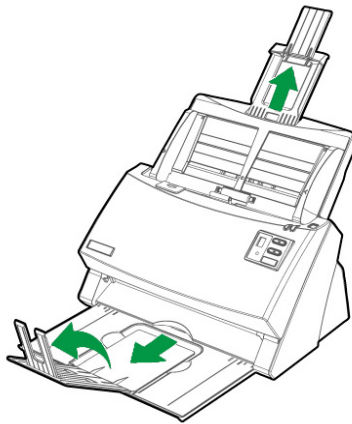

3. Adjust the paper width slider for the paper size you are using. The paper width slider should be gently touching both sides of the documents.

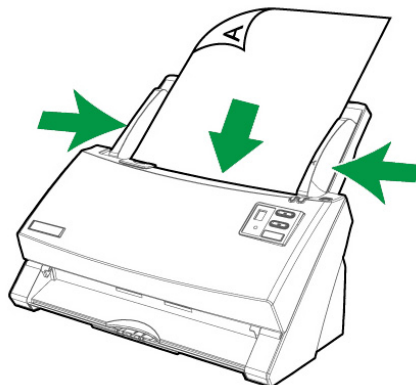



**Attention**

- DO NOT load more than 100 sheets of paper to the ADF.
- Paper scanned from the ADF must be a minimum of 5.08 x 5.08 cm (2" x 2", W x L).
- Make sure there are no gaps between the document stack and the paper-width slider; otherwise, the scanned images can be skewed.
- Although the documents should be loaded firmly in place ensuring optimum scanning accuracy, they should never be wedged in so tightly that the process of feeding them through the scanner is strained.
- Do not load additional paper into the ADF while the unit is feeding and scanning.

## PLACING BUSINESS CARDS

1. Horizontally load the business cards, headfirst and face down, toward the center of the ADF and all the way into the ADF until touching the bottom.

For single-sided scans, load the business cards face down.

For double-sided scans, load the business cards in desired order.

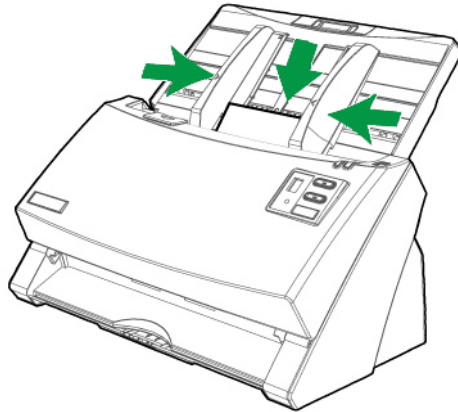

2. Adjust the paper width slider to the business card width. The paper width slider should be gently touching both sides of the business cards.



### Attention

- Make sure the business cards you wish to scan are horizontally loaded into the ADF.
- Don't load more than 30 business cards in one batch.

## PLACING PLASTIC CARDS

The plastic card can be embossed credit card, driver license, ID card, insurance card, medic-care card or any membership card. Make sure to load the embossed face of the embossed card face up into the scanner.

1. Horizontally load the plastic card, headfirst and face up, toward the center of the ADF.

For single-sided scans, load the card face up.

For double-sided scans, load the card in desired order.

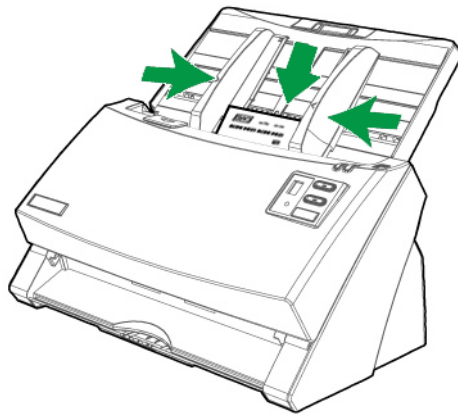

2. Adjust the paper width slider to the card width. The paper width slider should be gently touching both sides of the card.



### Attention

- Make sure the plastic cards you wish to scan are horizontally loaded into the ADF.
- Maximum thickness of each plastic card is 1.2 mm.

## INSTALLING THE MIX-PAPER SCAN FRAME<sup>10</sup>

Mix-paper scan frame helps to reduce the skewness of the scanned documents when users scan mix batch documents with different paper sizes and thicknesses.

1. Gently pull the frame holders on both sides of the frame.

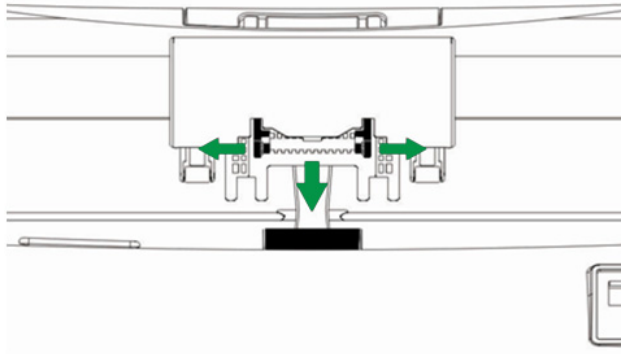

2. Install the frame by inserting the frame holder tabs onto their slots on the friction roller module.

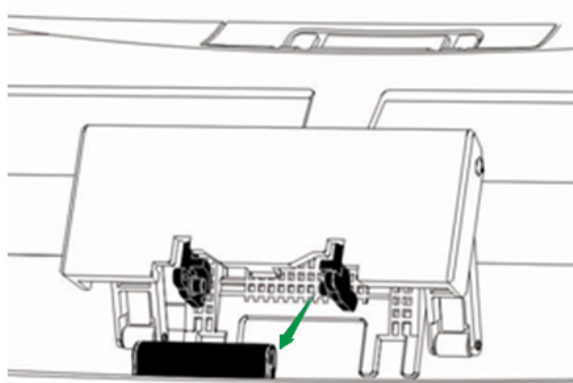

Please gently remove the frame by pulling the frame holders on both sides of the frame. Directly pulling the whole frame will cause the frame damage.

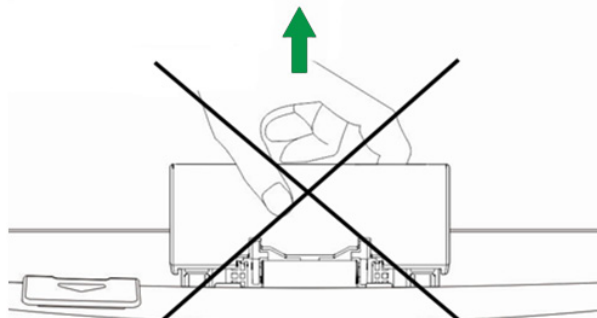

<sup>10</sup> The mix-paper scan frame is not included in all scanner models.

## SCANNING DOCUMENTS

There are 4 different ways to operate the scanner:

1. By acquiring images from the scanner through our TWAIN interface within any TWAIN-compliant application programs.
2. By scanning from the buttons on the scanner front panel.
3. By scanning from DocAction's Execute menu on the screen.
4. By scanning from the icon in the left side of the DocAction window.

The TWAIN interface and DocAction software are automatically installed to your system along with the scanner driver.



**Attention**

Before you start scanning, check the following:

- The power of both your computer and scanner is turned on.
- The icon  appears on the Windows system tray.
- Paper is appropriately loaded into the ADF.

### Scanning via TWAIN Interface

The TWAIN program is a very important piece of software that comes with your scanner. This program acts as an interface between the scanner hardware and the image-editing software you are using to view and edit images. The TWAIN program allows you to adjust a number of settings to define the quality of the scanned image.

The following describes how you may use your TWAIN compatible program to scan via the TWAIN interface. When you get familiar with the scanning, you may alternatively use other TWAIN compatible scanning program or image-editing application to do your scanning projects.

#### Select the Scan Source:

If you have more than one scanner or other imaging devices installed on your computer, you need to set this scanner as the default scanning source before you acquire TWAIN program. Please refer to your TWAIN compatible program manual for more information about the settings.

#### Scan within your TWAIN compatible program:

1. Launch your TWAIN compatible program.
2. Open the TWAIN window within your TWAIN compatible program. Please refer to your TWAIN compatible program manual for detailed information.



3. In the TWAIN window that opens, select **ADF (Front Side)** as the Scan Type if you want to scan single-sided documents, or select **ADF (Duplex)** to scan double-sided documents.

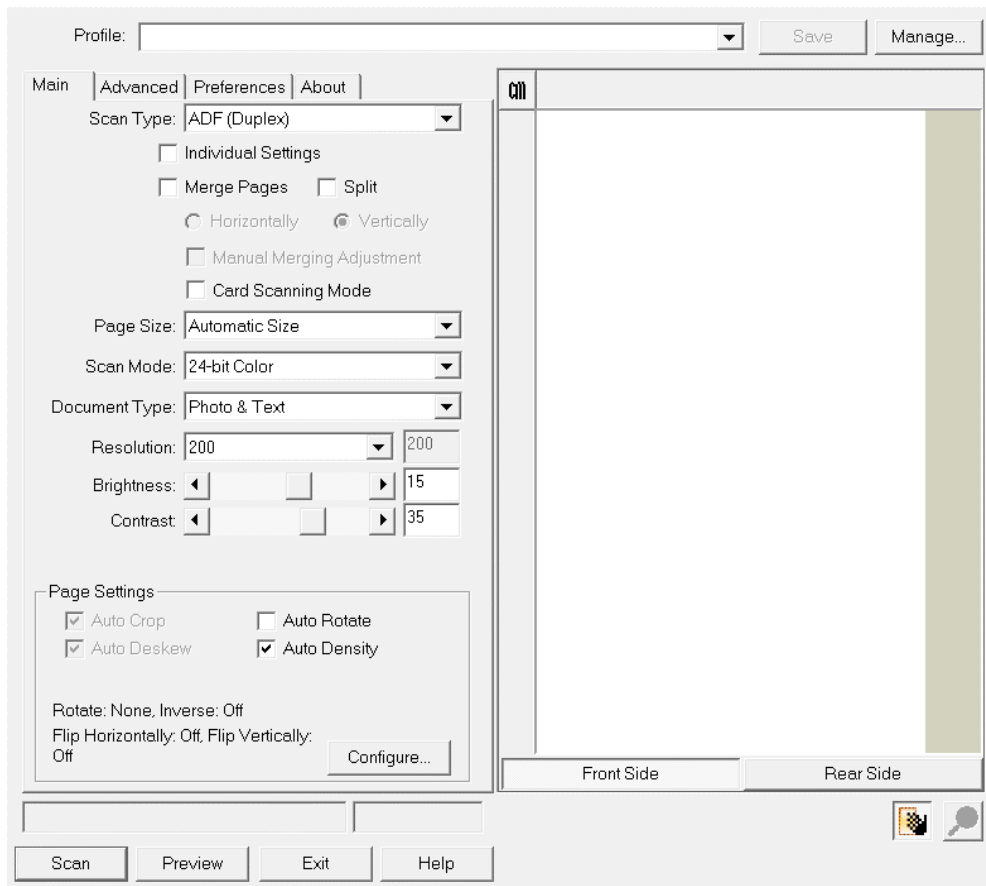

4. Adjust the scanning settings. For **ADF (Duplex)** scan, you can tailor settings individually for front and rear sides of the documents. Click **Front Side** button to adjust the scanning settings of document front side and then click **Rear Side** button to adjust the scanning settings of document rear side. You can enable the function of **Merge Pages** only when you select **ADF (Duplex)** as **Scan type** and **Automatic Size** as **Page Size** to output the scan images of both front and rear sides in one image. After the function of **Merge Pages** is enabled, you can make the selection of **Horizontally** to generate both front and rear image data horizontally in a joined image (the rear image will be placed at the right side next to the front image), or make the selection of **Vertically** to generate both front and rear image data vertically in a joined image (the rear image will be placed below the front image).
5. Load one page of the document and click the **Preview** button. The scanned image should appear in the Preview Window. To define the margins and crop out sections of the image you don't want scanned, use the mouse to click and drag the corners or sides of the scan area borders. Adjust the scan settings again if the preview image doesn't satisfy your needs.

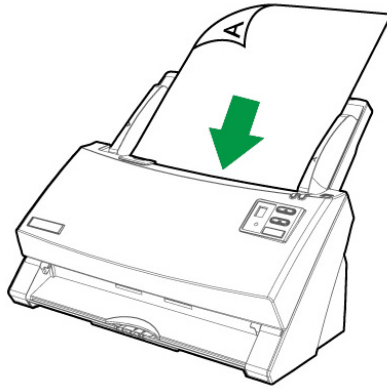

6. Load all pages of the document and click the **Scan** button.
7. When the scan finishes, click the **Exit** button to close the TWAIN window. The scanned images are displayed in your TWAIN compatible program, and you may perform the image editing tasks.

Click the **Help** button within the TWAIN window for more information about the settings.

## **Scanning from the Scanner's Front Panel**

To complete your scanning projects by using the scanner buttons is very easy and convenient. The number of scanning task displayed on the scanner's front panel is configured through DocAction. DocAction offers you quick access to the most frequently-used scanning functions. They are especially useful when you need to repeatedly scan with the same settings and send images to the same destination. Before performing your first scan via scanner buttons, you are recommended to configure the button settings to your needs and preferences first.

## Scan from the Scanner Buttons

1. Place the document or images onto the scanner. (Refer to “Chapter II. Scanning” of the Scanner User’s Guide for more information in placing paper into the ADF properly.)

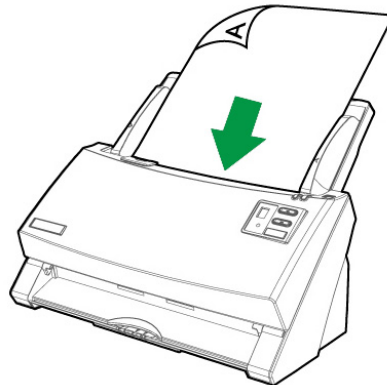

2. Check current button settings by viewing the Button Configuration window. If needed, you may also modify settings to meet your current needs. (Refer to “View Button Settings” and “Configure Button Settings” below for more information.)

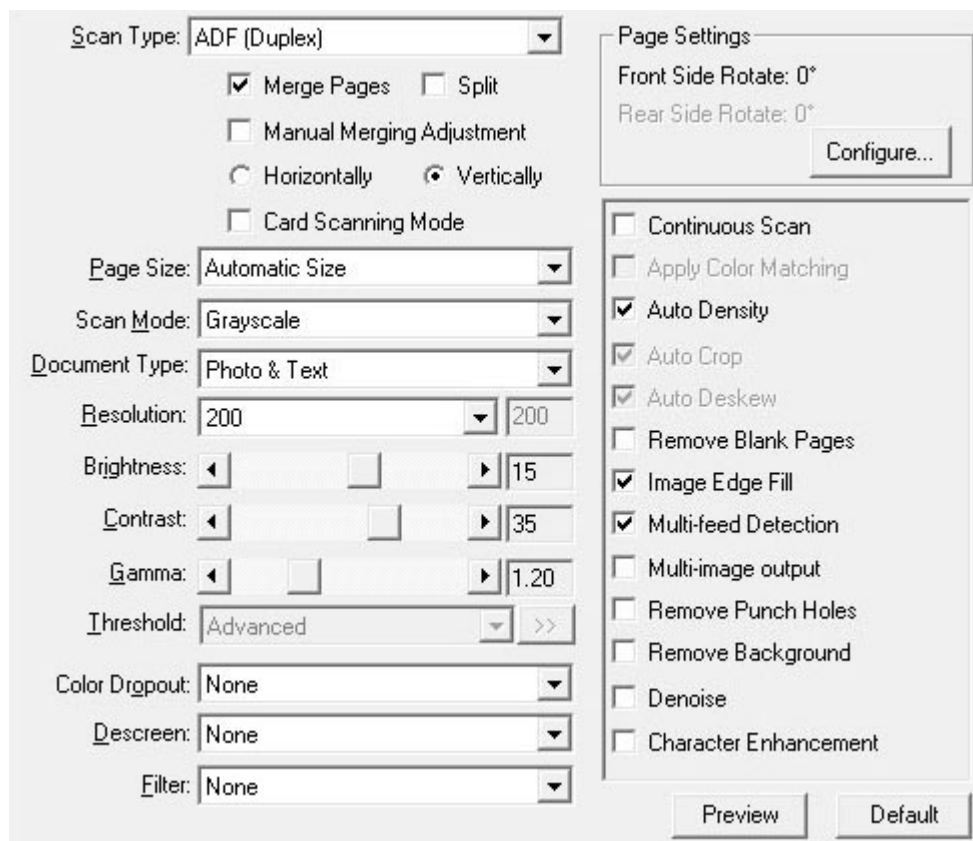
A screenshot of a software window titled "Button Configuration". The window is divided into several sections. On the left, there are settings for "Scan Type" (ADF (Duplex)), "Merge Pages" (checked), "Split" (unchecked), "Manual Merging Adjustment" (unchecked), "Horizontally" (unchecked), "Vertically" (checked), and "Card Scanning Mode" (unchecked). Below these are "Page Size" (Automatic Size), "Scan Mode" (Grayscale), "Document Type" (Photo & Text), "Resolution" (200), "Brightness" (15), "Contrast" (35), "Gamma" (1.20), "Threshold" (Advanced), "Color Dropout" (None), "Descreen" (None), and "Filter" (None). On the right, there is a "Page Settings" section with "Front Side Rotate: 0°" and "Rear Side Rotate: 0°", and a "Configure..." button. Below that is a list of checkboxes: "Continuous Scan" (unchecked), "Apply Color Matching" (unchecked), "Auto Density" (checked), "Auto Crop" (checked), "Auto Deskew" (checked), "Remove Blank Pages" (unchecked), "Image Edge Fill" (checked), "Multi-feed Detection" (checked), "Multi-image output" (unchecked), "Remove Punch Holes" (unchecked), "Remove Background" (unchecked), "Denoise" (unchecked), and "Character Enhancement" (unchecked). At the bottom right, there are "Preview" and "Default" buttons.

3. Press the UP or DOWN button to select the desired task.

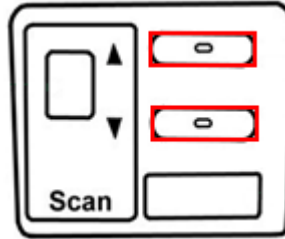

4. Press the **Scan** button.

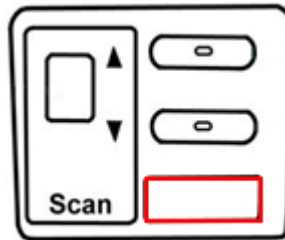

The scanner starts to scan immediately and carry out the corresponding action according to settings you have set up in the Button Configuration window.





**Attention**

Place only text documents for OCR purposes. Do not scan a photo using the OCR button.

## Configure Button Settings

Within the “Button Configuration” window, you can find a row of icons running through the left side of the window. Each icon represents a scanning task, and the number underneath corresponds to the function number displayed on the scanner front panel. Nine frequently-used scanning tasks are pre-configured for your convenience to start scanning immediately. You may, however, customize the settings of every nine tasks to best meet your needs and preferences. Follow the steps described below:

1. Do one of the following to open the Button Configuration window:

- Double-click the icon  in the Windows system tray.
- Right-click the icon  in the Windows system tray, and then choose **Button Configuration...** in the pop-up menu that opens.

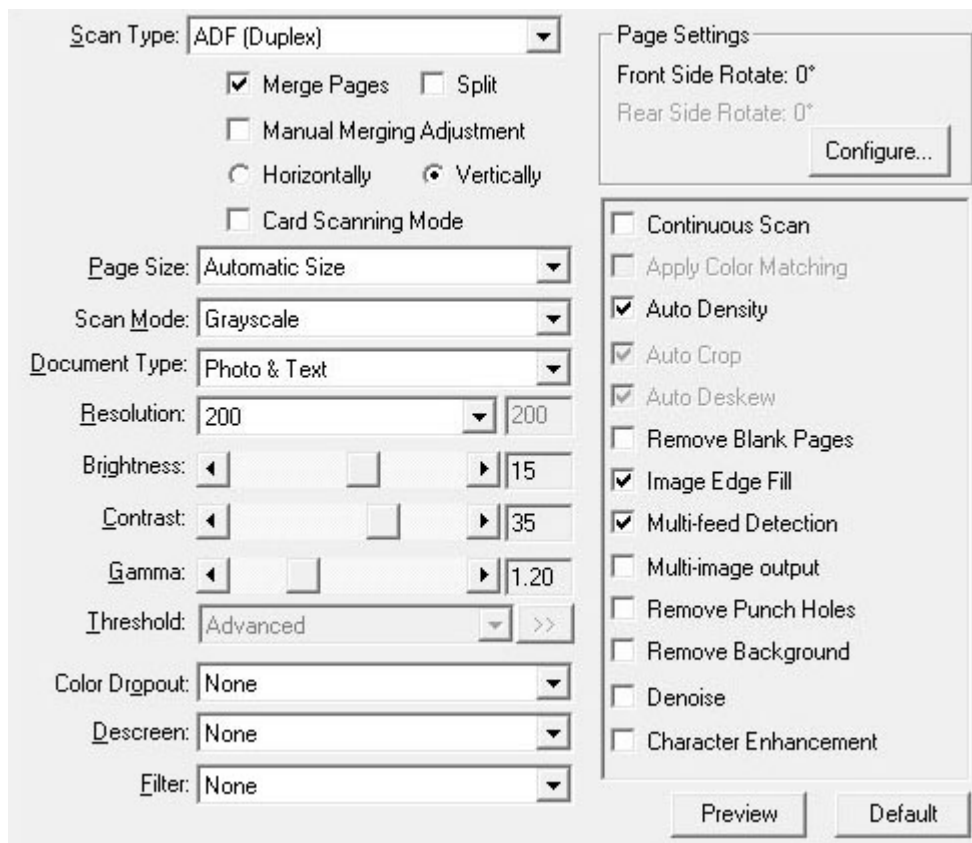

2. Select a task number by clicking on the icon.

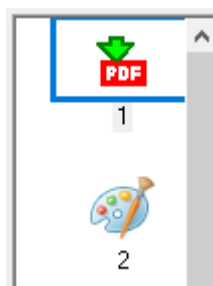

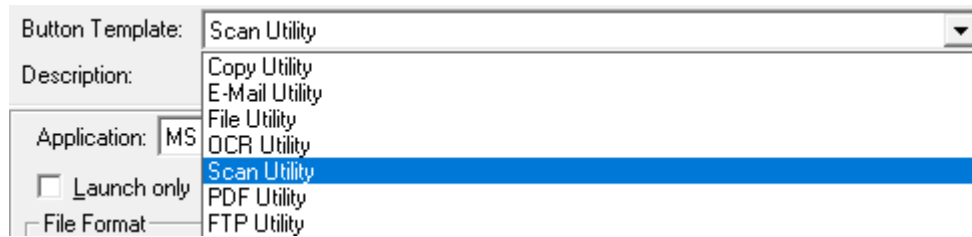

3. Select the desired function from the drop-down list of Button Template and adjust button settings.



Click the **Help** button within the Button Configuration window for more information about the settings.

### View Button Settings

There are 2 ways to view the button settings:

- Double-click the icon  in the Windows system tray.
- Right-click the icon  in the Windows system tray, and then choose **Button Configuration...** in the pop-up menu that opens.

## Scanning from the On-screen DocAction's Execute Menu

You may also use DocAction's on-screen Execute menu to perform the same scanning tasks. The DocAction program provides a quick and convenient way to perform various scanning functions. Follow the steps described below:

1. Place the document or images onto the scanner.

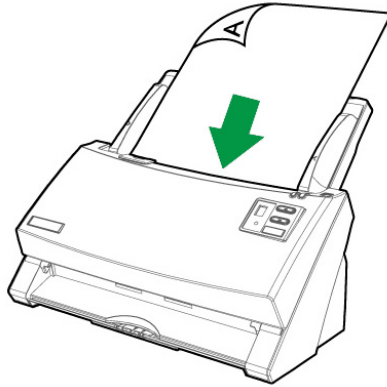

2. Check current button settings by viewing the Button Configuration window. If needed, you may also modify settings to meet your current needs.

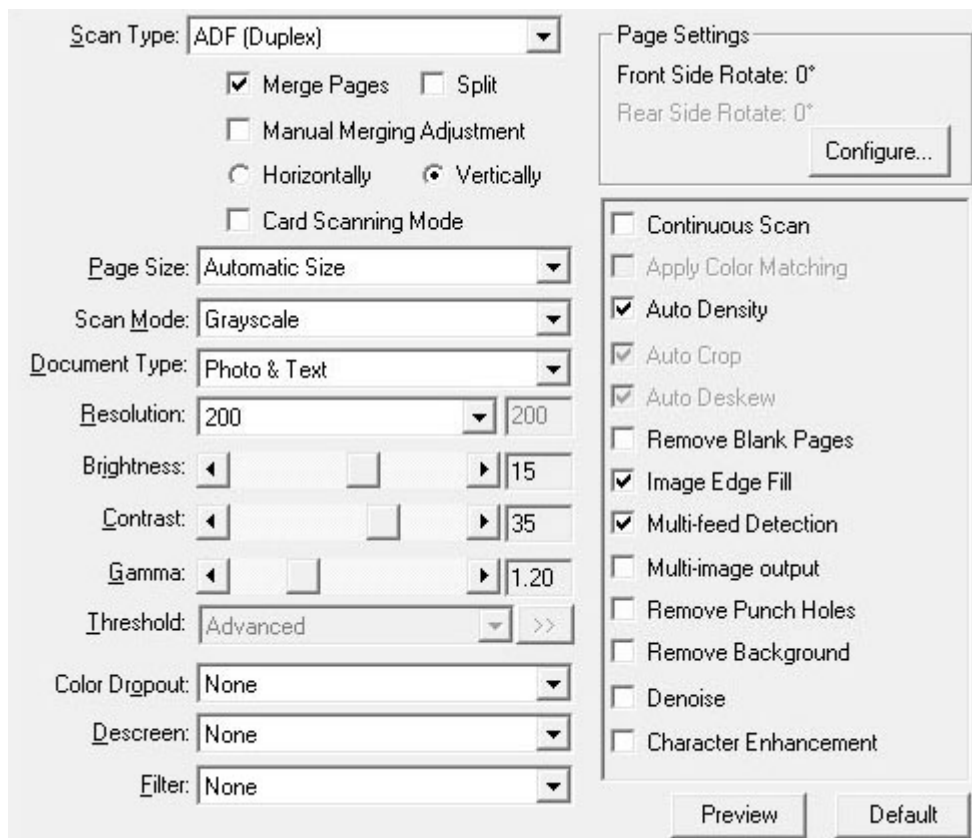
A screenshot of the DocAction software interface. The window is divided into several sections. On the left, there are settings for Scan Type (ADF (Duplex)), Merge Pages (checked), Split (unchecked), Manual Merging Adjustment (unchecked), Orientation (Vertically selected), Card Scanning Mode (unchecked), Page Size (Automatic Size), Scan Mode (Grayscale), Document Type (Photo & Text), Resolution (200), Brightness (15), Contrast (35), Gamma (1.20), Threshold (Advanced), Color Dropout (None), Descreen (None), and Filter (None). On the right, there is a Page Settings section with Front Side Rotate (0°) and Rear Side Rotate (0°), and a Configure... button. Below that is a list of checkboxes for various options: Continuous Scan, Apply Color Matching, Auto Density (checked), Auto Crop (checked), Auto Deskew (checked), Remove Blank Pages, Image Edge Fill (checked), Multi-feed Detection (checked), Multi-image output, Remove Punch Holes, Remove Background, Denoise, and Character Enhancement. At the bottom right, there are Preview and Default buttons.

3. Right-click the icon  in the Windows system tray, and then choose **Execute** in the pop-up menu that opens.

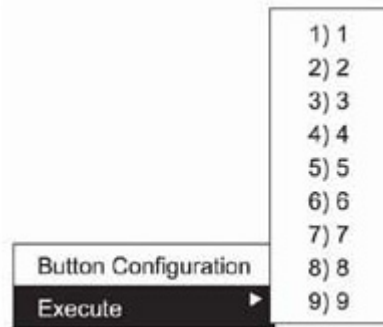

4. Click the desired button function item in the pop-up menu.

The scanner starts to scan immediately and carry out the corresponding action according to settings you have set up in the Button Configuration window.

## Scanning from the Icon in the Left Side of the DocAction Window

You can perform scanning task by double-clicking the icon in the left side of the DocAction window. Follow the steps described below:

1. Place the document or images onto the scanner.

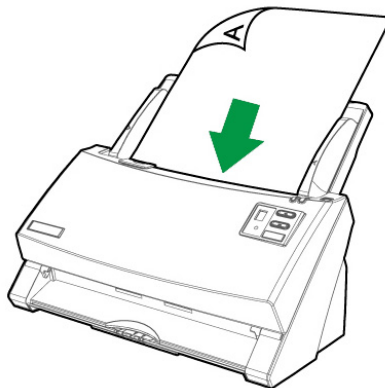

2. Check current button settings by viewing the Button Configuration window. If needed, you may also modify settings to meet your current needs.



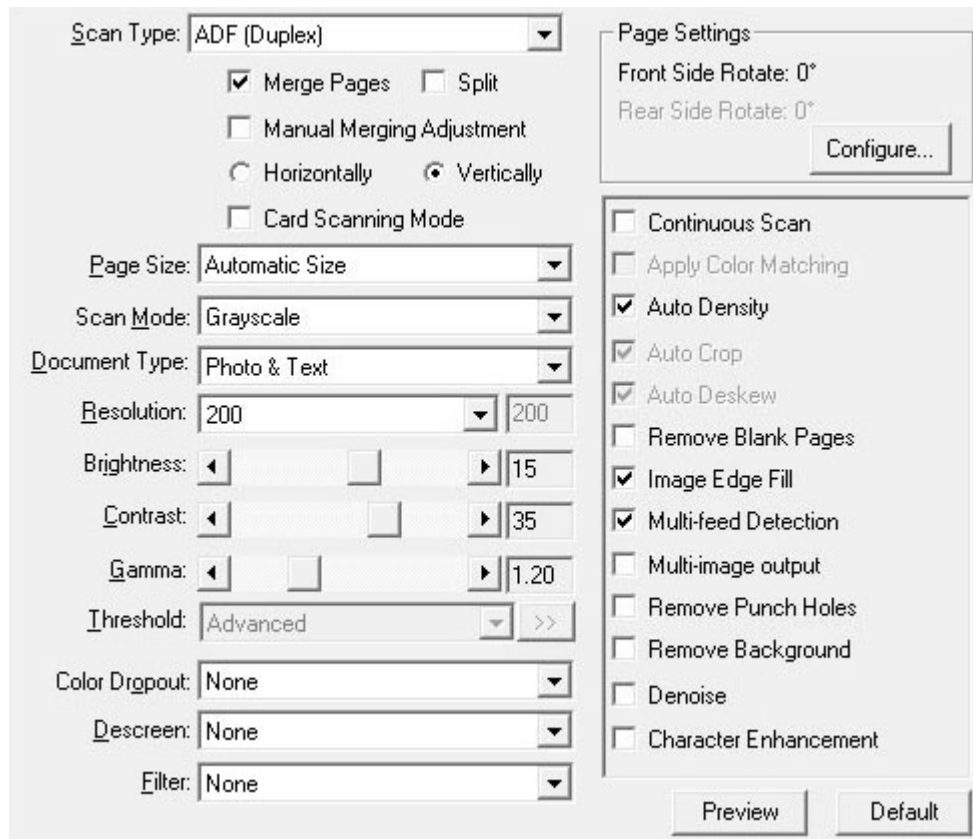

3. Double-clicking the desired icon in the left side of the DocAction window.

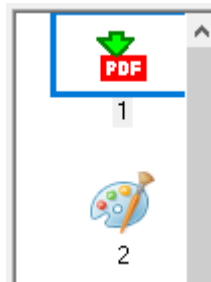

The scanner starts to scan immediately and carry out the corresponding action according to settings you have set up in the Button Configuration window.

## CHAPTER III. CARE AND MAINTENANCE

Your scanner is designed to be maintenance-free. However, constant care and maintenance can keep your scanner working smoothly.

### CLEANING THE SCANNER

Paper powder, dust, ink and toner from paper being scanned may make the inner ADF dirty, which leads to poor image quality or document-feeding errors. How often to clean your scanner depends on the type of paper and number of pages being scanned.

Perform the following procedures to clean the scanner surface and the ADF unit. Gently wipe locations described herein. Do not rub too hard.



**Warning**

- Before cleaning the scanner, turn off the scanner and disconnect the scanner's power cable and USB cable, and then wait a few minutes for the glass and/or the inner ADF to cool to ambient temperature.
- Wash your hands with soap and water after cleaning the scanner.

### Cleaning Materials

Have the following cleaning materials ready to clean the scanner:

- **soft, dry, lint-free cloth (or a cotton swab)**
- **non-abrasive cleaner**—Isopropyl alcohol (95%). DO NOT use water.



**Attention**

- Alternatively you can use glass cleaner or neutral detergent for windows cleaning to clean the scanner glass.
- However, DO NOT use either of them to clean the ADF feed roller or friction roller module.
- Use of other cleaning materials could damage your scanner.

## Cleaning the ADF

1. Open the ADF cover by pulling the lever.

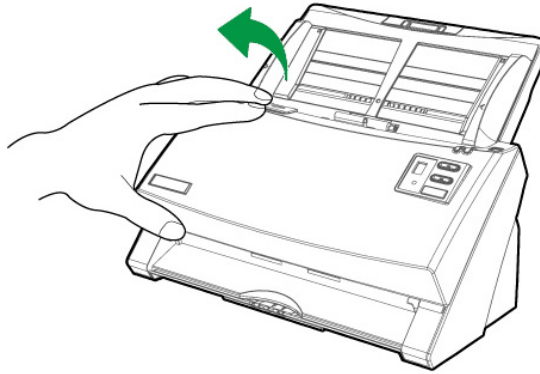

2. Gently wipe the following areas with the cloth dampened with the cleaner. Be careful NOT to scratch their surfaces.

### Clean Feed Roller:

Wipe the Feed Roller from side to side and then rotate it. Repeat this until its entire surface is cleaned.

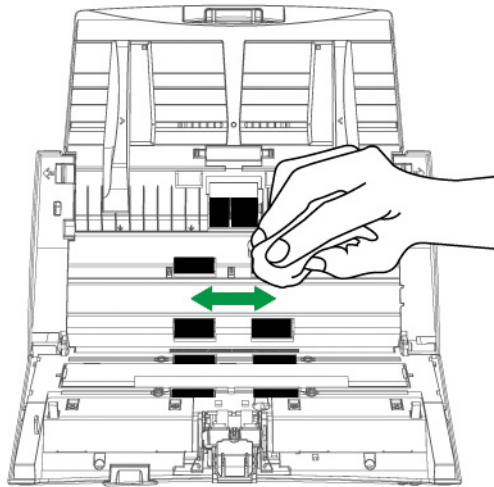

### Clean Friction Roller Module:

Wipe the friction roller module from top to bottom (in the direction of arrow shown in the picture). Be careful not to damage the pick springs of the friction roller module.

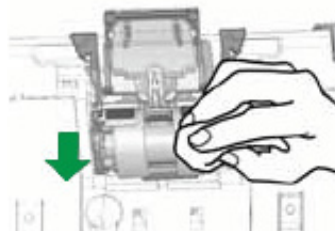

## Clean ADF Glass:

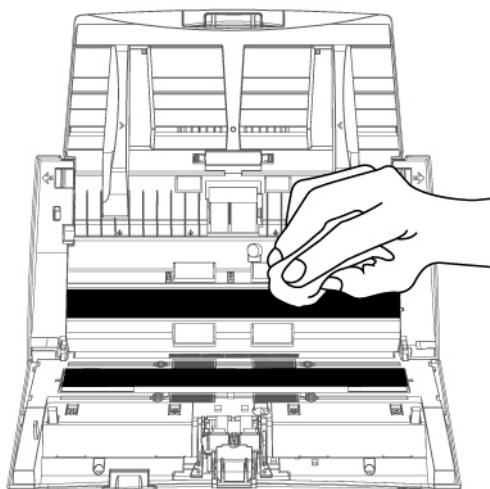

Do not spray cleaner directly onto the scanner glass. Excess liquid residue may fog or damage the scanner.

3. Wait for cleaned areas to dry completely.
4. Close the ADF cover by pushing it back down until it snaps back into place.

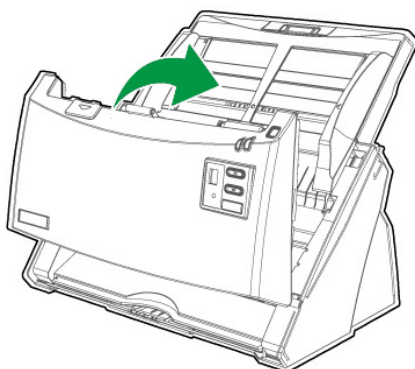

## REPLACING CONSUMABLES

As a guideline, it is recommended to replace the friction roller module every 100000 sheets of scans (A4), and it is recommended to replace the feed roller every 300000 sheets of scans (A4). The Counter Utility program automatically counts the number of sheets scanned by your scanner and how many times the consumables are used. After replacing consumables, please reset the counter to 0. From the Windows **START** menu, point to **All Programs > Your Scanner Model Name**, and then click **Scanner Utility**. (For Windows 8.1 users: Point your mouse cursor to the upper or lower right corner of your screen to open the **Charm** bar. Click on the **Start** charm, then click on the downwards arrow button in the lower left corner of the screen. The **Apps** screen will be shown. Move your cursor to the right edge of the screen to scroll right until you find **Your scanner model name**, and then click on **Scanner Utility**.) The Scanner Utility window opens. Find the Counter Utility section. Refer to the online help of Scanner Utility to explore more about Counter Utility.

### Replacing the Friction Roller Module

1. Open the ADF cover by pulling the cover open lever.

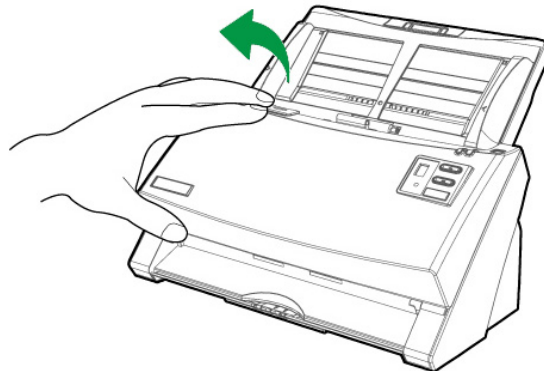

2. Remove the friction roller module by pinching both sides of the friction roller module and pull it out.

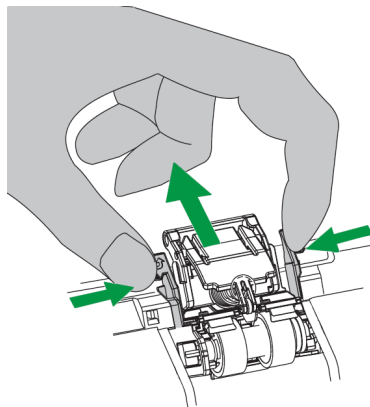

3. Install the new friction roller module by inserting the tab on the module onto the slot on the scanner.

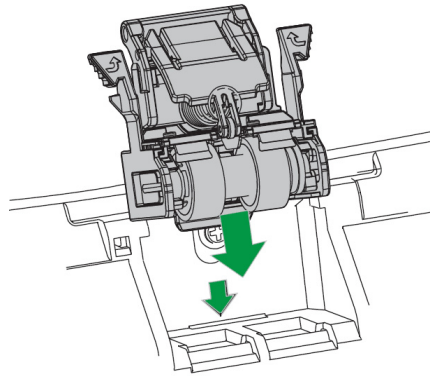

4. Close the ADF cover by pushing it back down until it snaps back into place.

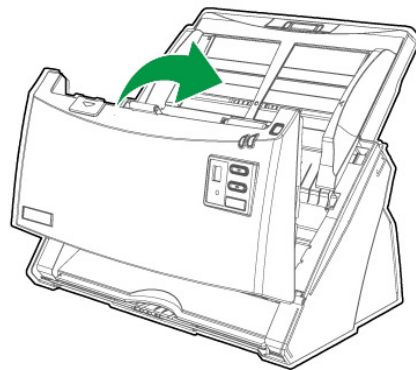

## Replacing the Feed Roller

1. Open the ADF cover by pulling the cover open lever.

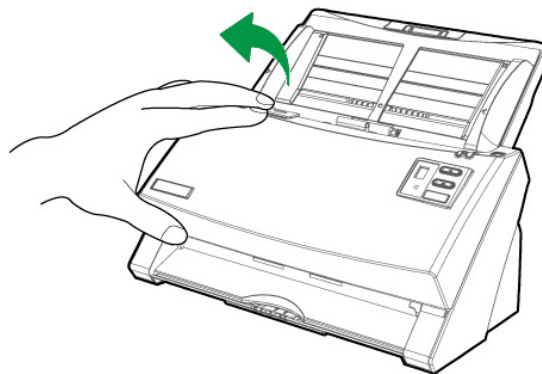

2. Remove the paper chute by pinching both sides of the handles on the paper chute to remove it.

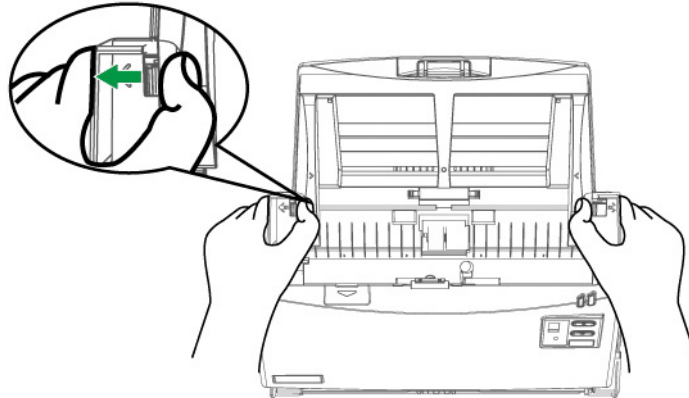

3. Remove the feed roller by pinching both sides of the feed roller and pull it out.

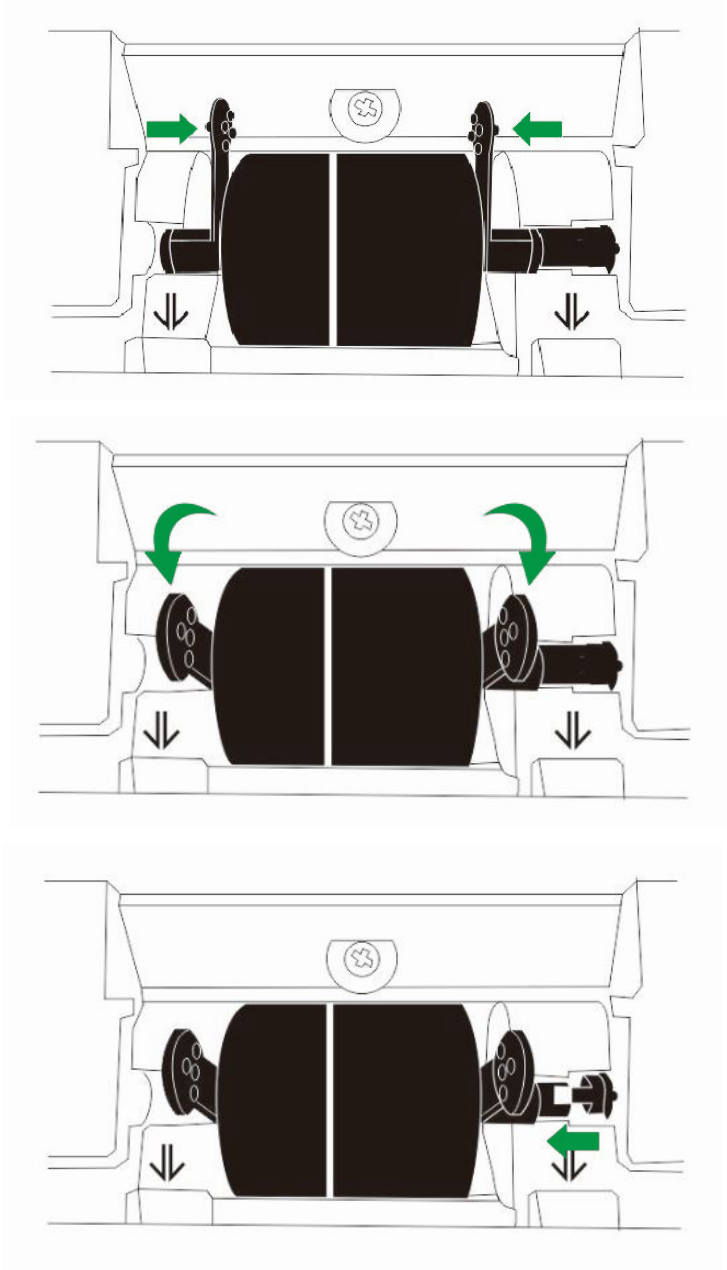

4. Install the new feed roller by aligning and inserting the feed roller onto the roller pitman on the scanner.

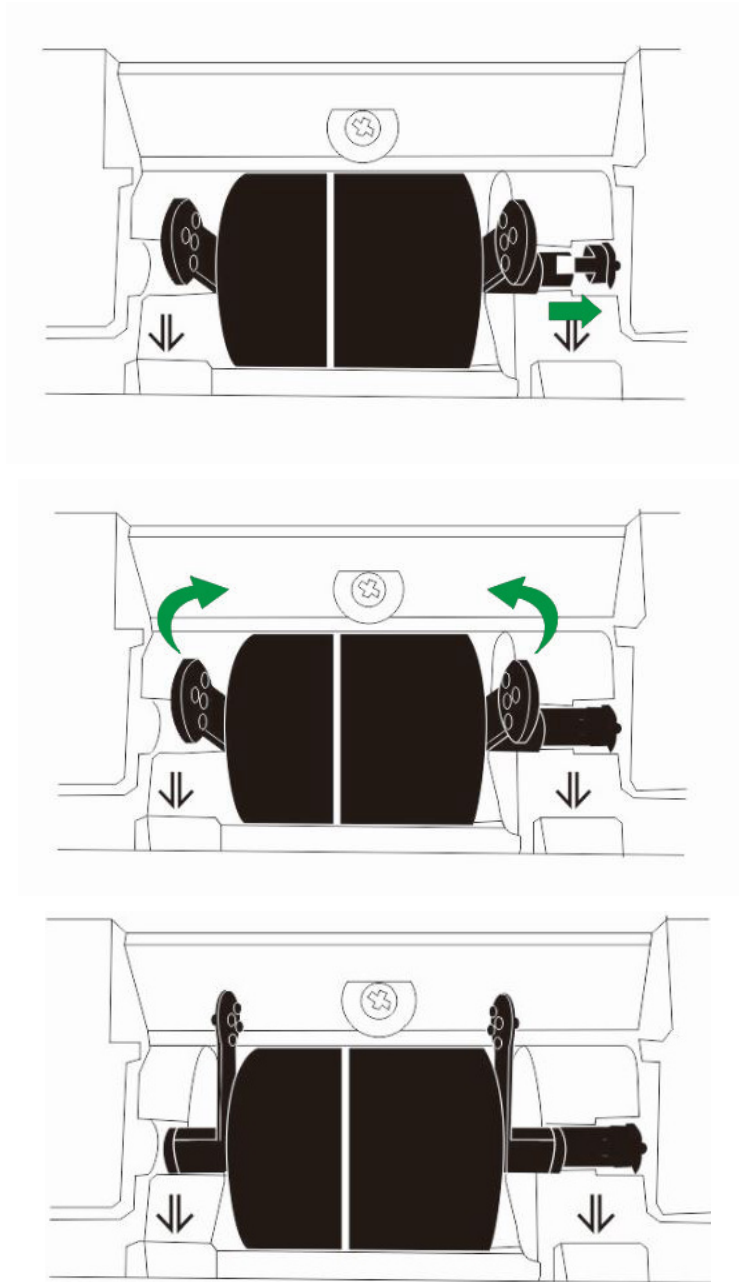



5. Install the paper chute by aligning and inserting the tabs of the paper chute into their slots on the scanner.

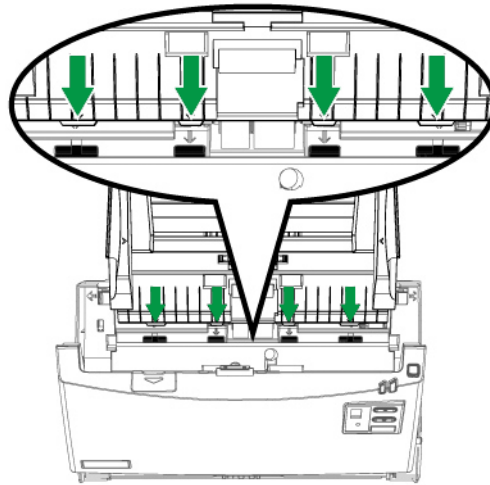

6. Close the ADF cover by pushing it back down until it snaps back into place.

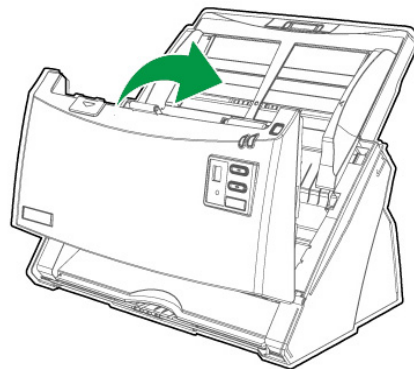

## CALIBRATING THE SCANNER

Calibrate the scanner if colors appear in areas that should be white, or colors of the scanned image and the original vary a lot. This allows you to adjust and compensate for variations that can occur in the optical component over time by its nature.

The following describes how to calibrate the scanner:

1. The Calibration Sheet, marked with an arrow on either edge at both sides, is used specially for **ADF Scanning** calibration.

2. Insert the special calibration sheet into the ADF of the scanner, with an arrow toward the scanner buttons.

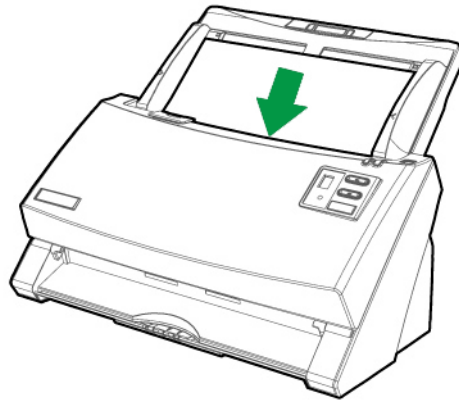

#### Attention

- Please insert the special calibration sheet included with the scanner. Alternatively you may also use any plain white sheet of paper sized in Letter / A4 instead; however, the calibration effect may be less good than the special calibration sheet.
- Save the Calibration Sheet in case you need to calibrate the scanner in the future.

3. Click **Start** > **All Programs** > **Your scanner model name** > **Calibration Wizard**. (For Windows 8.1 users: Point your mouse cursor to the upper or lower right corner of your screen to open the **Charm** bar. Click on the **Start** charm, then click on the downwards arrow button in the lower left corner of the screen. The **Apps** screen will be shown. Move your cursor to the right edge of the screen to scroll right until you find **Your scanner model name**, and then click on **Calibration Wizard**.)
4. Click **Next** from the Calibration Wizard that pops up and then click **Calibrate Now....**
5. Click on the **Start** button to begin the calibration process.
6. The scanner pulls the calibration sheet through the scanner, which completes this scanner calibration. After the calibration is complete, click **OK** and then click **Finish**.

## POWER SAVE

To save power consumption, when the scanning process is finished, the scanner light source will turn itself off and the scanner will enter a lower-power mode without delay time.



### Information

- You may disable the standby mode or define an idle time for the scanner to automatically enter the standby mode. You may press any scanner button to wake up the scanner from power saving.
- From the Windows **START** menu, point to **All Programs > Your Scanner Model Name**, and then click **Scanner Utility**. (For Windows 8.1 users: Point your mouse cursor to the upper or lower right corner of your screen to open the **Charm** bar. Click on the **Start** charm, then click on the downwards arrow button in the lower left corner of the screen. The **Apps** screen will be shown. Move your cursor to the right edge of the screen to scroll right until you find **Your scanner model name**, and then click on **Scanner Utility**.) Refer to the online help of Scanner Utility to explore more about standby mode.



# CHAPTER IV. TROUBLESHOOTING

If you encounter problems with your scanner, please review the installation and scanning instructions contained in this guide.

Before you ask for customer service or repair, please refer to the information in this chapter and consult our FAQ (Frequently Asked Questions) in which you can find useful self troubleshooting information. From the Windows **START** menu, point to **All Programs > Your Scanner Model Name**, and then click **FAQ**. (For Windows 8.1 users: Point your mouse cursor to the upper or lower right corner of your screen to open the **Charm** bar. Click on the **Start** charm, then click on the downwards arrow button in the lower left corner of the screen. The **Apps** screen will be shown. Move your cursor to the right edge of the screen to scroll right until you find **Your scanner model name**, and then click on **FAQ**.)

## SCANNER CONNECTION

The first step to take when troubleshooting connection problems with your scanner is to check all physical connections. The icon , located on the Windows system tray, indicates if the scanner software is properly launched and the scanner and computer are communicating with each other.

| Appearance  | Status  |
|---|---|
|  | The program has been successfully launched and the scanner is connected with the computer, ready to scan images.              |
|  | The scanner is not connected with the computer. Or, the scanner power is not switched on. Or, the scanner is in standby mode. |
| No Display  | You have chosen to terminate the program, no matter the scanner is connected or disconnected with the computer.               |

## CLEARING PAPER JAMS

If a paper jam in the ADF happens, please perform the following steps:

1. Remove any unjammed documents still loaded into the ADF.
2. Open the ADF cover by pulling the cover open lever.

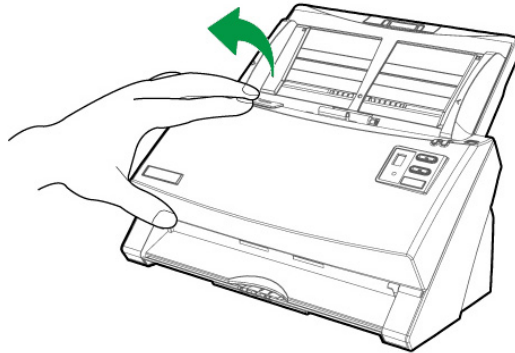

3. Gently but firmly pull the jammed documents out of the ADF. Try to avoid creasing or wrinkling the documents.

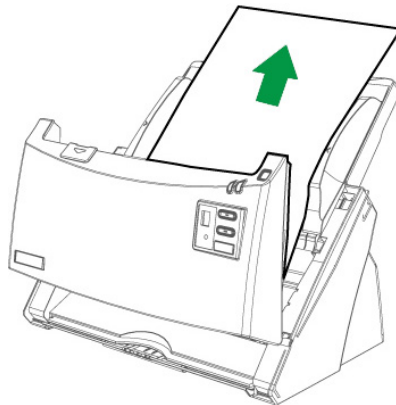

### Attention

Do not try to pull jammed or half-scanned documents out of the ADF without first opening the ADF cover. Doing so may permanently damage the ADF.

4. Close the ADF cover by pushing it back down until it snaps back into place.

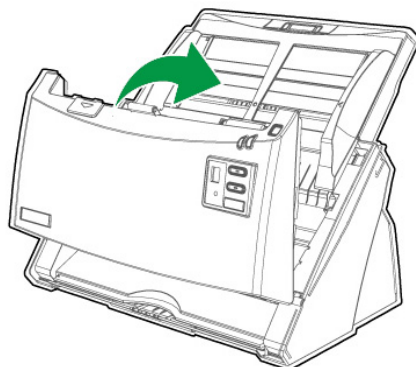

# APPENDIX A: SPECIFICATIONS<sup>11</sup>

|                                     |   |
|-------------------------------------|---|
| Image Sensor                        | CIS x 2   |
| Light Source                        | LED   |
| Optical Resolution                  | 600 dpi   |
| Hardware Resolution                 | 600 x 600 dpi   |
| Scan Modes                          | Color: Input 48-bit, Output 24-bit<br>Grayscale: Input 16-bit, Output 8-bit<br>Black & White: 1-bit   |
| ADF Capacity                        | 1. 100 sheets (A4/ Letter)<br>2. 30 sheets (Business Cards)<br>3. Plastic Card, Max. thickness under 1.2 mm.<br>Note: Maximum ADF capacity varies, depending upon paper weight. |
| Scanning Area (W x L)               | Max: 216 x 5080 mm (8.5" x 200")<br>Min: 13.2 x 13.2 mm (0.52" x 0.52")   |
| Acceptable Paper Sizes (W x L)      | Max: 216 x 5080 mm (8.5" x 200")<br>Min: 50.8 x 50.8 mm (2" x 2")   |
| Acceptable Paper Weight (Thickness) | 40 to 220 g/m <sup>2</sup> (10 to 58 Lbs)   |
| Multi-feed Detection <sup>12</sup>  | With ultrasonic technology <sup>13</sup>  |
| Roller Lifetime (Scans)             | 300,000   |
| Pad Lifetime (Scans)                | 100,000   |
| Action Button                       | 4 Buttons: Up, Down, Scan, Standby<br>9 function keys are all customizable.   |
| Power Supply                        | 24 Vdc/ 1.25 A or 24 Vdc/ 1.7 A   |
| Interface                           | USB 2.0 x 1, USB 2.0 (Host) x 1   |
| Net Weight                          | 2.7 Kgs (5.95 Lbs)  |
| Dimensions (W x D x H)              | 318.7 x 230.7 x 228.3 mm (12.55" x 9.08" x 8.99")   |

<sup>11</sup> Hardware specifications may change at any time without prior notice.

<sup>12</sup> This function may or may not be available depending on the scanner model you purchase.

<sup>13</sup> This function may or may not be available depending on the scanner model you purchase.

# APPENDIX B: CUSTOMER SERVICE AND WARRANTY

Please visit our website [www.plustek.com](http://www.plustek.com) for more customer service information.

To avoid delays, please have the following information available:

- Scanner name and model number
- Scanner serial number (Located at the bottom of the scanner)
- Scanner DVD version and part number
- A detailed description of the problem
- Your computer manufacturer and its model number
- The speed of your CPU
- Your current operating system and BIOS (optional)
- Name of software package(s), version or release number and manufacturer of the software
- Other USB devices installed

## SERVICE & SUPPORT INFORMATION

Where appropriate, the period of availability of spare parts and the possibilities of upgrading products information. Please ask local distributors and suppliers for spare parts information and product upgrade information.

Information requested by relevant Implementing Measure. Please ask local distributors and suppliers for the related information of Implementing Measure test report.

Do not dispose anything of products before you ask local distributors and suppliers to get correct information for decreases of environmental impact with right methods and procedures.

If you want to disposes the product and/or an accessory, please ask local distributors and suppliers to get the contact information of nearest disposal manufactures.

If you have any maintenance inquiry, please ask local distributors and suppliers to get the contact information of nearest maintenance center in order to extend the product usage life time.

If you want to maintain and clearance the product, please ask local distributors and suppliers to get the right information of nearest stores.

## STATEMENT OF LIMITED WARRANTY

This Statement of Limited Warranty applies only to the options you originally purchase for your use, and not for resale, from an authorized reseller.

The manufacturer warranty includes all parts and labor, and is not valid without the receipt of original purchase. To obtain warranty service, you may contact the authorized dealer or distributor, or visit our website to check out the available service information, or send a request via E-mail for further help.

If you transfer this product to another user, warranty service is available to that user for the remainder of the warranty period. You should give your proof of purchase and this statement to that user.

We warrant that this machine will be in good working order and will conform to its functional descriptions in the documentation provided. Upon provision of proof of purchase, replacement parts assume the remaining warranty of the parts they replace.

Before presenting this product for warranty service, you must remove all programs, data and removable storage media. Products returned without guides and software will be replaced without guides and software.

This Limited Warranty service does not provide for carry-in exchange when the problem results from accident, disaster, vandalism, misuse, abuse, unsuitable environment, program modification, another machine or non-vendor modification for this product.

If this product is an optional feature, this Limited Warranty applies only when the feature is used in a machine for which it was designed.

If you have any questions about your Limited Warranty, contact the approved retailer from whom you bought the product or the manufacturer.

THIS LIMITED WARRANTY REPLACES ALL OTHER WARRANTIES, EXPRESS OR IMPLIED, INCLUDING, BUT NOT LIMITED TO, THE IMPLIED WARRANTIES OF MERCHANTABILITY AND FITNESS FOR A PARTICULAR PURPOSE. HOWEVER, SOME LAWS DO NOT ALLOW THE EXCLUSION OF IMPLIED WARRANTIES. IF THESE LAWS APPLY, THEN ALL EXPRESS AND IMPLIED WARRANTIES ARE LIMITED IN DURATION TO THE WARRANTY PERIOD. NO OTHER WARRANTIES APPLY AFTER THAT PERIOD.

Some jurisdictions do not allow limitations on how long an implied warranty lasts, so the above limitation may not apply.

Under no circumstances are we liable for any of the following:

1. Third party claims against you for losses or damages.
2. Loss of, or damage to, your records or data; or
3. Economic consequential damages (including lost profits or savings) or incidental damages, even if we are informed of their possibility.



Some jurisdictions do not allow the exclusion or limitations of incidental or consequential damages, so the above limitation or exclusion may not apply to you.

This Limited Warranty gives you specific legal rights, and you may also have other rights that vary from jurisdiction to jurisdiction.

## **FCC RADIO FREQUENCY STATEMENT**

This equipment has been tested and found to comply with the limits for a Class B digital device, pursuant to part 15 of the FCC rules. These limits are designed to provide reasonable protection against harmful interference in a residential installation.

This equipment generates, uses and can radiate radio frequency energy and, if not installed and used in accordance with the instructions, may cause harmful interference to radio communications. However, there is no guarantee that interference will not occur in a particular television reception (which can be determined by turning the equipment off and on), the user is encouraged to try to correct the interference by one or more of the following measures:

- Reorient or relocate the receiving antenna.
- Increase the separation between the equipment and receiver.
- Connect the equipment to an outlet on a circuit different from that which the receiver is connected.
- Shielded interconnect cables and shielded power cord which are supplied with this equipment must be employed with this equipment to ensure compliance with the pertinent RF emission limits governing this device.
- Consult the dealer or an experienced radio/TV technician for help if the conditions persist.
- Changes or modifications not expressly approved by the manufacturer or authorized service center could void the user's authority to operate this equipment.

This device complies with Part 15 of the FCC Rules. Operation is subject to the following two conditions: (1) this device may not cause harmful interference, and (2) this device must accept any interference received, including interference that may cause undesired operation.