

Blueair Classic

User Manual - 500/600 series



Before using Blueair Classic 500 and 600 series, please read this user manual carefully.

Note:

There may be local variations of these models.

Contents

General	4
Overview of unit	5
Adjusting fan (air flow) speed	5
Safety information	6
Placing the unit	8
Getting started	8
Control panel and touch buttons	9
Blueair Friend mobile app settings	10
Filters	11
Changing the filters	12
Care and Maintenance	13
Classic 680i/605 technical specifications	14
Classic 505 technical specifications	15

General

Blueair 500/600 series

Blueair 500/600 series air purifiers are Wi-Fi enabled and are available in two models. The 680i models have built-in sensors for PM2.5, VOC, temperature/humidity, and the 605/505 models with no built-in sensors.

Adjustments to the air purifiers can be made manually anywhere and at any time, either via the touch buttons on the control panel located under the flip-up lid, or remotely via the Blueair Friend™ mobile app.

680i models

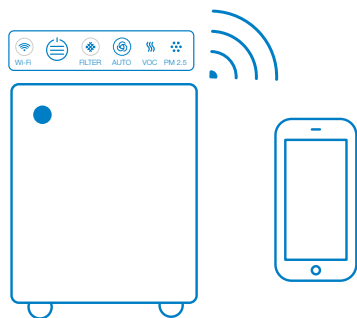

The air purifier can also be automatically regulated based on the air quality readings from the built-in sensors (680i), or the optional external air quality monitor Blueair Aware™ (605, 505)

For more information on how to use your air purifier together with the Blueair Aware air quality monitor, please see the Blueair Aware owner's manual and the support information.

605/505 models

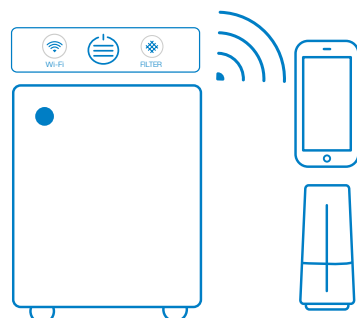

Overview of unit

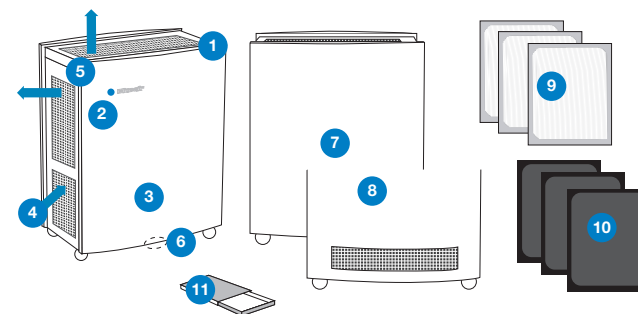

1. Control panel
2. Blue LED
3. Front cover
4. Air inlet
5. Air outlets
6. Sensor placement (680i)
7. Back view (505)
8. Back view (680i/605)
9. Particle filter, or Smokestop™ filter
10. Kit box
11. Kit box
 - welcome card
 - user manual
 - cleaning cloth

Adjusting fan (air flow) speed

Please refer to the table below to see the different options available for controlling your air purifier.

Control options	680i	605 (505)
Manual control via touch buttons on control panel		
Remotely via the Blueair Friend mobile app.		
Automode based on air quality readings from the built in sensors. This function may be activated either via the touch button on the control panel or via the Blueair Friend mobile app.		
Automode based on air quality readings from the external air quality monitor Blueair Aware. This function is activated via the Blueair Friend mobile app.		

Maximum speed is recommended for fast initial cleaning, during the day or when the air is heavily polluted. Minimum speed is recommended for nighttime use.

Safety information

The Blueair 605 (505) and 680i air purifiers are electrical appliances. Please read the safety instructions before use and take the necessary precautions to reduce the risk of fire, electric shock or injury.

The Blueair Limited Warranty applies only if the unit is used according to these instructions.



WARNING: Indicates a hazardous situation that, if not avoided, could result in death or serious injury.



CAUTION: Indicates a hazardous situation that, if not avoided, could result in minor or moderate injury.

General



WARNING: To avoid a hazard, a damaged supply cable must always be replaced by the manufacturer, service agent or similarly qualified person.

- Use the grounded power cable provided with your Blueair air purifier unit to plug directly into an appropriate, grounded electrical outlet. *(Refer to the rating label on your unit)*
- Do not alter the plug in any way.

Intended use



CAUTION: Supervise children to ensure that they do not play with the appliance.

- This appliance is not intended for use by persons (including children) with reduced physical, sensory or mental capabilities, or lack of experience and knowledge, unless they have been given supervision or instruction concerning use of the appliance by a person responsible for their safety.

Warning: Changes or modifications to this unit not expressly approved by the party responsible for compliance could void the user's authority to operate the equipment.

NOTE: This equipment has been tested and found to comply with the limits for a Class B digital device, pursuant to Part 15 of the FCC Rules. These limits are designed to provide reasonable protection against harmful interference in a residential installation. This equipment generates, uses and can radiate radio frequency energy and, if not installed and used in accordance with the instructions, may cause harmful interference to radio communications.

However, there is no guarantee that interference will not occur in a particular installation. If this equipment does cause harmful interference to radio or television reception, which can be determined by turning the equipment off and on, the user is encouraged to try to correct the interference by one or more of the following measures:

- Reorient or relocate the receiving antenna.
- Increase the separation between the equipment and receiver.
- Connect the equipment into an outlet on a circuit different from that to which the receiver is connected.
- Consult the dealer or an experienced radio/TV technician for help.

This device complies with Part 15 of the FCC Rules. Operation is subject to the following two conditions: (1) this device may not cause harmful interference, and (2) this device must accept any interference received, including interference that may cause undesired operation.

This device complies with Industry Canada licence-exempt RSS standard(s). Operation is subject to the following two conditions: (1) this device may not cause interference, and (2) this device must accept any interference, including interference that may cause undesired operation of the device.

This Class B digital apparatus complies with Canadian ICES-003.

FCC RF Radiation Exposure Statement Caution: This Transmitter must be installed to provide a separation distance of at least 20 cm from all persons.



FCC ID: 2AEX3-5XXZ-CC
IC: 20267-505

FCC ID: 2AEX3-6XXZ-CC
IC: 20267-605

Placing the unit



Place the unit in a location where air can circulate freely in, out and around the unit.



Do not place the unit near sources of heat, such as radiators, fireplaces or ovens.



Do not place the unit closer than 4" (10 cm) from another object.



Do not place the unit near wet areas, such as bathrooms or laundry rooms where it may come into contact with water.



Do not place the unit directly on or against soft furnishings such as bedding or linen.



Do not place the unit outdoors

Getting started

Connecting your air purifier - 680i, 605 and 505

Follow the instructions below to connect your air purifier to your Blueair Friend mobile app. You can then enable remote control.

Step 1

Plug the fixed power cable into a grounded wall outlet.

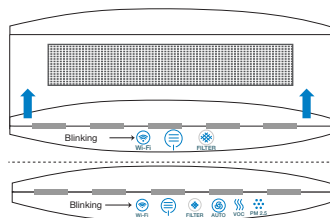
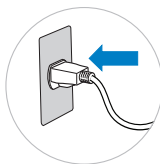

Open the flip-up lid and press the air-flow speed touch button. When the Wi-Fi symbol starts to blink, the air purifier can be paired with the Blueair Friend mobile app.

Step 2

Download the Blueair Friend mobile app to your smartphone from your app store (Apple App Store or Google Play).

Step 3

Connect your unit to your Blueair Friend mobile app. Start the app and follow the instructions.

After connecting your air purifier to the Blueair Friend mobile app, you can use the app to control the unit remotely and adjust settings.

Control panel and touch buttons

The control panel and touch buttons are located under the flip-up lid (see Step 2 "Starting up the unit"). A grey circle around a touch button indicates that it is inactive. When the unit is turned on, all touch buttons on the control panel (except for airflow speed control); will dim down after 20 seconds. Tap the control panel and the touch buttons will light up again.

Classic 605 (505) control panel touch buttons



Wi-Fi
Status grey - OFF (no Wi-Fi)



Status 1 blue bar - minimum speed



Status "blinking" - no connection.
Wi-Fi ready to be connected.



Status 2 blue bars - medium speed



Status grey and blue
Wi-Fi connected



Status 3 blue bars - maximum speed



Air flow speed control
Status grey - OFF



Filter
Status grey and blue -no replacement filter currently needed.



Status blue and all bars are grey -
the power cable is plugged in.



Status orange - replace filter and
reset by pressing down for 5 seconds.

Classic 680i control panel touch buttons



Auto speed

Status circle blue - unit is on
 Status symbol grey - Auto speed OFF
 Status symbol blue - Auto speed ON



VOC indicator

Status blue - from excellent to moderate pollution levels
 Status orange - from slight to high pollution levels

See Blueair Friend mobile app for further information regarding pollution and threshold levels.



PM2.5 indicator

Status blue - from excellent to moderate pollution levels.
 Status orange - from slight to high pollution levels

Blueair Friend mobile app settings

Please note that you must first add your air purifier unit to the Blueair Friend mobile app before you can control the following settings via the app:



Adjust airflow speed

Changes the fan speed between speed 1, 2 and 3.



Adjust LED intensity

Changes the LED intensity for those lamps that are visible.



Child lock

Regulates your ability to control the air purifier unit via the control panel on the unit.



Auto mode

Automatically controls the fan speed based on readings either from the built-in sensors ("i" models only), or from the external air quality monitor Blueair Aware.



Night mode

Allows the activation/deactivation of certain settings at specific times.

Filters

General information

The unit is delivered with three HEPASilent™ filters already installed.

Particle filters remove:



PM2.5



Dust



Pollen



Pet dander



Mold



Particles

Smokestop™ filters remove all the above pollutants, plus:



Dust mites



Bacteria



VOC



Smoke



Chemicals



Cooking odors

IMPORTANT! Use only genuine Blueair filters to ensure proper function of your unit and to qualify for full warranty coverage.

Filter checklist

To make it easy to find the right filter in the future, please fill in the customer record below and keep this user manual for reference. The model number and serial number of this product can be found on the rating label on the bottom of the unit.

Model number _____ **Retailer's name** _____
Serial number _____ **Retailer's address** _____
Date of purchase _____ **Telephone number** _____

Blueair filter subscription program

This convenient service is available in some countries – contact your local Blueair retailer to find out if you can join.

Changing the filters

IMPORTANT!

Always turn off and disconnect the unit from the supply mains before changing filters, cleaning or carrying out maintenance procedures.

Step 1

Remove the lid.
(see "Care and Maintenance step 1).

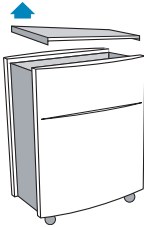

Step 2

Remove the top filter.

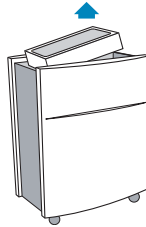

Step 3

Remove both side filters. (see "Care and Maintenance steps 2 and 3).

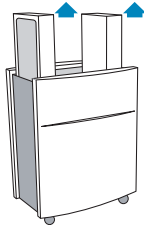

Step 4

Insert both replacement Blueair filters into the side slots. Ensure the words **out/up** face **outwards**.

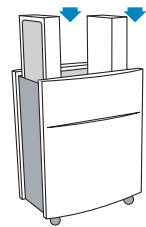

Step 5

Insert the third replacement Blueair filter into the top of the unit. Ensure the words **out/up** face **upwards**

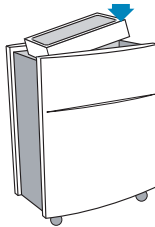

Step 6

Snap the lid back into place and plug into the mains.
The unit is now ready for use.

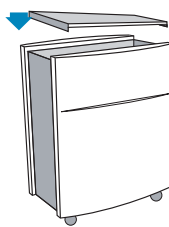

Status orange - replace filter and reset by pressing down for 5 seconds.

Care and maintenance

We recommend routine cleaning in order to keep your unit in top condition.

When changing filters

1. Wipe clean the underside of the lid after removal.
2. Vacuum the air inlet grille from the inside using a soft brush and/or other suitable attachment.
3. Vacuum the small air inlets with a soft brush attachment.

General

1. Wipe the exterior of the unit with a soft, clean, damp cloth.
2. Never clean with gasoline, chemical solvents or corrosive material as these agents may damage the surface.
3. Do not allow foreign objects to enter the ventilation or exhaust openings. This may cause electric shock or damage the unit.
4. Do not try to repair or adjust any of the electrical or mechanical functions on your Blueair unit yourself. Contact your local dealer or Blueair for warranty information.



Help and support

If you have questions about **Blueair Classic series**, please visit www.blueair.com or contact your local Blueair retailer.

Warranty information

The Blueair Limited Warranty applies only if the unit is used according to the instructions in this manual.



Classic 680i/605 technical specifications*

CADR (cfm)**:	Smoke  500	Dust  500	Pollen  640
Room size	775 sq.ft. (72 m²)		
Air Changes per Hour ***	5		
Airflow (Speed 1-2-3)	150-275-650 cfm		
Size (HxWxD):	26 x 20 x 13 in. (660 x 500 x 340 mm)		
Product weight:	35 lbs (16 kg)		
Energy consumption (Speed 1-2-3)****	15-65-105 W		
Sound pressure levels (Speed 1-2-3)	33-44-62 dB(A)		
Filter replacement indicator	Yes		
Speed control options	680i 605	1-2-3, non-touch, smartphone (Automode) 1-2-3, non-touch, smartphone	
Air quality sensors	680i 605	Built-in sensors for VOC, PM2.5, temperature and humidity No sensors - optional use with Blueair Aware	
The entire unit can be recycled.			

External network issues affecting the product performance are beyond the control of Blueair. Please contact your Internet service provider for assistance.

- * Specifications based on U.S. models (120 VAC, 60 Hz with particle filter)
- ** The CADR indicates how much filtered air is delivered (airflow) by the air purifier operating at the highest setting, and how well the system removes tobacco smoke, dust and pollen pollutants from the air (efficiency). Tests are performed in accordance with ANSI/AHAM AC-1. The maximum possible CADR ratings according to this standard are: Tobacco Smoke: 450 cfm. / Dust: 400 cfm. / Pollen: 450 cfm.
- *** Air changes per hour are calculated on the recommended room size, assuming 8-foot (2.4 m) ceilings. For smaller rooms, the air changes per hour will increase.
- **** The available electrical power voltage and frequency affects the power consumption of the unit. The power consumption might therefore be different from the stated value.

Classic 505 technical specifications*

CADR (cfm)**:	Smoke  400	Dust  450	Pollen  450
Room size	698 sq.ft. (65 m²)		
Air Changes per Hour***	5		
Airflow (Speed 1-2-3)	130-240-520 cfm		
Size (HxWxD):	26 x 20 x 13 in. (660 x 500 x 340 mm)		
Product weight:	35 lbs (16 kg)		
Energy consumption (Speed 1-2-3)****	15-65-105 W		
Sound pressure levels (Speed 1-2-3)	33-44-62 dB(A)		
Filter replacement indicator	Yes		
Speed control options	1-2-3, non-touch, smartphone (Automode)		
Air quality sensors	No sensors - optional use with Blueair Aware The entire unit can be recycled.		

External network issues affecting the product performance are beyond the control of Blueair. Please contact your Internet service provider for assistance.

- * Specifications based on U.S. models (120 VAC, 60 Hz with particle filter)
- ** The CADR indicates how much filtered air is delivered (airflow) by the air purifier operating at the highest setting, and how well the system removes tobacco smoke, dust and pollen pollutants from the air (efficiency). Tests are performed in accordance with ANSI/AHAM AC-1. The maximum possible CADR ratings according to this standard are: Tobacco Smoke: 450 cfm. / Dust: 400 cfm. / Pollen: 450 cfm.
- *** Air changes per hour are calculated on the recommended room size, assuming 8-foot (2.4 m) ceilings. For smaller rooms, the air changes per hour will increase.
- **** The available electrical power voltage and frequency affects the power consumption of the unit. The power consumption might therefore be different from the stated value.



www.blueair.com

Blueair AB

Danderydsgatan 11
SE-114 26 Stockholm
Sweden

Tel: +46 8 679 45 00
Fax: +46 8 679 45 45
info@blueair.se

Blueair Inc.

Suite 1900,
100 N LaSalle Street
Chicago, IL 60602

Tel: +1 888 258 3247
Fax: +1 312 727 1153
info@blueair.com

Blueair India Pvt. Ltd.

Embassy of Sweden
Nyaya Marg, Chanakyapuri
New Dehli – 110021

Tel: +91 11 4606 7121
Fax: +91 11 4606 7120
india@blueair.se

Blueair (Shanghai) Trading Co. Ltd.

Rm 1005 City Gateway
No. 398 North Caoxi Road
Xuhui Distr, Shanghai

Tel: +86 21 6091 0981
Fax: +86 21 6091 0989
info@blueair.cn